

This copy is a reprint which includes current pages from Change 1.

ARMY TM **5-818-5**
NAVY NAVFAC **P-418**
AIR FORCE **AFM** 88-5, Chap 6

DEWATERING
AND
GROUNDWATER CONTROL

DEPARTMENTS OF THE ARMY, THE NAVY, AND THE AIR FORCE
NOVEMBER 1983

REPRODUCTION **AUTHORIZATION/RESTRICTIONS**

This manual has been prepared by or for the Government and, except to the extent indicated below, is public property and not subject to copyright.

Copyrighted material included in the manual has been used with the knowledge and permission of the proprietors and is acknowledged as such at point of use. Anyone wishing to make further use of any copyrighted material, *by itself and apart from this text*, should seek necessary permission directly from the proprietors.

Reprints or republications of this manual should include a credit substantially as follows: "Joint Departments of the Army, the Air Force, and the Navy, USA, Technical Manual TM 5-818-5/AFM 88-5, Chap 6/NAVFAC P-418, Dewatering and Groundwater Control."

If the reprint or republication includes *copyrighted* material, the credit should also state: "Anyone wishing to make further use of copyrighted material, *by itself and apart from this text*, should seek necessary permission directly from the proprietors."

HEADQUARTERS
DEPARTMENTS OF THE ARMY,
AIR FORCE, AND NAVY
WASHINGTON, DC 27 June 1985

Change }
No. 1 }

DEWATERING AND GROUNDWATER CONTROL

TM 5-818-5/AFM 88-5, Chapter 6/NAVFAC P-418, 15 November 1983 is changed as follows:

1. Remove old pages and insert new pages as indicated below. New or changed material is indicated by a vertical bar in the margin of the page.

<i>Remove pages</i>	<i>Insert pages</i>
i and ii	i and iii
A-1	A-1

2. File this change sheet in front of the publication for reference purposes.

By Order of the Secretaries of the Army, the Air Force, and the Marine Corps:

JOHN A. WICKHAM, JR.
General, United States Army
Chief of Staff

Official:

DONALD J. DELANDRO
Brigadier General, United States Army
The Adjutant General

CHARLES A. GABRIEL
General, United States Air Force
Chief of Staff

Official:

EARL T. O'LOUGHLIN
General, United States Air Force,
Commander, Air Force
Logistics Command

H.A. HATCH
Lieutenant General, Marine Corps
Deputy Chief of Staff, Installation
and Logistics Command

TECHNICAL MANUAL
No. 5-818-5
AIR FORCE MANUAL
No. 88-5, Chapter 6
NAVY MANUAL
No. P-418

HEADQUARTERS
DEPARTMENT OF THE ARMY,
THE AIR FORCE,
AND THE NAVY

WASHINGTON, DC 15 November 1983

DEWATERING AND GROUNDWATER CONTROL

CHAPTER		Paragraph	Page
1.	INTRODUCTION		
	Purpose and scope	1-1	1-1
	General	1-2	1-1
	Construction dewatering	1-3	1-1
	Permanent groundwater control	1-4	1-2
2.	METHODS FOR DEWATERING, PRESSURE RELIEF, AND SEEPAGE CUTOFF		
	General	2-1	2-1
	Types and source of seepage	2-2	2-1
	Sumps and ditches	2-3	2-1
	Wellpoint systems	2-4	2-2
	Deep-well systems	2-5	2-4
	Vertical sand drains	2-6	2-5
	Electro-osmosis	2-7	2-5
	Cutoffs	2-8	2-5
	Summary of groundwater control methods	2-9	2-8
	Selection of dewatering system	2-10	2-8
3.	GEOLOGIC, SOIL, AND GROUNDWATER INVESTI- GATIONS		
	General	3-1	3-1
	Geologic and soil conditions	3-2	3-1
	Groundwater characteristics	3-3	3-4
	Permeability of pervious strata	3-4	3-4
	Power	3-5	3-8
	Surface water	3-6	3-8
4.	DESIGN OF DEWATERING, PRESSURE RELIEF, AND GROUNDWATER CONTROL SYSTEMS		
	Analysis of groundwater flow	4-1	4-1
	Mathematical and model analyses	4-2	4-1
	Flow-net analyses	4-3	4-29
	Electrical analogy seepage models	4-4	4-29
	Numerical analyses	4-5	4-34
	Wellpoints, wells, and filters	4-6	4-34
	Pumps, headers, and discharge pipes	4-7	4-36
	Factors of safety	4-8	4-40
	Dewatering open excavations	4-9	4-42
	Dewatering shafts and tunnels	4-10	4-47
	Permanent pressure relief systems	4-11	4-48
	Freezing	4-12	4-48
	Control of surface water	4-13	4-49
5.	INSTALLATION OF DEWATERING AND GROUND- WATER CONTROL SYSTEMS		
	General	5-1	5-1
	Deep-well systems	5-2	5-1
	Wellpoint systems	5-3	5-2
	Vertical sand drains	5-4	5-5
	Cutoffs	5-5	5-5
	Piezometers	5-6	5-6
6.	OPERATION AND PERFORMANCE CONTROL		
	General	6-1	6-1
	Operation	6-2	6-1
	Control and evaluation of performance	6-3	6-2
7.	CONTRACT SPECIFICATIONS		
	General	7-1	7-1

*This manual supersedes TM 5-818-5/AFM 88-5, Chap 6/NAVFAC P-418, April 1971.

	<i>Paragraph</i>	<i>Page</i>
	Types of specifications	7-2 7-1
	Data to be included in specifications	7-3 7-2
	Dewatering requirements and specifications	7-4 7-2
	Measurement and payment	7-5 7-3
	Examples of dewatering specifications	7-6 7-3
■ APPENDIX A.	REFERENCES AND BIBLIOGRAPHY	A-1
B.	NOTATIONS	B-1
C.	FIELD PUMPING TESTS	C-1
D.	EXAMPLES OF DESIGN OF DEWATERING AND PRES- SURE RELIEF SYSTEMS	D-1
E.	TRANSFORMATION OF ANISOTROPIC SOIL CONDITIONS TO ISOTROPIC SOIL CONDITIONS	E-1
F.	WELL AND TOTAL DISCHARGE MEASUREMENTS	F-1
G.	EXAMPLES OF DETAILED DEWATERING SPECIFICA- TIONS	G-1

LIST OF FIGURES

<i>Figure</i>		<i>Page</i>
1-1	Installation of piezometers for determining water table and arte- sian hydrostatic pressure	1-2
1-2	Permanent groundwater control system	1-3
2-1	Dewatering open excavation by ditch and sump	2-2
2-2	Self-jetting wellpoint	2-3
2-3	Use of wellpoints where submergence is small	2-4
2-4	Drainage of an open deep cut by means of a multistage wellpoint system	2-4
2-5	Vacuum wellpoint system	2-5
2-6	Jet-eductor wellpoint system for dewatering a shaft	2-6
2-7	Deep-well system for dewatering an excavation in sand	2-7
2-8	Deep wells with auxiliary vacuum system for dewatering a shaft in stratified materials	2-8
2-9	Sand drains for dewatering a slope	2-9
2-10	Electro-osmotic wellpoint system for stabilizing an excavation slope	2-9
2-11	Grout curtain or cutoff trench around an excavation	2-10
2-12	Dewatering systems applicable to different soils	2-13
2-13	Recharge of groundwater to prevent settlement of a building as a result of dewatering operations	2-14
3-1	Geologic profile developed from geophysical explorations	3-2
3-2	Permeameters: (a) constant head and (b) falling head	3-3
3-3	Specific yield of water-bearing sands versus D_{10} , South Coastal Basin, California	3-4
3-4	D_{10} versus in situ coefficient of permeability—Mississippi River Valley and Arkansas River Valley	3-6
3-5	Formulas for determining permeability from field falling head tests	3-7
3-6	Inches of rainfall during 10- and 30-minute and 1-hour periods ...	3-8
4-1	Flow and head for fully penetrating line slot; single-line source; artesian, gravity, and combined flows	4-2
4-2	Height of free discharge surface h_s ; gravity flow	4-3
4-3	Flow and head for partially penetrating line slot; single-line source; artesian, gravity, and combined flows	4-4
4-4	Flow and head for fully and partially penetrating line slot; two- line source; artesian and gravity flows	4-5
4-5	Flow and head (midway) for two partially penetrating slots; two- line source; artesian and gravity flows	4-6
4-6	Flow and head for fully and partially penetrating circular slots; circular source; artesian flow	4-7
4-7	Head at center of fully and partially penetrating circular slots; cir- cular source; artesian flow	4-8
4-8	Flow and drawdown at slot for fully and partially penetrating rec- tangular slots; circular source; artesian flow	4-9
4-9	Head within a partially penetrating rectangular slot; circular source; artesian flow	4-10
4-10	Flow and drawdown for fully and partially penetrating single wells; circular source; artesian flow	4-11

<i>Figure</i>		<i>Page</i>
4-11	Flow and drawdown for fully and partially penetrating single wells; circular source; gravity flow	4-12
4-12	Flow and drawdown for fully penetrating single well; circular source; combined artesian and gravity flows	4-13

CHAPTER 1

INTRODUCTION

1-1. Purpose and scope. This manual provides guidance for the planning, design, supervision, construction, and operation of dewatering and pressure relief systems and of seepage cutoffs for deep excavations for structures. It presents: description of various methods of dewatering and pressure relief; techniques for determining groundwater conditions, characteristics of pervious aquifers, and dewatering requirements; guidance for specifying requirements for dewatering and seepage control measures; guidance for determining the adequacy of designs and plans prepared by contractors; procedures for designing, installing, operating, and checking the performance of dewatering systems for various types of excavations; and descriptions and design of various types of cutoffs for controlling groundwater.

1-2. General.

a. It will generally be the responsibility of the contractor to design, install, and operate dewatering and groundwater control systems. The principal usefulness of this manual to design personnel will be those portions devoted to selecting and specifying dewatering and groundwater control systems. The portions of the manual dealing with design considerations should facilitate review of the contractor's plans for achieving the desired results.

b. Most of the analytical procedures set forth in this manual for groundwater flow are for "steady-state" flow and not for "unsteady-state" flow, which occurs during the initial phase of dewatering.

c. Some subsurface construction may require dewatering and groundwater control procedures that are not commonly encountered by construction contractors, or the dewatering may be sufficiently critical as to affect the competency of the foundation and design of the substructure. In these cases, it may be desirable to design and specify the equipment and procedures to be used and to accept responsibility for results obtained. This manual should assist design personnel in this work.

1-3. Construction dewatering.

a. *Need for groundwater control.* Proper control of groundwater can greatly facilitate construction of subsurface structures founded in, or underlain by, pervious soil strata below the water table by:

(1) Intercepting seepage that would otherwise emerge from the slopes or bottom of an excavation.

(2) Increasing the stability of excavated slopes and preventing the loss of material from the slopes or bottom of the excavation.

(3) Reducing lateral loads on cofferdams.

(4) Eliminating the need for, or reducing, air pressure in tunneling.

(5) Improving the excavation and backfill characteristics of sandy soils.

Uncontrolled or improperly controlled groundwater can, by hydrostatic pressure and seepage, cause piping, heave, or reduce the stability of excavation slopes or foundation soils so as to make them unsuitable for supporting the structure. For these reasons, subsurface construction should not be attempted or permitted without appropriate control of the groundwater and (subsurface) hydrostatic pressure.

b. *Influence of excavation characteristics.* The location of an excavation, its size, depth, and type, such as open cut, shaft, or tunnel, and the type of soil to be excavated are important considerations in the selection and design of a dewatering system. For most granular soils, the groundwater table during construction should be maintained at least 2 to 3 feet below the slopes and bottom of an excavation in order to ensure "dry" working conditions. It may need to be maintained at lower depths for silts (5 to 10 feet below sub grade) to prevent water pumping to the surface and making the bottom of the excavation wet and spongy. Where such deep dewatering provisions are necessary, they should be explicitly required by the specifications as they greatly exceed normal requirements and would not otherwise be anticipated by contractors.

(1) Where the bottom of an excavation is underlain by a clay, silt, or shale stratum that is underlain by a pervious formation under artesian pressure (fig. 1-1), the upward pressure or seepage may rupture the bottom of the excavation or keep it wet even though the slopes have been dewatered. Factor of safety considerations with regard to artesian pressure are discussed in paragraph 4-8.

(2) Special measures may be required for excavations extending into weathered rock or shale where substantial water inflow can be accommodated without severe erosion. If the groundwater has not been controlled by dewatering and there is appreciable flow

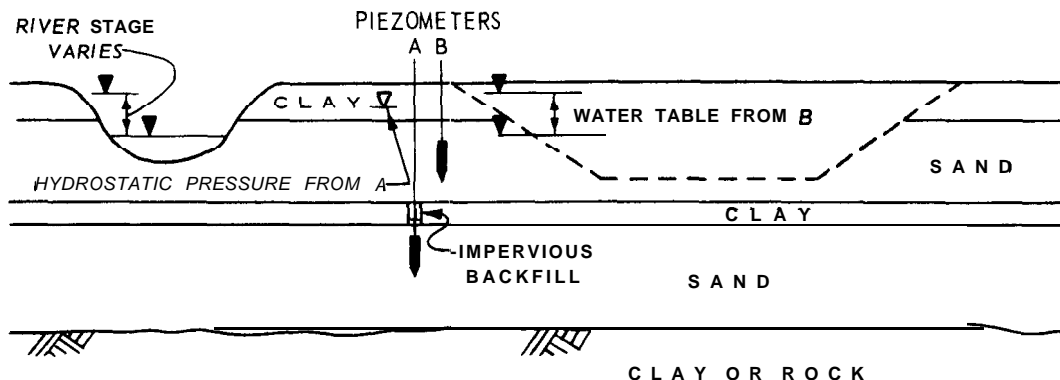

(Modified from "Foundation Engineering," G. A. Leonards, ed., 1962, McGraw-Hill Book Company. Used with permission of McGraw-Hill Book Company.)

Figure 1-1. Installation of piezometers for determining water table and artesian hydrostatic pressure.

or significant hydrostatic pressures within the rock or shale deposit, rock anchors, tiebacks, and lagging or bracing may be required to prevent heave or to support exposed excavation slopes.

(3) An important facet of dewatering an excavation is the relative risk of damage that may occur to the excavation, cofferdam, or foundation for a structure in event of failure of the dewatering system. The method of excavation and reuse of the excavated soil may also have a bearing on the need for dewatering. These factors, as well as the construction schedule, must be determined and evaluated before proceeding with the design of a dewatering system.

c. *Groundwater control methods.* Methods for controlling groundwater may be divided into three categories:

(1) Interception and removal of groundwater from the site by pumping from sumps, wells, wellpoints, or drains. This type of control must include consideration of a filter to prevent migration of fines and possible development of piping in the soil being drained.

(2) Reduction of artesian pressure beneath the bottom of an excavation.

(3) Isolation of the excavation from the inflow of groundwater by a sheet-pile cutoff, grout curtain, slurry cutoff wall, or by freezing.

1-4. Permanent groundwater control. Many factors relating to the design of a temporary dewatering or pressure relief system are equally applicable to the design of permanent groundwater control systems. The principal differences are the requirements for permanency and the need for continuous operation. The requirements for permanent drainage systems depend largely on the structural design and operational requirements of the facility. Since permanent groundwater control systems must operate continuously without interruption, they should be conservatively designed and mechanically simple to avoid the need for complicated control equipment subject to failure and the need for operating personnel. Permanent drainage systems should include provisions for inspection, maintenance, and monitoring the behavior of the system in more detail than is usually required for construction dewatering systems. Permanent systems should be conservatively designed so that satisfactory results are achieved even if there is a rise in the groundwater level in the surrounding area, which may occur if water supply wells are shut down or if the efficiency of the dewatering system decreases, as may happen if bacteria growth develops in the filter system. An example of a permanent groundwater control system is shown in figure 1-2.

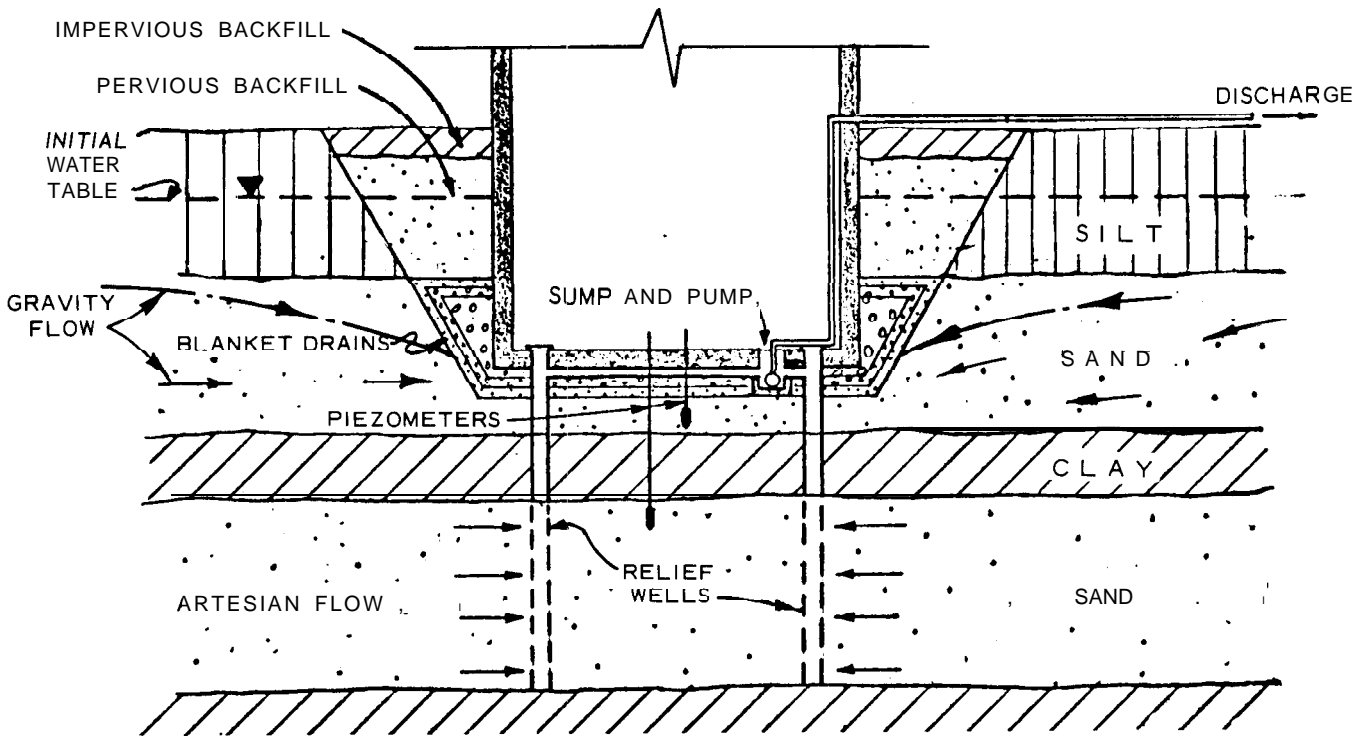

U. S. Army Corps of Engineers

(Fruco & Associates, Inc.)

Figure 1-2. Permanent groundwater control system.

CHAPTER 2

METHODS FOR DEWATERING, PRESSURE RELIEF, AND SEEPAGE CUTOFF

2-1. General.

a. Tempomry dewatering systems. Dewatering and control of groundwater during construction may be accomplished by one or a combination of methods described in the following paragraphs. The applicability of different methods to various types of excavations, groundwater lowering, and soil conditions is also discussed in these paragraphs. Analysis and design of dewatering pressure relief and groundwater control systems are described in chapter 4.

b. Permanent dminuge systems. The principles and methods of groundwater control for permanent structures are similar to those to be described for construction projects. A method often used for permanent groundwater control consists of relief wells (to be discussed subsequently in detail) installed beneath and adjacent to the structure, with drainage blankets beneath and surrounding the structure at locations below the water table as shown previously in figure 1-2. The water entering the wells and drainage blanket is carried through collector pipes to sumps, pits, or man-holes, from which it is pumped or drained. Permanent groundwater control may include a combination of wells, cutoffs, and vertical sand drains. Additional information on the design of permanent drainage systems for buildings may be found in TM 5-818-1/AFM 88-3, Chapter 7; TM 5-818-4/AFM 88-5, Chapter 5; and TM 5-818-6/AFM 88-32. (See app. A for references.)

2-2. Types and source of seepage.

a. Types of seepage flow. Types of seepage flow are tabulated below:

<i>Type of flow</i>	<i>Flow characteristics</i>
Artesian	Seepage through the previous aquifer is confined between two or more impervious strata, and the piezometric head within the previous aquifer is above the top of the pervious aquifer (fig. 1-2).
Gravity	The surface of the water table is below the top of the pervious aquifer (fig. 1-2).

For some soil configurations and drawdowns, the flow may be artesian in some areas and gravity in other areas, such as near wells or sumps where drawdown occurs. The type of seepage flow to a dewatering system can be determined from a study of the ground-

water table and soil formations in the area and the drawdown required to dewater the excavation.

b. Source of seepage flow. The source and distance L^* to the source of seepage or radius of influence R must be estimated or determined prior to designing or evaluating a dewatering or drainage system.

(1) The source of seepage depends on the geological features of the area, the existence of adjacent streams or bodies of water, the perviousness of the sand formation, recharge, amount of drawdown, and duration of pumping. The source of seepage may be a nearby stream or lake, the aquifer being drained, or both an adjacent body of water and storage in the aquifer.

(2) Where the site is not adjacent to a river or lake, the source of seepage will be from storage in the formation being drained and recharged from rainfall over the area. Where this condition exists, flow to the area being dewatered can be computed on the assumption that the source of seepage is circular and at a distance R . The radius of influence R is defined as the radius of the circle beyond which pumping of a dewatering system has no significant effect on the original groundwater level or piezometric surface (see para 4-2a(3)).

(3) Where an excavation is located close to a river or shoreline in contact with the aquifer to be dewatered, the distance to the effective source of seepage L , if less than $R/2$, may be considered as being approximately the near bank of the river; if the distance to the riverbank or shoreline is equal to about $R/2$, or greater, the source of seepage can be considered a circle with a radius somewhat less than R .

(4) Where a line or two parallel lines of wells are installed in an area not close to a river, the source of seepage may be considered as a line paralleling the line of wells.

2-3. Sumps and ditches.

a. Open excavations. An elementary dewatering procedure involves installation of ditches, French drains, and sumps within an excavation, from which water entering the excavation can be pumped (fig. 2-1). This method of dewatering generally should not

*For convenience, symbols and unusual abbreviations are listed in the Notation (app B).

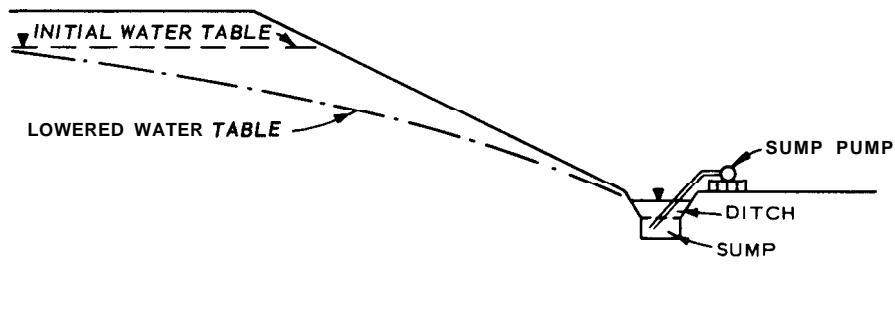

(Modified from "Foundation Engineering," G.A. Leonards, ed., 1962, McGraw-Hill Book Company. Used with permission of McGraw-Hill Book Company.)

Figure 2-1. Dewatering open excavation by ditch and sump.

be considered where the groundwater head must be lowered more than a few feet, as seepage into the excavation may impair the stability of excavation slopes or have a detrimental effect on the integrity of the foundation soils. Filter blankets or drains may be included in a sump and ditch system to overcome minor raveling and facilitate collection of seepage. Disadvantages of a sump dewatering system are slowness in drainage of the slopes; potentially wet conditions during excavation and backfilling, which may impede construction and adversely affect the **subgrade** soil; space required in the bottom of the excavation for drains, ditches, sumps, and pumps; and the frequent lack of workmen who are skilled in the proper construction or operation of sumps.

b. Cofferdams. A common method of excavating below the groundwater table in confined areas is to drive wood or steel sheet piling below **subgrade** elevation, install bracing, excavate the earth, and pump out any seepage that enters the cofferdammed area.

(1) Dewatering a sheeted excavation with sumps and ditches is subject to the same limitations and serious disadvantages as for open excavations. However, the danger of hydraulic heave in the bottom of an excavation in sand may be reduced where the sheeting can be driven into an underlying impermeable stratum, thereby reducing the seepage into the bottom of the excavation.

(2) Excavations below the water table can sometimes be successfully made using sheeting and sump pumping. However, the sheeting and bracing must be designed for hydrostatic pressures and reduced toe support caused by upward seepage forces. Covering the bottom of the excavation with an inverted sand and gravel filter blanket will facilitate construction and pumping out seepage water.

2-4. Wellpoint systems. Wellpoint systems are a commonly used dewatering method as they are appli-

cable to a wide range of excavations and groundwater conditions.

a. Conventional wellpoint systems. A conventional wellpoint system consists of one or more stages of wellpoints having 1% or 2-inch-diameter riser pipes, installed in a line or ring at spacings between about 3 and 10 feet, with the risers connected to a common header pumped with one or more wellpoint pumps. Wellpoints are small well screens composed of either brass or stainless steel mesh, slotted brass or plastic pipe, or trapezoidal-shaped wire wrapped on rods to form a screen. They generally range in size from 2 to 4 inches in diameter and 2 to 5 feet in length and are constructed with either closed ends or self-jetting tips as shown in figure 2-2. They may or may not be surrounded with a filter depending upon the type of soil drained. Wellpoint screens and riser pipes may be as large as 6 inches and as long as 25 feet in certain situations. A wellpoint pump uses a combined vacuum and a centrifugal pump connected to the header to produce a vacuum in the system and to pump out the water that drains to the wellpoints. One or more supplementary vacuum pumps may be added to the main pumps where additional air handling capacity is required or desirable. Generally, a stage of wellpoints (wellpoints connected to a header at a common elevation) is capable of lowering the groundwater table about 15 feet; lowering the groundwater more than 15 feet generally requires a multistage installation of wellpoints as shown in figures 2-3 and 2-4. A wellpoint system is usually the most practical method for dewatering where the site is accessible and where the excavation and water-bearing strata to be drained are not too deep. For large or deep excavations where the depth of excavation is more than 30 or 40 feet, or where artesian pressure in a deep aquifer must be reduced, it may be more practical to use eductor-type wellpoints or deep wells (discussed subsequently) with turbine or submersible pumps, using wellpoints as a

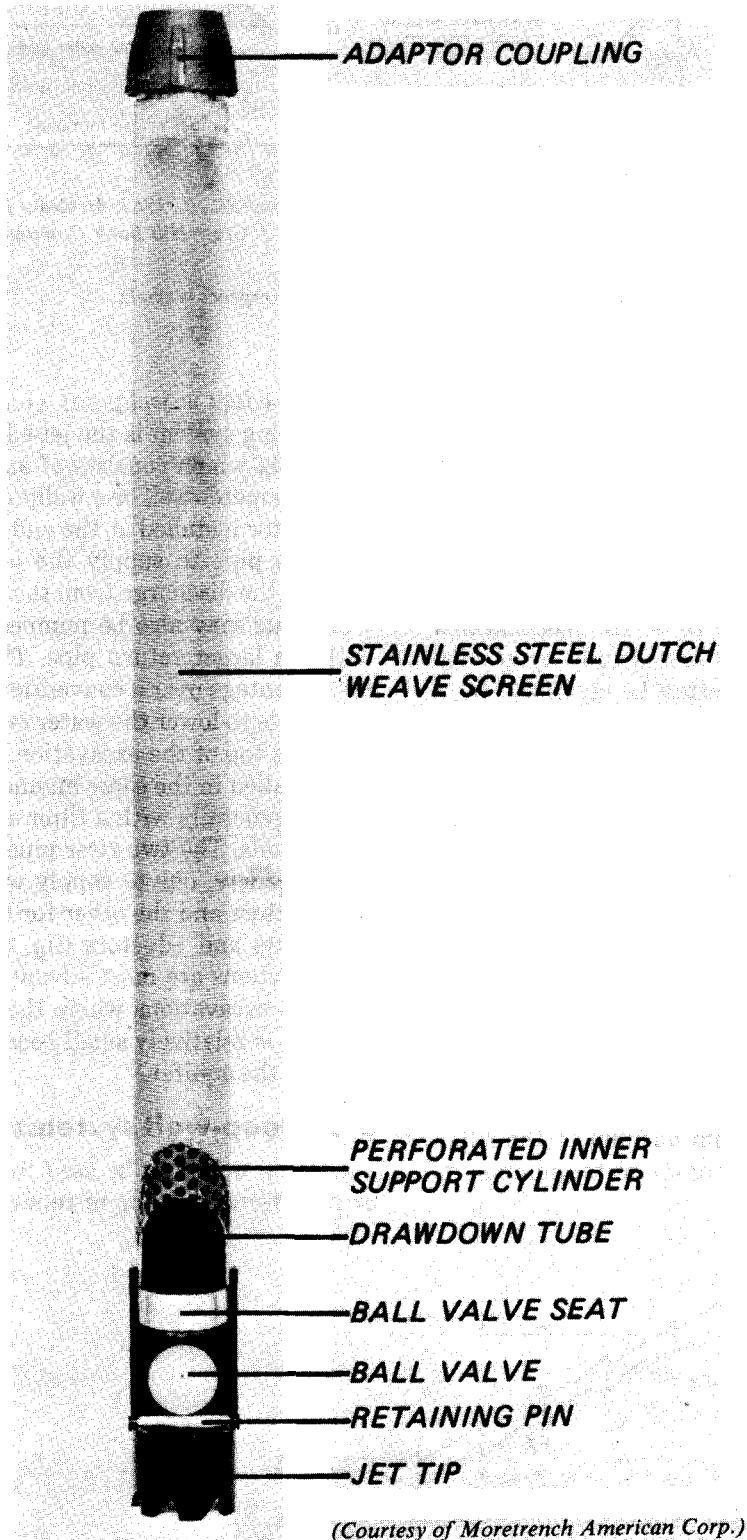
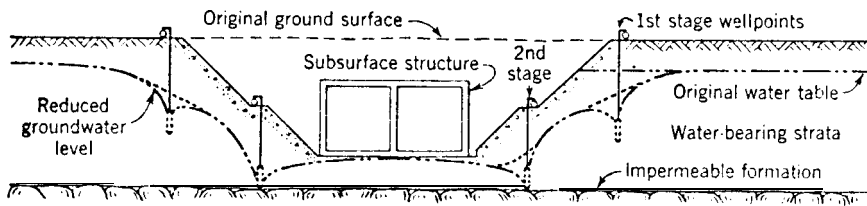

Figure 2-2. Self-jetting wellpoint.



(From "Foundation Engineering," G. A. Leonards, ed., 1962, McGraw-Hill Book Company. Used with permission of McGraw-Hill Book Company.)

Figure 2-3. Use of wellpoints where submergence is small

supplementary method of dewatering if needed. Wellpoints are more suitable than deep wells where the submergence available for the well screens is small (fig. 2-3) and close spacing is required to intercept seepage.

b. Vacuum wellpoint systems. Silts and sandy silts ($D_{10} \leq 0.05$ millimetre) with a low coefficient of permeability ($k = 0.1 \times 10^{-4}$ to 10×10^{-4} centimetres per second) cannot be drained successfully by gravity methods, but such soils can often be stabilized by a *vacuum* wellpoint system. A vacuum wellpoint system is essentially a conventional well system in which a partial vacuum is maintained in the sand filter around the wellpoint and riser pipe (fig 2-5). This vacuum will increase the hydraulic gradient producing flow to the wellpoints and will improve drainage and stabilization of the surrounding soil. For a wellpoint system, the net vacuum at the wellpoint and in the filter is the vacuum in the header pipe minus the lift or length of the riser pipe. Therefore, relatively little vacuum effect can be obtained with a wellpoint system if the lift is more than about 15 feet. If there is much air loss, it may be necessary to provide additional vacuum pumps to ensure maintaining the maximum vacuum in the filter column. The required capacity of the water pump is, of course, small,

c. Jet-eductor wellpoint systems. Another type of dewatering system is the jet-eductor wellpoint system (fig. 2-6), which consists of an eductor installed in a small diameter well or a wellpoint screen attached to a jet-eductor installed at the end of double riser pipes, a pressure pipe to supply the jet-eductor and another pipe for the discharge from the eductor pump. Eductor wellpoints may also be pumped with a pressure pipe within a larger return pipe. This type of system has the advantage over a conventional wellpoint system of being able to lower the water table as much as 100 feet from the top of the excavation. Jet-eductor wellpoints are installed in the same manner as conventional wellpoints, generally with a filter as required by the foundation soils. The two riser pipes are connected to separate headers, one to supply water under pressure to the eductors and the other for return of flow from the wellpoints and eductors (fig. 2-6). Jet-eductor wellpoint systems are most advantageously used to dewater deep excavations where the volume of water to be pumped is relatively small because of the low permeability of the aquifer.

2-5. Deep-well systems.

a. Deep wells can be used to dewater pervious sand or rock formations or to relieve artesian pressure be-

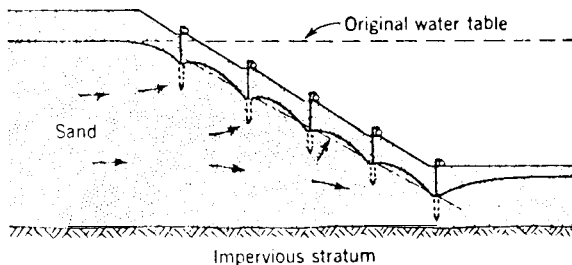

(From "Soils Mechanics in Engineering Practice," by K. Terzaghi and R. B. Peck, 1948, Wiley & Sons, Inc. Used with permission of Wiley & Sons, Inc.)

Figure 2-4. Drainage of an open deep cut by means of a multistage wellpoint system.

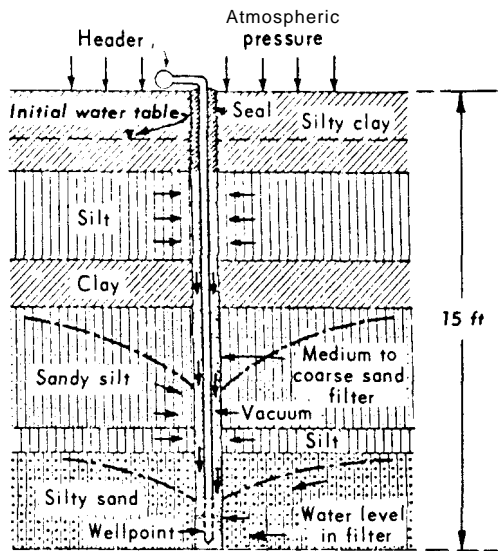

Note: Vacuum in header = 25 ft; vacuum in filter and soil in vicinity of well point = approximately 10 ft.

(From "Foundation Engineering," G. A. Leonards, ed., 1962, McGraw-Hill Book Company. Used with permission of McGraw-Hill Book Company.)

Figure 2-5. Vacuum wellpoint system,

neath an excavation. They are particularly suited for dewatering large excavations requiring high rates of pumping, and for dewatering deep excavations for dams, tunnels, locks, powerhouses, and shafts. Excavations and shafts as deep as 300 feet can be dewatered by pumping from deep wells with turbine or submersible pumps. The principal advantages of deep wells are that they can be installed around the periphery of an excavation and thus leave the construction area unencumbered by dewatering equipment, as shown in figure 2-7, and the excavation can be predrained for its full depth.

b. Deep wells for dewatering are similar in type and construction to commercial water wells. They commonly have a screen with a diameter of 6 to 24 inches with lengths up to 300 feet and are generally installed with a filter around the screen to prevent the infiltration of foundation materials into the well and to improve the yield of the well,

c. Deep wells may be used in conjunction with a vacuum system to dewater small, deep excavations for tunnels, shafts, or caissons sunk in relatively fine-grained or stratified pervious soils or rock below the groundwater table. The addition of a vacuum to the well screen and filter will increase the hydraulic gradient to the well and will create a vacuum within the surrounding soil that will prevent or minimize seepage from perched water into the excavation. Installations of this type, as shown in figure 2-8, require dequate

vacuum capacity to ensure efficient operations of the system.

2-6. Vertical sand drains. Where a stratified semipervious stratum with a low vertical permeability overlies a pervious stratum and the groundwater table has to be lowered in both strata, the water table in the upper stratum can be lowered by means of sand drains as shown in figures 2-9. If properly designed and installed, sand drains will intercept seepage in the upper stratum and conduct it into the lower, more permeable stratum being dewatered with wells or wellpoints. Sand drains consist of a column of pervious sand placed in a cased hole, either driven or drilled through the soil, with the casing subsequently removed. The capacity of sand drains can be significantly increased by installation of a slotted 1% or 2-inch pipe inside the sand drain to conduct the water down to the more pervious stratum.

2-7. Electro-osmosis. Some soils, such as silts, clayey silts, and clayey silty sands, at times cannot be dewatered by pumping from wellpoints or wells. However, such soils can be drained by wells or wellpoints combined with a flow of direct electric current through the soil toward the wells. Creation of a hydraulic gradient by pumping from the wells or wellpoints with the passage of direct electrical current through the soil causes the water contained in the soil voids to migrate from the positive electrode (anode) to the negative electrode (cathode). By making the cathode a wellpoint, the water that migrates to the cathode can be removed by either vacuum or eductor pumping (fig. 2-10).

2-8. Cutoffs. Cutoff curtains can be used to stop or minimize seepage into an excavation where the cutoff can be installed down to an impervious formation. Such cutoffs can be constructed by driving steel sheet piling, grouting existing soil with cement or chemical grout, excavating by means of a slurry trench and backfilling with a plastic mix of bentonite and soil, installing a concrete wall, possibly consisting of overlapping shafts, or freezing. However, groundwater within the area enclosed by a cutoff curtain, or leakage through or under such a curtain, will have to be pumped out with a well or wellpoint system as shown in figure 2-11.

a. *Cement and chemical grout curtains.* A cutoff around an excavation in coarse sand and gravel or porous rock can be created by injecting cement or chemical grout into the voids of the soil. For grouting to be effective, the voids in the rock or soil must be large enough to accept the grout, and the holes must be close enough together so that a continuous grout curtain is obtained. The type of grout that can be used depends upon the size of voids in the sand and gravel or rock to

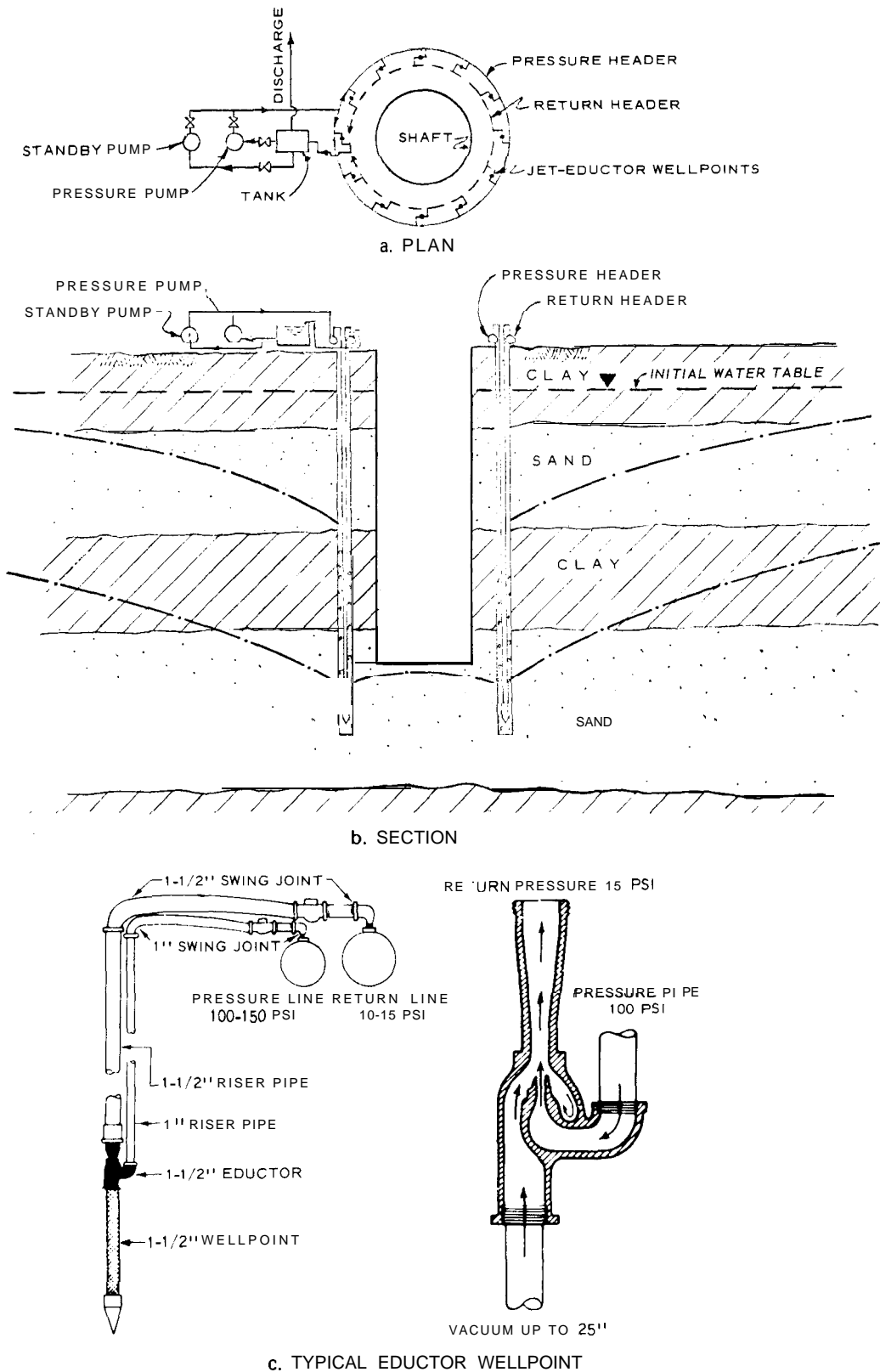

U. S Army Corps of Engineers

Figure 2-6. Jet-eductor wellpoint system for dewatering a shaft.

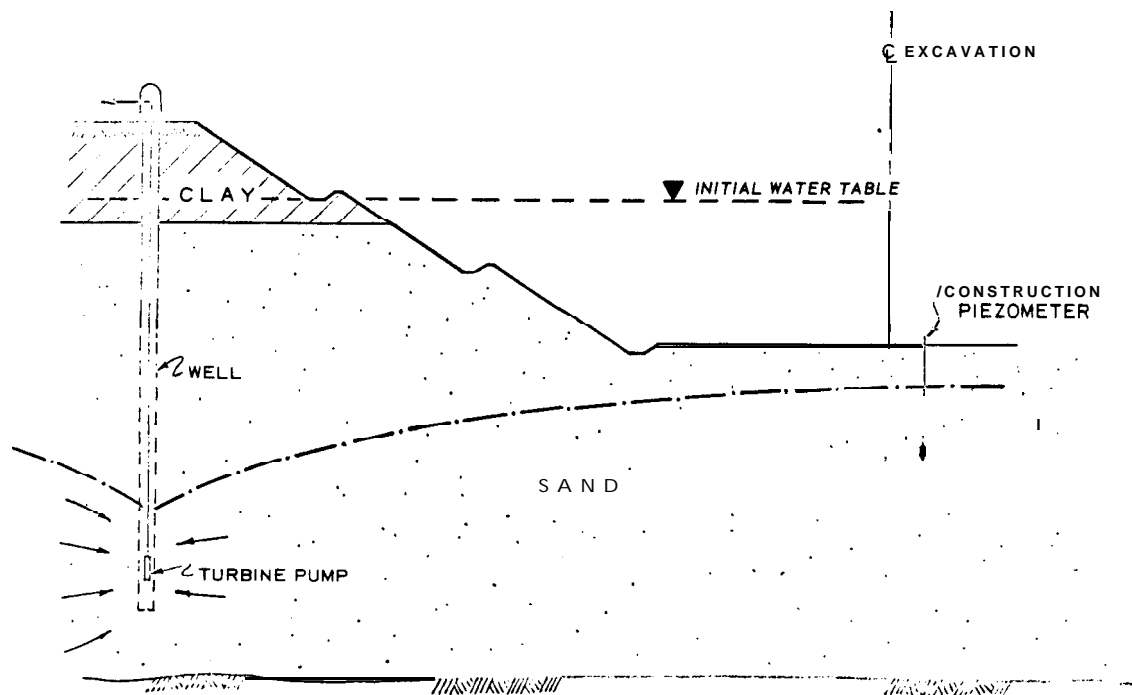

U. S. Army Corps of Engineers

Figure 2-7. Deep-well system for dewatering an excavation in sand.

be grouted. Grouts commonly used for this purpose are portland cement and water; cement, bentonite, an admixture to reduce surface tension, and water; silica gels; or a commercial product. Generally, grouting of fine or medium sand is not very effective for blocking seepage. Single lines of grout holes are also generally ineffective as seepage cutoffs; three or more lines are generally required. Detailed information on chemical grouting and grouting methods is contained in TM 5-818-6/AFM 88-32 and NAVFAC DM 7.3.

b. Slurry walls. A cutoff to prevent or minimize seepage into an excavation can also be formed by digging a narrow trench around the area to be excavated and backfilling it with an impervious soil. Such a trench can be constructed in almost any soil, either above or below the water table, by keeping the trench filled with a bentonite mud slurry and backfilling it with a suitable impervious soil. Generally, the trench is backfilled with a well-graded clayey sand gravel mixed with bentonite slurry. Details regarding design and construction of a slurry cutoff wall are given in paragraphs 4-9g(2) and 5-5b.

c. Concrete walls. Techniques have been developed for constructing concrete cutoff walls by overlapping cylinders and also as continuous walls excavated and

concreted in sections. These walls can be reinforced and are sometimes incorporated as a permanent part of a structure.

d. Steel sheet piling. The effectiveness of sheet piling driven around an excavation to reduce seepage depends upon the perviousness of the soil, the tightness of the interlocks, and the length of the seepage path. Some seepage through the interlocks should be expected. When constructing small structures in open water, it may be desirable to drive steel sheet piling around the structure, excavate the soil underwater, and then tremie in a concrete seal. The concrete tremie seal must withstand uplift pressures, or pressure relief measures must be used. In restricted areas, it may be necessary to use a combination of sheeting and bracing with wells or wellpoints installed just inside or outside of the sheeting. Sheet piling is not very effective in blocking seepage where boulders or other hard obstructions may be encountered because of driving out of interlock.

e. Freezing. Seepage into an excavation or shaft can be prevented by freezing the surrounding soil. However, freezing is expensive and requires expert design, installation, and operation. If the soil around the excavation is not completely frozen, seepage can cause rap-

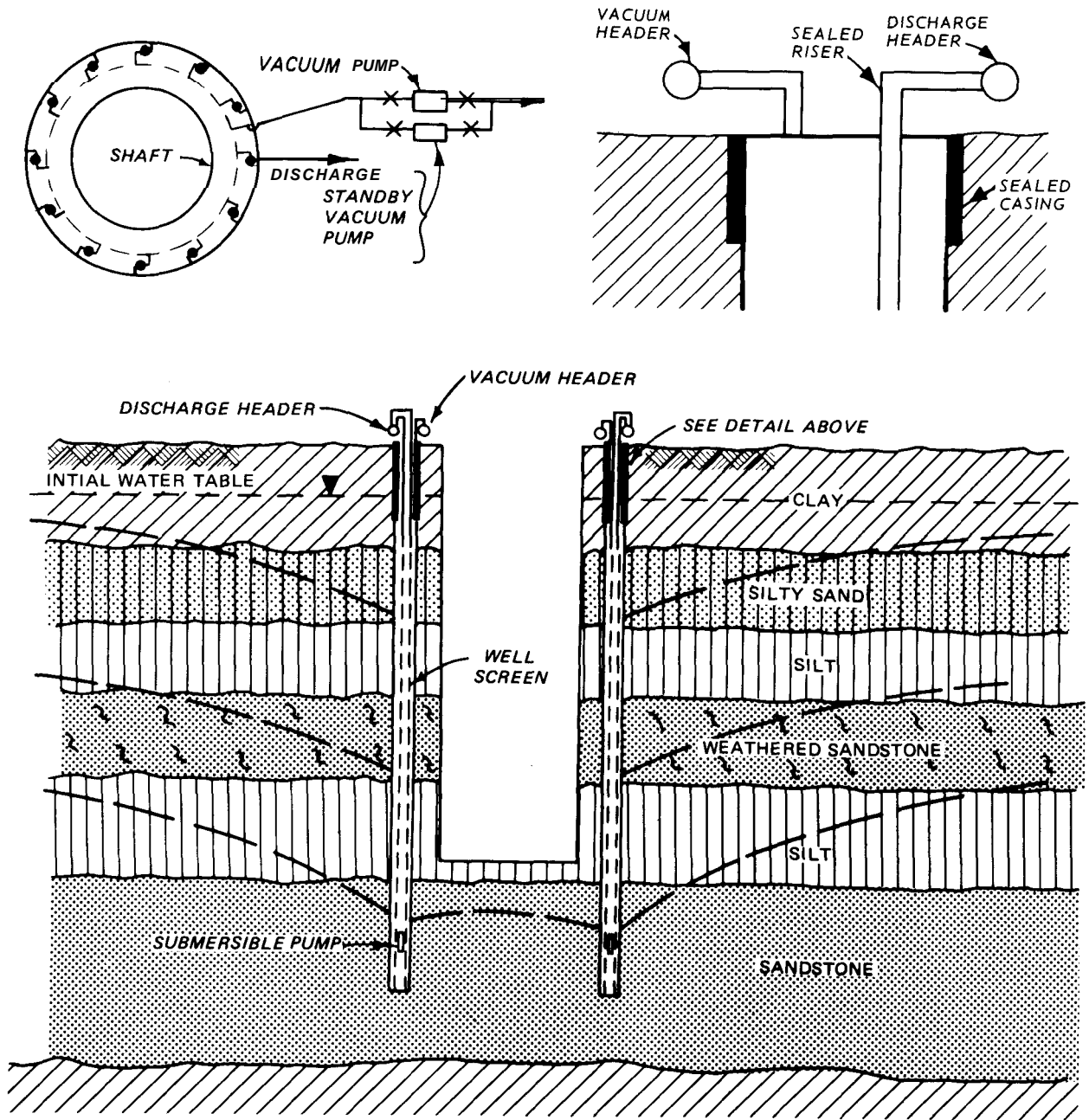

U. S. Army Corps of Engineers

Figure 2-8. Deep wells with auxiliary vacuum system for dewatering a shaft in stratified materials.

id enlargement of a fault (unfrozen zone) with consequent serious trouble, which is difficult to remedy.

2-9. Summary of groundwater control methods. A brief summary of groundwater control methods discussed in this section is given in table 2-1.

2-10. Selection of dewatering system.

a. General. The method most suitable for dewatering an excavation depends upon the location, type, size, and depth of the excavation; thickness, stratification, and permeability of the foundation soils below the water table into which the excavation extends or is

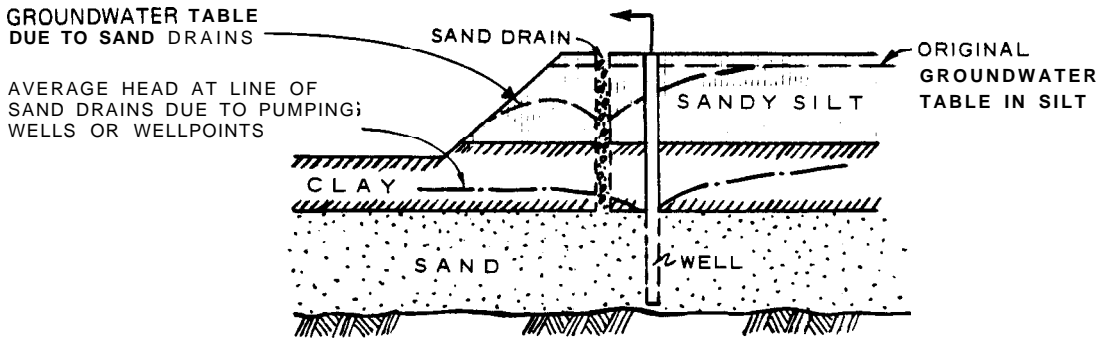

Figure 2-9. Sand drains for dewatering a slope.

underlain; potential damage resulting from failure of the dewatering system; and the cost of installation and operation of the system. The cost of a dewatering method or system will depend upon:

- (1) Type, size, and pumping requirements of project.
- (2) Type and availability of power.

(3) Labor requirements.

(4) Duration of required pumping.

The rapid development of slurry cutoff walls has made this method of groundwater control, combined with a certain amount of pumping, a practical and economical alternative for some projects, especially those where pumping costs would otherwise be great.

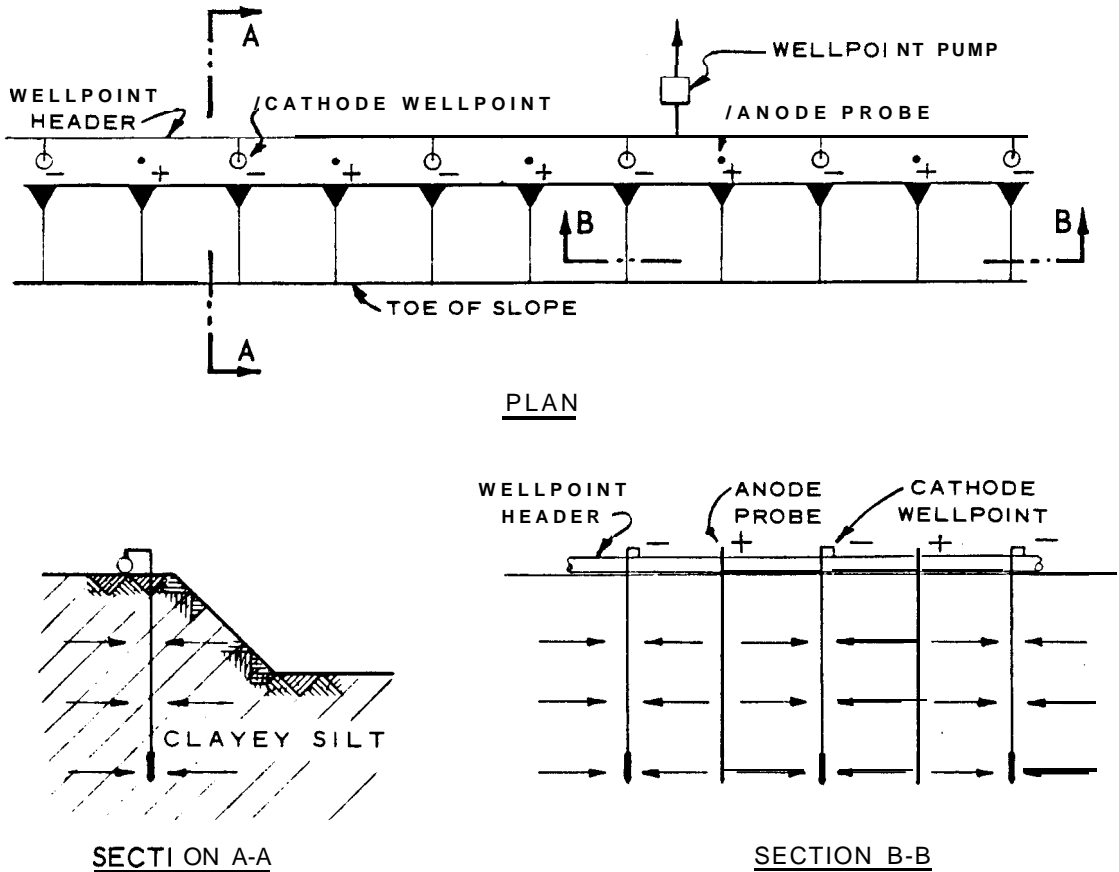

U. S. Army Corps of Engineers

Figure 2-10. Electro-osmotic wellpoint system for stabilizing an excavation slope.

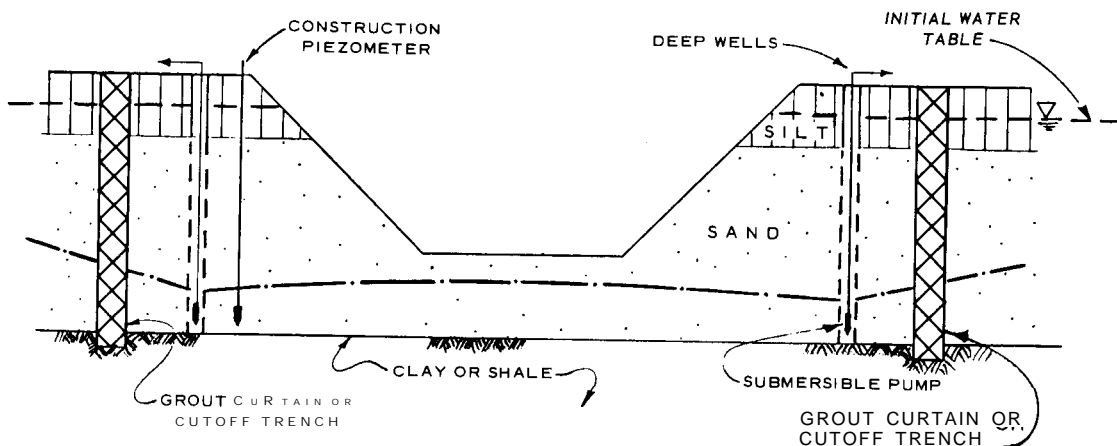

U. S. Army Corps of Engineers

Figure 2-11. Grout curtain or cutoff trench around an excavation.

b. Factors controlling selection. Where foundations must be constructed on soils below the groundwater level, it will generally be necessary to dewater the excavation by means of a deep-well or wellpoint system rather than trenching and sump pumping. Dewatering is usually essential to prevent damage to foundation soils caused by equipment operations and sloughing or sliding in of the side slopes. Conventional deep-well and wellpoint systems designed and installed by companies specializing in this work are generally satisfactory, and detailed designs need not be prepared by the engineer. However, where unusual pressure relief or dewatering requirements must be achieved, the engineer should make detailed analyses and specify the dewatering system or detailed results to be achieved in the contract documents. Where unusual equipment and procedures are required to achieve desired results, they should be described in detail in the contract documents. The user of this manual is referred to paragraphs 6b, 14b, and 2f of Appendix III, TM 5-818-4/AFM 88-5, Chapter 5, for additional discussions of dewatering requirements and contract specifications. Major factors affecting selection of dewatering and groundwater control systems are discussed in the following paragraphs.

(1) *Type of excavation.* Small open excavations, or excavations where the depth of water table lowering is small, can generally be dewatering most economically and safely by means of a conventional wellpoint system. If the excavation requires that the water table or artesian pressure be lowered more than 20 or 30 feet, a system of jet-eductor type wellpoints or deep wells may be more suitable. Either wellpoints, deep wells, or a combination thereof can be used to dewater an excavation

surrounded by a cofferdam. Excavations for deep shafts, caissons, or tunnels that penetrate stratified pervious soil or rock can generally best be dewatered with either a deep-well system (with or without an auxiliary vacuum) or a jet-eductor wellpoint system depending on the soil formation and required rate of pumping, but slurry cutoff walls and freezing should be evaluated as alternative procedures. Other factors relating to selection of a dewatering system are interference of the system with construction operations, space available for the system, sequence of construction operations, durations of dewatering, and cost of the installation and its operation. Where groundwater lowering is expensive and where cofferdams are required, caisson construction may be more economical. Caissons are being used more frequently, even for small structures.

(2) *Geologic and soil conditions.* The geologic and soil formations at a site may dictate the type of dewatering or drainage system. If the soil below the water table is a deep, more or less homogeneous, free-draining sand, it can be effectively dewatered with either a conventional well or wellpoint system. If, on the other hand, the formation is highly stratified, or the saturated soil to be dewatered is underlain by an impervious stratum of clay, shale, or rock, wellpoints or wells on relatively close centers may be required. Where soil and groundwater conditions require only the relief of artesian pressure beneath an excavation, this pressure relief can be accomplished by means of relatively few deep wells or jet-eductor wellpoints installed around and at the top of the excavation.

(a) If an aquifer is thick so that the penetration of a system of wellpoints is small, the small ratio of

Table 2-1. Summary of Groundwater Control Methods.

Method	Applicability	Remarks
Sumps and ditches	Collect water entering an excavation or structure.	Generally water level can be lowered only a few feet. Used to collect water within cofferdams and excavations. Sumping is usually only successful in relatively stable gravel or well-graded sandy gravel, partially cemented materials, or porous rock formations.
Conventional wellpoint system	Dewater soils that can be drained by gravity flow.	Most commonly used dewatering method. Drawdown limited to about 15 ft per stage; however, several stages may be used. Can be installed quickly.
Vacuum wellpoint system	Dewater or stabilize soils with low permeability. (Some silts, sandy silts).	Vacuum increases the hydraulic gradient causing flow. Little vacuum effect can be obtained if lift is more than 15 ft.
Jet-eductor wellpoint	Dewater soils that can be drained by gravity flow. Usually for deep excavations where small flows are required.	Can lower water table as much as 100 ft from top of excavation. Jet-eductors are particularly suitable for dewatering shafts and tunnels. Two header pipes and two riser pipes, or a pipe within a pipe, are required.
Deep-well systems	Dewater soils that can be drained by gravity flow. Usually for large, deep excavations where large flows are required.	Can be installed around periphery of excavation, thus removing dewatering equipment from within the excavation. Deep wells are particularly suitable for dewatering shafts and tunnels.
Vertical sand drains	Usually used to conduct water from an upper stratum to a lower more pervious stratum.	Not effective in highly pervious soils.
Electroosmosis	Dewater soils that cannot be drained by gravity. (Some silts, clayey silts, clayey silty sands),	Direct electrical current increases hydraulic gradient causing flow.
Cutoffs	Stop or minimize seepage into an excavation when installed down to an impervious stratum.	See paragraph 2-8 for materials used.

U. S. Army Corps of Engineers

screen length to aquifer thickness may result in relatively little drawdown within the excavation, even though the water table is lowered 15 to 20 feet at the line of wellpoints. For deep aquifers, a deep-well system will generally be more applicable, or the length of the wellpoints should be increased and the wellpoints set deep and surrounded with a high-capacity filter. On the other hand, if the aquifer is relatively thin or stratified wellpoints may be best suited to the situation.

(b) The perviousness and drainability of a soil or rock may dictate the general type of a dewatering system to be used for a project. A guide for the selection of a dewatering system related to the grain size of soils is presented in figure 2-12. Some gravels and rock formations may be so permeable that a barrier to flow, such as a slurry trench, grout curtain, sheet pile cutoff, or freezing, may be necessary to reduce the quantity of flow to the dewatering system to reasonable proportions. Clean, free-draining sands can be effectively dewatered by wells or wellpoints. Drainage of sandy silts and silts will usually require the application of additional vacuum to well or wellpoint dewatering systems, or possibly the use of the electroosmotic method of dewatering where soils are silty or clayey. However, where thin sand layers are present, special requirements may be unnecessary. Electroosmosis should never be used until a test of a conventional system of wellpoints, wells with vacuum, or jet-eductor wellpoints has been attempted.

(3) *Depth of groundwater lowering.* The magnitude of the drawdown required is an important consideration in selecting a dewatering system. If the drawdown required is large, deep wells or jet-eductor wellpoints may be the best because of their ability to achieve large drawdowns from the top of an excavation, whereas many stages of wellpoints would be required to accomplish the same drawdown. Deep wells can be used for a wide range of flows by selecting pumps of appropriate size, but jet-eductor wellpoints are not as flexible. Since jet-eductor pumps are relatively inefficient, they are most applicable where well flows are small as in silty to fine sand formations.

(4) *Reliability requirements.* The reliability of groundwater control required for a project will have a significant bearing on the design of the dewatering pumps, power supply, and standby power and equipment. If the dewatering problem is one involving the relief of artesian pressure to prevent a "blowup" of the bottom of an excavation, the rate of water table rebound, in event of failure of the system, may be extremely rapid. Such a situation may influence the type of pressure relief system selected and require inclusion of standby equipment with automatic power transfer and starting equipment.

(5) *Required rate of pumping.* The rate of pump-

ing required to dewater an excavation may vary from 5 to 50,000 gallons per minute or more. Thus, flow to a drainage system will have an important effect on the design and selection of the wells, pumps, and piping system. Turbine or submersible pumps for pumping deep wells are available in sizes from 3 to 14 inches with capacities ranging from 5 to 5000 gallons per minute at heads up to 500 feet. Wellpoint pumps are available in sizes from 6 to 12 inches with capacities ranging from 500 to 5000 gallons per minute depending upon vacuum and discharge heads. Jet-eductor pumps are available that will pump from 3 to 20 gallons per minute for lifts up to 100 feet. Where soil conditions dictate the use of vacuum or electroosmotic wellpoint systems, the rate of pumpage will be very small. The rate of pumpage will depend largely on the distance to the effective source of seepage, amount of drawdown or pressure relief required, and thickness and perviousness of the aquifer through which the flow is occurring.

(6) *Intermittent pumping.* Pumping labor costs can occasionally be materially reduced by pumping a dewatering system only one or two shifts per day. While this operation is not generally possible, nor advantageous, it can be economical where the dewatered area is large; subsoils below subgrade elevation are deep, pervious, and homogeneous; and the pumping plant is oversize. Where these conditions exist, the pumping system can be operated to produce an abnormally large drawdown during one or two shifts. The recovery during nonpumping shifts raises the groundwater level, but not sufficiently to approach subgrade elevation. This type of pumping plant operation should be permitted only where adequate piezometers have been installed and are read frequently.

(7) *Effect of ground water lowering on adjacent structures and wells.* Lowering the groundwater table increases the load on foundation soils below the original groundwater table. As most soils consolidate upon application of additional load, structures located within the radius of influence of a dewatering system may settle. The possibility of such settlement should be investigated before a dewatering system is designed. Establishing reference hubs on adjacent structures prior to the start of dewatering operations will permit measuring any settlement that occurs during dewatering, and provides a warning of possible distress or failure of a structure that might be affected. Recharge of the groundwater, as illustrated in figure 2-13, may be necessary to reduce or eliminate distress to adjacent structures, or it may be necessary to use positive cutoffs to avoid lowering the groundwater level outside of an excavation. Positive cutoffs include soil freezing and slurry cutoff techniques. Observations should be made of the water level in nearby wells before and during dewatering to determine any effect

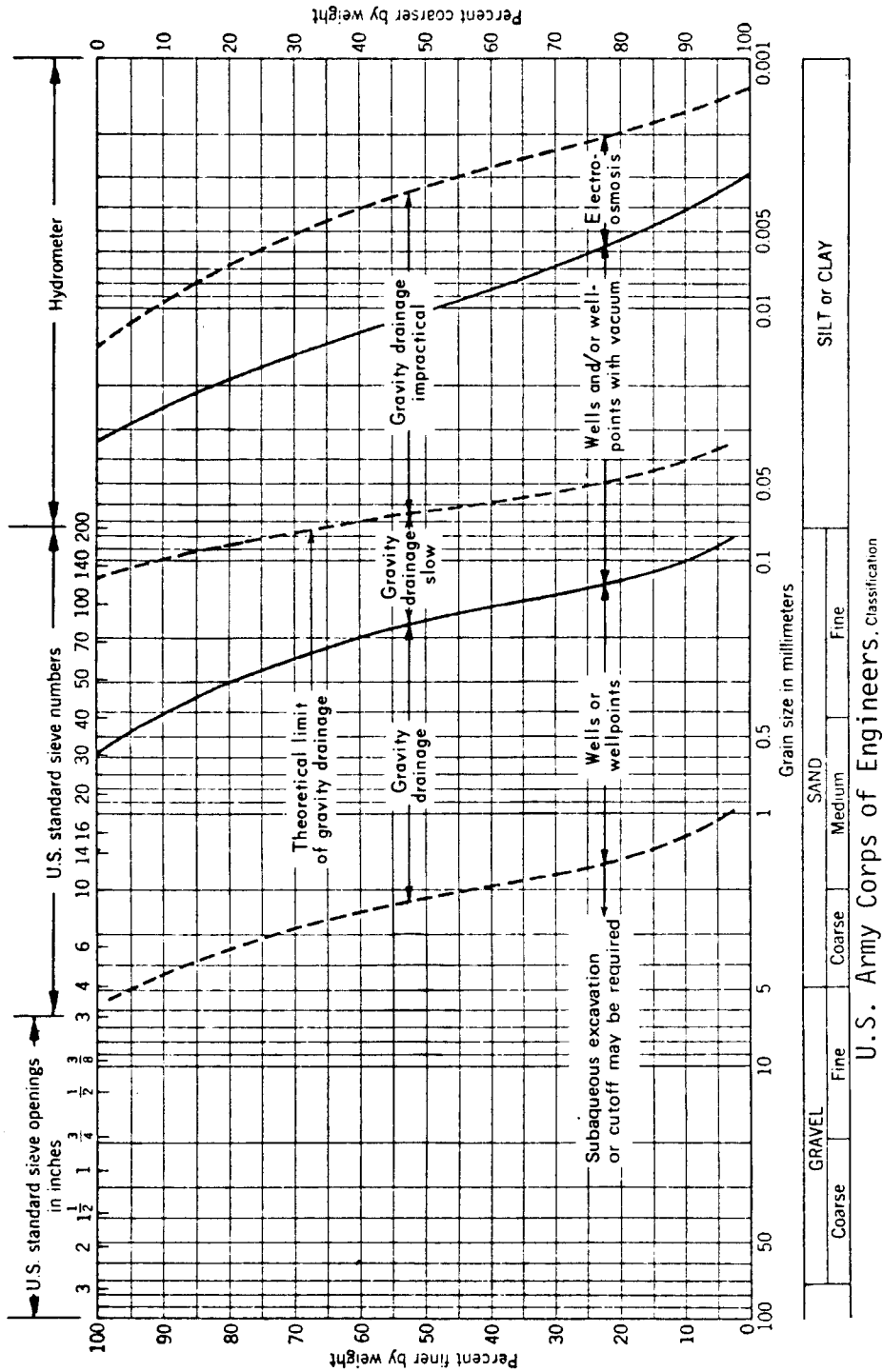

(Courtesy of Moretrench American Corp.)

Figure 2-12. Dewatering systems applicable to different soils.

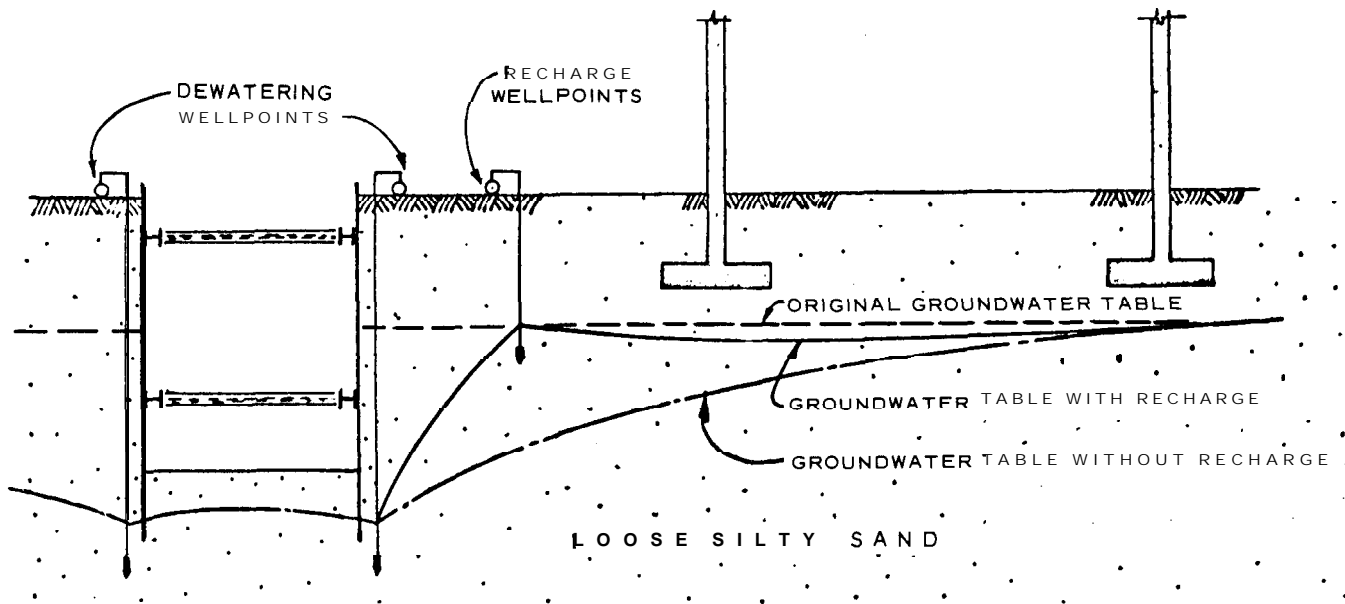

U. S. Army Corps of Engineers

Figure 2-13. Recharge of groundwater to prevent settlement of a building as a result of dewatering operations.

of dewatering. This information will provide a basis for evaluating any claims that may be made.

(8) *Dewatering versus cutoffs and other procedures.* While dewatering is generally the most expeditious and economical procedure for controlling water, it is sometimes possible to excavate more economically in the wet inside of a cofferdam or caisson and then seal the bottom of the excavation with a tremie seal, or use a combination of slurry wall or other type of cutoff and dewatering. Where subsurface construction extends to a considerable depth or where high uplift pressures or large flows are anticipated, it may occasionally be advantageous to: substitute a caisson for a conventional foundation and sink it to the

design elevation without lowering the groundwater level; use a combination of concrete cutoff walls constructed in slurry-supported trenches, and a tremied concrete foundation slab, in which case the cutoff walls may serve also as part of the completed structure; use large rotary drilling machines for excavating purposes, without lowering the groundwater level; or use freezing techniques. Cofferdams, caissons, and cutoff walls may have difficulty penetrating formations containing numerous boulders. Foundation designs requiring compressed air will rarely be needed, although compressed air may be economical or necessary for some tunnel construction work.

CHAPTER 3

GEOLOGIC, SOIL, AND GROUNDWATER INVESTIGATIONS

3-1. General. Before selecting or designing a system for dewatering an excavation, it is necessary to consider or investigate subsurface soils, groundwater conditions, power availability, and other factors as listed in table 3-1. The extent and detail of these investigations will depend on the effect groundwater and hydrostatic pressure will have on the construction of the project and the complexity of the dewatering problem.

3-2. Geologic and soil conditions. An understanding of the geology of the area is necessary to plan any investigation of subsurface soil conditions. Information obtained from the geologic and soil investigations as outlined in TM 5-818-1/AFM 88-3, Chapter 7 or NAVFAC DM7.1, should be used in evaluating a dewatering or groundwater control problem. Depending on the completeness of information available, it may be possible to postulate the general

Table 3-1. Preliminary Investigations

Item	Investigate	Reference
Geologic and soil conditions	Type, stratification, and thickness of soil involved in excavation and dewatering	Para 3-2; TM 5-818-1/AFM 88-3, Chapter 7 NAVFAC DM7.1
Criticality	Reliability of power system, damage to excavation or foundation in event of failure, rate of rebound, etc.	
Groundwater or piezometric pressure characteristics	Groundwater table or hydrostatic pressure in area and its source. Variation with river stage, season of year, etc. Type of seepage (artesian, gravity, combined). Chemical characteristics and temperature of groundwater.	Para 2-3 and 3-3
Permeability	Determine permeability from visual, field, or laboratory tests, preferably by field tests.	Para 3-4; Appendix C
Power	Availability, reliability, and capacity of power at site.	Para 3-5
Degree of possible flooding	Rainfall in area. Runoff characteristics. High-water levels in nearby bodies of water.	Para 3-6

characteristics and stratification of the soil and rock formations in the area. With this information and the size of and depth of the excavation to be dewatered, the remainder of the geologic and soil investigations can be planned. Seismic or resistivity surveys (as well as logged core and soil borings) may be useful in delineating the thickness and boundaries of major geologic and soil formations and will often show irregularities in the geologic profile that might otherwise go undetected (fig. 3-1).

a. Borings.

(1) A thorough knowledge of the extent, thickness, stratification, and seepage characteristics of the subsurface soil or rock adjacent to and beneath an excavation is required to analyze and design a dewatering system. These factors are generally determined during the normal field exploration that is required for most structures. Samples of the soil or rock formation obtained from these borings should be suitable for classifying and testing for grain size and permeability, if the complexity of the project warrants. All of the information gathered in the investigations should be presented on soil or geologic profiles of the site. For large, complex dewatering or drainage projects, it may be desirable to construct a three-dimensional model of colored pegs or transparent plastic to depict the different geologic or soil formations at the site.

(2) The depth and spacing of borings (and samples) depend on the character of the materials and on the type and configuration of the formations or deposits as discussed in TM 5-818-1/AFM 88-3, Chapter 7. Care must be taken that the borings accomplish the following:

(a) Completely penetrate and sample all aquifers that may have a bearing on dewatering an excavation and controlling artesian pressures.

(b) Identify (and sample) all soils or rocks that would affect or be affected by seepage or hydrostatic pressure.

(c) Delineate the soil stratification.

(d) Reveal any significant variation in soil and rock conditions that would have a bearing on seepage flow, location and depth of wells, or depth of cutoff. Continuous wash or auger boring samples are not considered satisfactory for dewatering exploration as the fines tend to be washed out, thereby changing the character of the soil.

b. Rock coring. Rock samples, to be meaningful for groundwater studies, should be intact samples obtained by core drilling. Although identification of rocks can be made from drill cuttings, the determination of characteristics of rock formations, such as frequency, orientation, and width of joints or fractures, that affect groundwater flow requires core samples. The percent of core recovery and any voids or loss of drill water encountered while core drilling should be recorded. The approximate permeability of rock strata can be measured by making pressure or pumping tests of the various strata encountered. Without pressure or pumping tests, important details of a rock formation can remain undetected, even with extensive boring and sampling. For instance, open channels or joints in a rock formation can have a significant influence on the permeability of the formation, yet core samples may not clearly indicate these features where the core recovery is less than 100 percent,

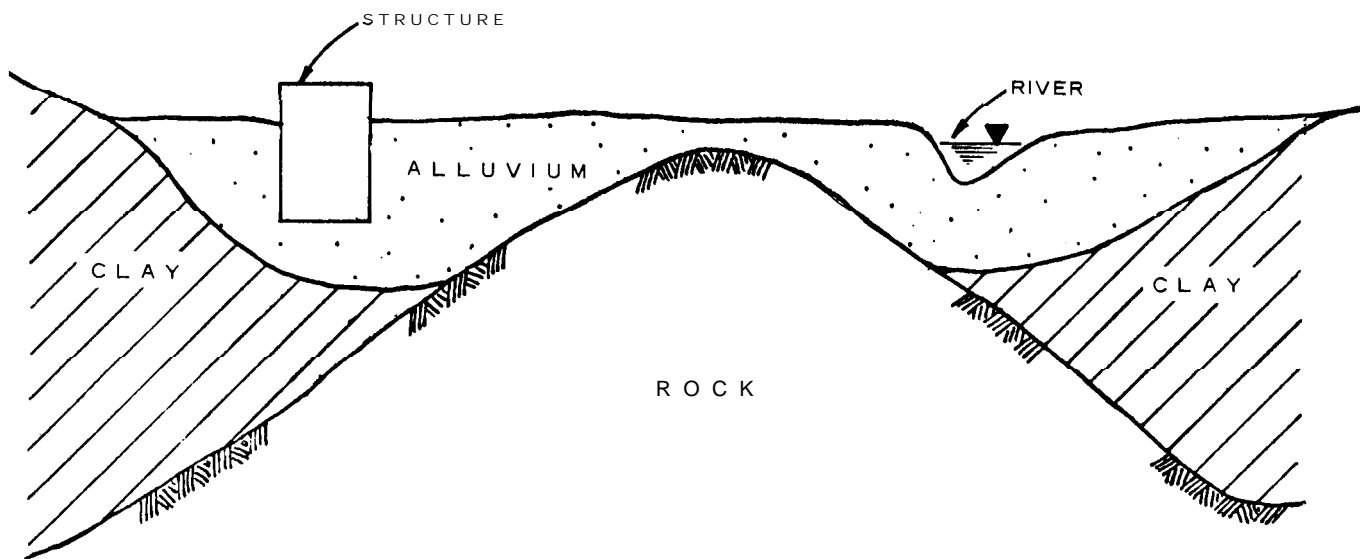

U. S. Army Corps of Engineers

Figure 3-1. Geologic profile developed from geophysical explorations.

c. Soil testing.

(1) All soil and rock samples should be carefully classified, noting particularly those characteristics that have a bearing on the perviousness and stratification of the formation. Soil samples should be classified in accordance with the Unified Soil Classification System described in MIL-STD-619B. Particular attention should be given to the existence and amount of fines (material passing the No. 200 sieve) in sand samples, as such have a pronounced effect on the permeability of the sand. Sieve analyses should be made on representative samples of the aquifer sands to determine their gradation and effective grain size D_{10} . The D_{10} size may be used to estimate the coefficient of permeability k . The gradation is required to design filters for wells, wellpoints, or permanent drainage systems to be installed in the formation. Correlations between k and D_{10} are presented in paragraph 3-4.

(2) Laboratory tests depicted in figure 3-2 can be used to determine the approximate coefficient of permeability of a soil or rock sample; however, permeabilities obtained from such tests may have little relation to field permeability even though conducted under controlled conditions. When samples of sand are distributed and repacked, the porosity and orientation of the grains are significantly changed, with resulting modification of the permeability. Also, any air trapped in the sand sample during testing will significantly reduce its permeability. Laboratory tests on

samples of sand that have been segregated or contaminated with drilling mud during sampling operations do not give reliable results. In addition, the permeability of remolded samples of sand is usually considerably less than the horizontal permeability k_h of a formation, which is generally the more significant k factor pertaining to seepage flow to a drainage system.

(3) Where a nonequilibrium type of pumping test (described in app C) is to be conducted, it is necessary to estimate the specific yield S_y of the formation, which is the volume of water that is free to drain out of a material under natural conditions, in percentage of total volume. It can be determined in the laboratory by:

(a) Saturating the sample and allowing it to drain. Care must be taken to assure that capillary stresses on the surface of the sample do not cause an incorrect conclusion regarding the drainage.

(b) Estimating S_y from the soil type and D_{10} size of the soil and empirical correlations based on field and laboratory tests. The specific yield can be computed from a drainage test as follows:

$$S_y = \frac{100V_y}{V} \quad (3-1)$$

where

V_y = volume of water drained from sample

V = gross volume of sample

The specific yield can be estimated from the soil type

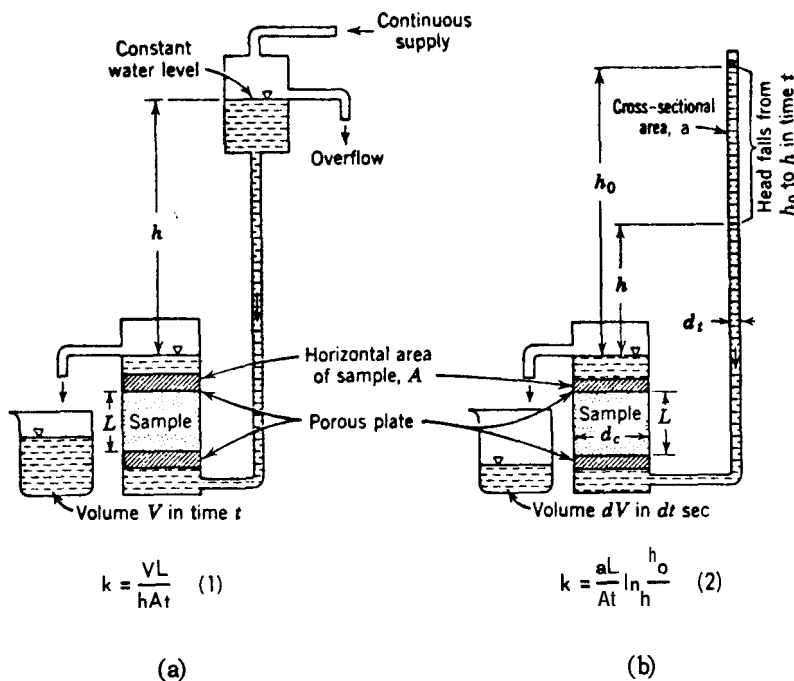

(From "Ground Water Hydrology" by D.K. Todd, 1959, Wiley & Sons, Inc. Used with permission of Wiley & Sons, Inc.)

Figure 3-2. Permeameters: (a) constant head and (b) falling head.

(or D_{10}) and the relation given in figure 3-3 or table 3-2.

3-3. Groundwater characteristics.

a. An investigation of groundwater at a site should include a study of the source of groundwater that would flow to the dewatering or drainage system (para 2-2) and determination of the elevation of the water table and its variation with changes in river or tide stages, seasonal effects, and pumping from nearby water wells. Groundwater and artesian pressure levels at a construction site are best determined from piezometers installed in the stratum that may require dewatering. Piezometers in pervious soils may be commercial wellpoints, installed with or without a filter (para 4-6c) as the gradation of foundation material requires. Piezometers in fine-grained soils with a low permeability, such as silt, generally consist of porous plastic or ceramic tips installed within a filter and attached to a relatively small diameter riser pipe.

b. The groundwater regime should be observed for an extended period of time to establish variations in level likely to occur during the construction or operation of a project, General information regarding the groundwater table and river or tide stages in the area is often available from public agencies and may serve as a basis of establishing general water levels. Specific conditions at a site can then be predicted by correlating the long-term recorded observations in the area with more detailed short-term observations at the site.

c. The chemical composition of the groundwater is of concern, because some groundwaters are highly corrosive to metal screens, pipes, and pumps, or may contain dissolved metals or carbonates that will form in-

crustations in the wells or filters and, with time, cause clogging and reduced efficiency of the dewatering or drainage system. Indicators of corrosive and incrusting waters are given in table 3-3. (Standard methods for determining the chemical compositions of groundwater are available from the American Public Health Association, Washington, DC

d. Changes in the temperature of the groundwater will result in minor variations of the quantity of water flowing to a dewatering system. The change in viscosity associated with temperature changes will result in a change in flow of about 1.5 percent for each 1° Fahrenheit of temperature change in the water. Only large variations in temperature need be considered in design because the accuracy of determining other parameters does not warrant excessive refinement.

3-4. Permeability of pervious strata. The rate at which water can be pumped from a dewatering system is directly proportional to the coefficient of permeability of the formation being dewatered; thus, this parameter should be determined reasonably accurately prior to the design of any drainage system. Methods that can be used to estimate or determine the permeability of a pervious aquifer are presented in the following paragraphs.

a. *Visual classification.* The simplest approximate method forestimating the permeability of sand is by visual examination and classification, and comparison with sands of known permeability. An approximation of the permeability of clean sands can be obtained from table 3-4.

b. *Empirical relation between D_{10} and k .* The permeability of a clean sand can be estimated from em-

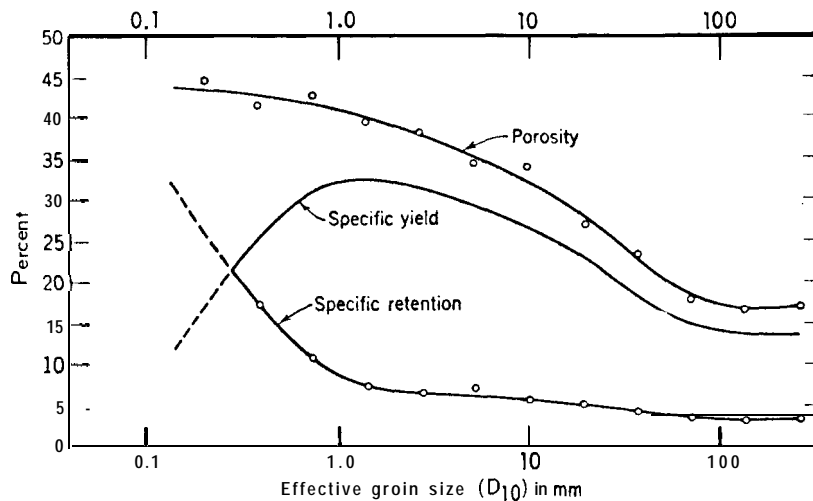

(From "Ground Water Hydrology" by D. K. Todd, 1959, Wiley & Sons, Inc. Used with permission of Wiley & Sons, Inc.)

Figure 3-3. Specific yield of water-bearing sands versus D_{10} , South Coastal Basin, California.

Table 3-2. Specific Yield of Water-Bearing Deposits in Sacramento Valley, California

Material	Specific Yield percent
Gravel	25
Sand, including sand and gravel, and gravel and sand	20
Fine sand, hard sand, tight sand, sandstone, and related deposits	10
Clay and gravel, gravel and clay, cemented gravel, and related deposits	5
Clay, silt, sandy clay, lava rock, and related fine-grained deposits	3

(From "Ground Water Hydrology by D. K. Todd, 1959, Wiley & Sons, Inc. Used with permission of Wiley & Sons, Inc.)

Table 3-3. Indicators of Corrosive and Incrusting Waters

Indicators of Corrosive Water	Indicators of Incrusting Water
1. A pH less than 7	1. A pH greater than 7
2. Dissolved oxygen in excess of 2 ppm	2. Total iron (Fe) in excess of 2 ppm
3. Hydrogen sulfide (H ₂ S) in excess of 1 ppm, detected by a rotten egg odor	3. Total manganese (Mn) in excess of 1 ppm in conjunction with a high pH and the presence of oxygen
4. Total dissolved solids in excess of 1,000 ppm indicates an ability to conduct electric current great enough to cause serious electrolytic corrosion	4. Total carbonate hardness in excess of 300 ppm
5. Carbon dioxide (CO ₂) in excess of 50 ppm	
6. Chlorides (Cl) in excess of 500 ppm	

(Courtesy of UOP Johnson Division)

Table 3-4. Approximate Coefficient of Permeability for Various Sands

Type of Sand (Unified Soil Classification System)	Coefficient of Permeability k	
	$\times 10^{-4}$ cm/sec	$\times 10^{-4}$ ft/min
Sandy silt	5-20	10-40
Silty sand	20-50	40-100
Very fine sand	50-200	100-400
Fine sand	200-500	400-1,000
Fine to medium sand	500-1,000	1,000-2,000
Medium sand	1,000-1,500	2,000-3,000
Medium to coarse sand	1,500-2,000	3,000-4,000
Coarse sand and gravel	2,000-5,000	4,000-10,000

U. S. Army Corps of Engineers

empirical relations between D_{10} and k (fig. 3-4), which were developed from laboratory and field pumping tests for sands in the Mississippi and Arkansas River valleys. An investigation of the permeability of filter sands revealed that the permeability of clean, relatively uniform, remolded sand could be estimated from the empirical relation:

$$k = C (D_{10})^2 \quad (3-2)$$

where

k = coefficient of permeability, centimetres per second

$C \cong 100$ (may vary from 40 to 150)

D_{10} = effective grain size, centimetres

Empirical relations between D_{10} and k are *only approximate* and should be *used with reservation* until a correlation based on local experience is available.

c. *Field pumping tests.* Field pumping tests are the most reliable procedure for determining the in situ permeability of a water-bearing formation. For large dewatering jobs, a pumping test on a well that fully penetrates the sand stratum to be dewatered is warranted; such tests should be made during the design phase so that results can be used for design purposes and will be available for bidders. However, for small dewatering jobs, it may be more economical to select a more conservative value of k based on empirical relations than to make a field pumping test. Pumping tests are discussed in detail in appendix C.

d. *Simple field tests in wells or piezometers.* The permeability of a water-bearing formation can be estimated from constant or falling head tests made in wells or piezometers in a manner similar to laboratory permeameter tests. Figure 3-5 presents formulas for determining the permeability using various types and installations of well screens. As these tests are sensitive to details of the installation and execution of the test, exact dimensions of the well screen, casing, and

filter surrounding the well screen, and the rate of inflow or fall in water level must be accurately measured. Disturbance of the soil adjacent to borehole or filter, leakage up the borehole around the casing, clogging or removal of the fine-grained particles of the aquifer, or the accumulation of gas bubbles in or around the well screen can make the test completely unreliable. Data from such tests must be evaluated

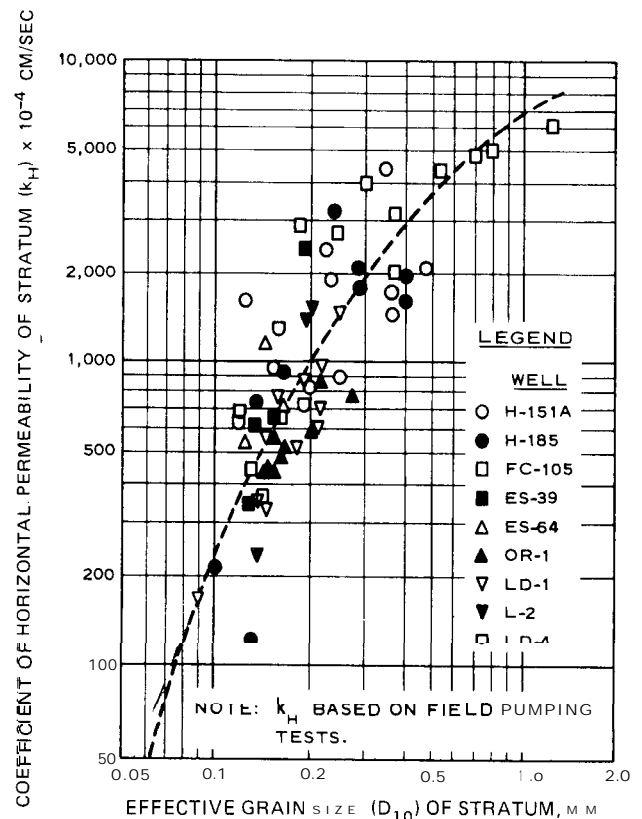
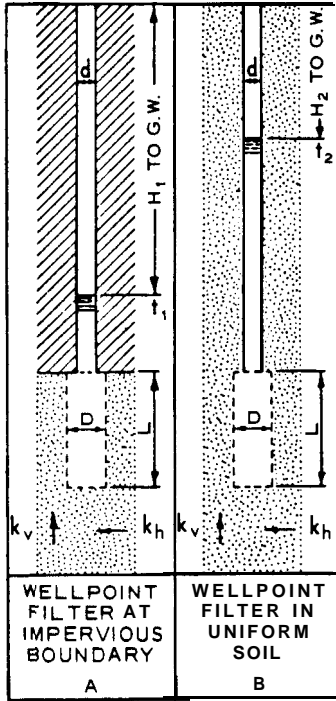

Figure 3-4. D_{10} versus in situ coefficient of horizontal permeability—Mississippi River valley and Arkansas River valley,



NOTATION	
D	= DIAM, INTAKE, SAMPLE, CM
d	= DIAM, STANDPIPE, CM
L	= LENGTH, INTAKE, SAMPLE, CM
H_c	= CONSTANT PIEZ HEAD, CM
H_1	= PIEZ HEAD FOR $t = t_1$, CM
H_2	= PIEZ HEAD FOR $t = t_2$, CM
q	= FLOW OF WATER, CM ³ /SEC
t	= TIME, SEC
k'_v	= VERT PERM CASING, CM/SEC
k_v	= VERT PERM GROUND, CM/SEC
k_h	= HORIZ PERM GROUND, CM/SEC
k_m	= MEAN COEFF PERM, CM/SEC
m	= TRANSFORMATION RATIO
$k_m = \sqrt{k_h k_v} \quad m = \sqrt{k_h/k_v}$	
$\ln = \log_e = 2.3 \log_{10}$	

CASE	CONSTANT HEAD	VARIABLE HEAD
A	$k_h = \frac{q \ln \left[\frac{2mL}{D} + \sqrt{1 + \left(\frac{2mL}{D} \right)^2} \right]}{2\pi L H_c}$	$k_h = \frac{d^2 \ln \left[\frac{2mL}{D} + \sqrt{1 + \left(\frac{2mL}{D} \right)^2} \right]}{8L (t_2 - t_1)} \ln \frac{H_1}{H_2}$ $k_h = \frac{d^2 \ln \left(\frac{4mL}{D} \right)}{8L (t_2 - t_1)} \ln \frac{H_1}{H_2} \text{ FOR } \frac{2mL}{D} > 4$
B	$k_h = \frac{q \ln \left[\frac{mL}{D} + \sqrt{1 + \left(\frac{mL}{D} \right)^2} \right]}{2\pi L H_c}$	$k_h = \frac{d^2 \ln \left[\frac{mL}{D} + \sqrt{1 + \left(\frac{mL}{D} \right)^2} \right]}{8L (t_2 - t_1)} \ln \frac{H_1}{H_2}$ $k_h = \frac{d^2 \ln \left(\frac{2mL}{D} \right)}{8L (t_2 - t_1)} \ln \frac{H_1}{H_2} \text{ FOR } \frac{mL}{D} > 4$

ASSUMPTIONS

SOIL AT INTAKE, INFINITE DEPTH AND DIRECTIONAL ISOTROPY (k_v AND k_h CONSTANT) - NO DISTURBANCE, SEGREGATION, SWELLING, OR CONSOLIDATION OF SOIL - NO SEDIMENTATION OR LEAKAGE - NO AIR OR GAS IN SOIL, WELLPOINT, OR PIPE - HYDRAULIC LOSSES IN PIPES, WELLPOINT, OR FILTER NEGLIGIBLE.

U. S. Army Corps of Engineers

Figure 3-5. Formulas for determining permeability from field falling head tests.

carefully before being used in the design of a major dewatering or drainage system.

3-5. Power. The availability, reliability, and capacity of power at a site should be investigated prior to selecting or designing the pumping units for a dewatering system. Types of power used for dewatering systems include electric, natural gas, butane, diesel, and gasoline engines. Electric motors and diesel engines are most commonly used to power dewatering equipment.

3-6. Surface water. Investigations for the control of surface water at a site should include a study of precipitation data for the locality of the project and determination of runoff conditions that will exist within the excavation. Precipitation data for various localities and the frequency of occurrence are available in publications of the U.S. Weather Bureau or other reference data. Maps showing amounts of rainfall that can be expected once every 2, 5, and 10 years in 10-, 30-, and 60-minute duration of rainfall are shown in figure 3-6. The coefficient of runoff c within the excavation will depend on the character of soils present or the treatment, if any, of the slopes. Except for excavations in clean sands, the coefficient of runoff c is generally from 0.8 to 1.0. The rate of runoff can be determined as follows:

$$Q = ciA \quad (3-3)$$

where

- Q = rate of runoff, cubic feet per second
- C = coefficient of runoff
- i = intensity of rainfall, inches per hour
- A = drainage area, acres

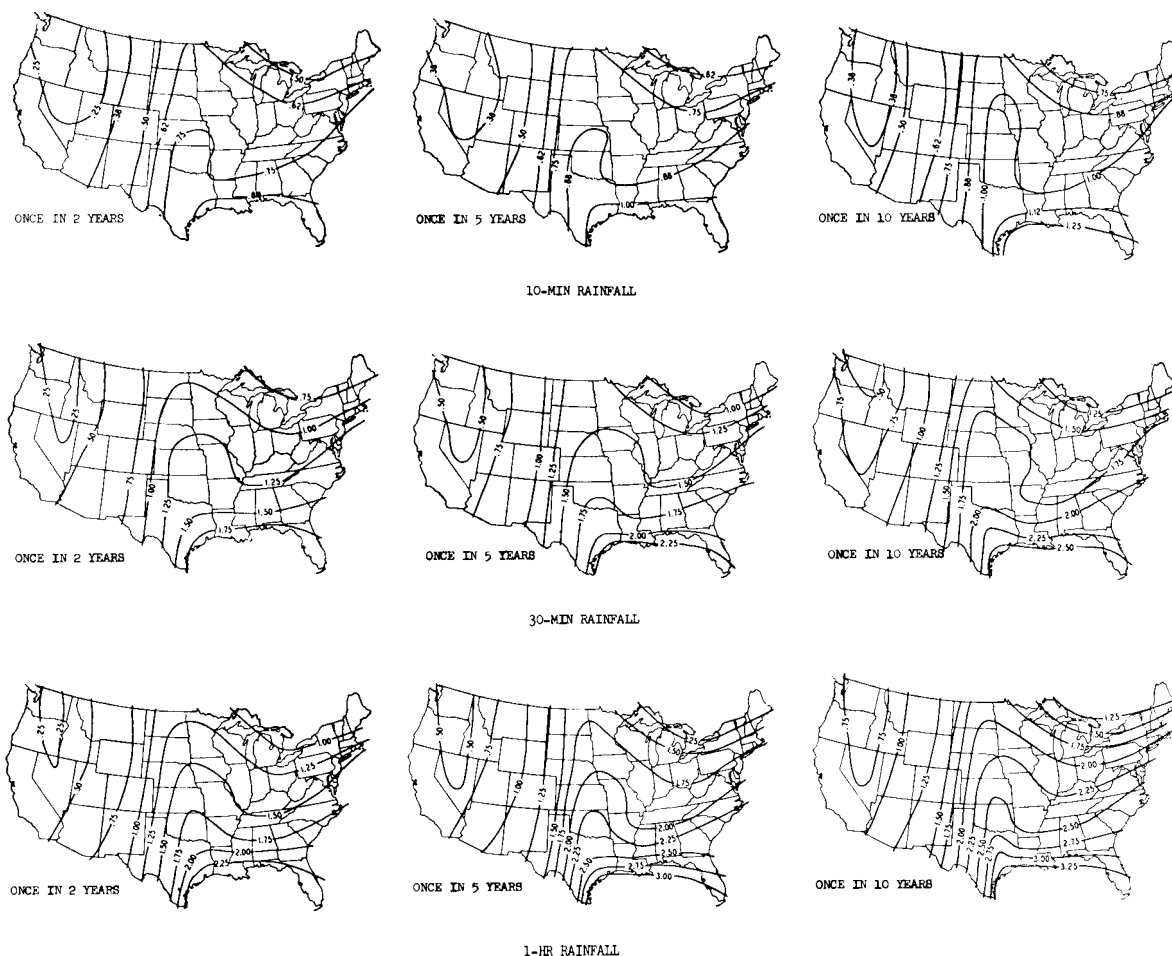

(U. S. Department of Agriculture Miscellaneous Publication No. 204)

Figure 3-6. Inches of rainfall during 10- and 30-minute and 1-hour periods.

CHAPTER 4

DESIGN OF DEWATERING, PRESSURE RELIEF, AND
GROUNDWATER CONTROL SYSTEMS

4-1. Analysis of groundwater flow.

a. Design of a dewatering and pressure relief or groundwater control system first requires determination of the type of groundwater flow (artesian, gravity, or combined) to be expected and of the type of system that will be required. Also, a complete picture of the groundwater and the subsurface condition is necessary. Then the number, size, spacing, and penetration of wellpoints or wells and the rate at which the water must be removed to achieve the required groundwater lowering or pressure relief must be determined.

b. In the analysis of any dewatering system, the source of seepage must be determined and the boundaries and seepage flow characteristics of geologic and soil formations at and adjacent to the site must be generalized into a form that can be analyzed. In some cases, the dewatering system and soil and groundwater flow conditions can be generalized into rather simple configurations. For example, the source of seepage can be reduced to a line or circle; the aquifer to a homogeneous, isotropic formation of uniform thickness; and the dewatering system to one or two parallel lines or circle of wells or wellpoints. Analysis of these conditions can generally be made by means of mathematical formulas for flow of groundwater. Complicated configurations of wells, sources of seepage, and soil formations can, in most cases, be solved or at least approximated by means of flow nets, electrical analogy models, mathematical formulas, numerical techniques, or a combination of these methods.

c. Any analysis, either mathematical, flow net, or electrical analogy, is not better than the validity of the formation boundaries and characteristics used in the analysis. The solution obtained, regardless of the rigor or precision of the analysis, will be representative of actual behavior only if the problem situation and boundary conditions are adequately represented. An approximate solution to the right problem is far more desirable than a precise solution to the wrong problem. The importance of formulating correct groundwater flow and boundary conditions, as presented in chapter 3, cannot be emphasized too strongly.

d. Methods for dewatering and pressure relief and their suitability for various types of excavations and soil conditions were described in chapter 2. The investigation of factors relating to groundwater flow and to

design of dewatering systems has been discussed in chapter 3. Mathematical, graphical, and **electroanalogous** methods of analyzing seepage flow through generalized soil conditions and boundaries to various types of dewatering or pressure relief systems are presented in paragraphs 4-2, 4-3, and 4-4.

e. Other factors that have a bearing on the actual design of dewatering, permanent drainage, and surface-water control systems are considered in this chapter.

f. The formulas and flow net procedures presented in paragraphs 4-2, 4-3, and 4-4 and figures 4-1 through 4-23 are for a steady state of groundwater flow. During initial stages of dewatering an excavation, water is removed from storage and the rate of flow is larger than required to maintain the specified drawdown. Therefore, initial pumping rates will probably be about 30 percent larger than computed values.

g. Examples of design for dewatering and pressure relief systems are given in appendix D.

4-2. Mathematical and model analyses.

a. *General.*

(1) *Design.* Design of a dewatering system requires the determination of the number, size, spacing, and penetration of wells or wellpoints and the rate at which water must be removed from the pervious strata to achieve the required groundwater lowering or pressure relief. The size and capacity of pumps and collectors also depend on the required discharge and drawdown. The fundamental relations between well and wellpoint discharge and corresponding drawdown are presented in paragraphs 4-2, 4-3, and 4-4. The equations presented assume that the flow is laminar, the pervious stratum is homogeneous and isotropic, the water draining into the system is pumped out at a constant rate, and flow conditions have stabilized. Procedures for transferring an anisotropic aquifer, with respect to permeability, to an isotropic section are presented in appendix E.

(2) *Equations for flow and drawdown to drainage slots and wells.* The equations referenced in paragraphs 4-2, 4-3, and 4-4 are in two groups: flow and drawdown to slots (b below and fig. 4-1 through 4-9) and flow and drawdown to wells (c below and fig. 4-10 through 4-22). Equations for slots are applicable to

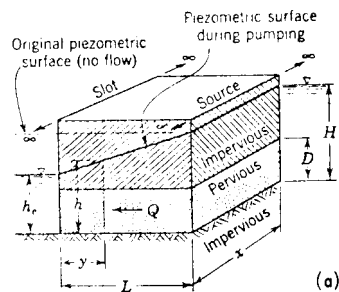

FLOW

$$Q = \frac{kDx}{L} (H - h_e) \quad (1)$$

DRAWDOWN

AT ANY DISTANCE y FROM SLOT

$$H - h = \frac{Q}{kDx} (L - y) \quad (2)$$

$$= \frac{L - y}{L} (H - h_e) \quad (2a)$$

ARTESIAN FLOW

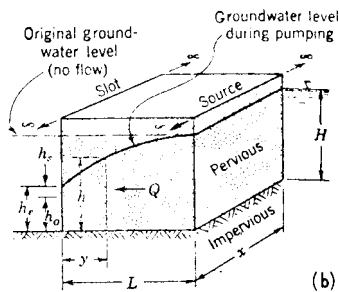

FLOW

$$Q = \frac{kx}{2L} (H^2 - h_0^2) \quad (3)$$

DRAWDOWN

AT ANY DISTANCE y FROM SLOT

$$H^2 - h^2 = \frac{L - y}{L} (H^2 - h_0^2) \quad (4)$$

WHERE $h_e = h_0 + h_s$ AND h_s IS OBTAINED FROM FIG. 4.2

GRAVITY FLOW

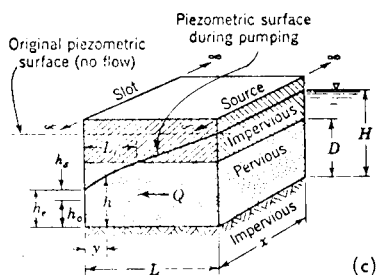

FLOW

$$Q = \frac{kx(D^2 - h_0^2)(2DH - D^2 - h_e^2)}{2L(D^2 - h_0^2)} \quad (5)$$

DRAWDOWN

AT ANY DISTANCE y FROM SLOT

FOR $y \leq L_G$ $H - h = H - \sqrt{\left[D^2 - \left(\frac{L_G - y}{L_G}\right) [D^2 - (h_0 + h_s)^2]\right]}$ (6)

FOR $y \geq L_G$ $H - h = H - \left[\left(\frac{H - D}{L - L_G}\right)(y - L_G) + D\right]$ (7)

WHERE L_G IS THE DISTANCE FROM THE SLOT TO THE POINT AT WHICH THE FLOW CHANGES FROM ARTESIAN TO GRAVITY, AND IS COMPUTED FROM

$$L_G = \frac{L[D^2 - (h_0 + h_s)^2]}{2DH - D^2 - (h_0 + h_s)^2} \quad (8)$$

COMBINED ARTESIAN-GRAVITY FLOW

(Modified from "Foundation Engineering," G.A. Leonards, ed., 1962, McGraw-Hill Book Company. Used with permission of McGraw-Hill Book Company.)

Figure 4-1. Flow and head for fully penetrating line slot; single-line source; artesian, gravity, and combined flows.

flow to trenches, French drains, and similar drainage systems. They may also be used where the drainage system consists of closely spaced wells or wellpoints. Assuming a well system equivalent to a slot usually simplifies the analysis; however, corrections must be made to consider that the drainage system consists of wells or wellpoints rather than the more efficient slot. These corrections are given with the well formulas discussed in c below. When the well system cannot be simulated with a slot, well equations must be used. The figures in which equations for flow to slots and wells appear are indexed in table 4-1. The equations

for slots and wells do not consider the effects of hydraulic head losses H_w in wells or wellpoints; procedures for accounting for these effects are presented separately.

(3) **Radius of influence R.** Equations for flow to drainage systems from a circular seepage source are based on the assumption that the system is centered on an island of radius R. Generally, R is the radius of influence that is defined as the radius of a circle beyond which pumping of a dewatering system has no significant effect on the original groundwater level or piezometric surface. The value of R can be estimated

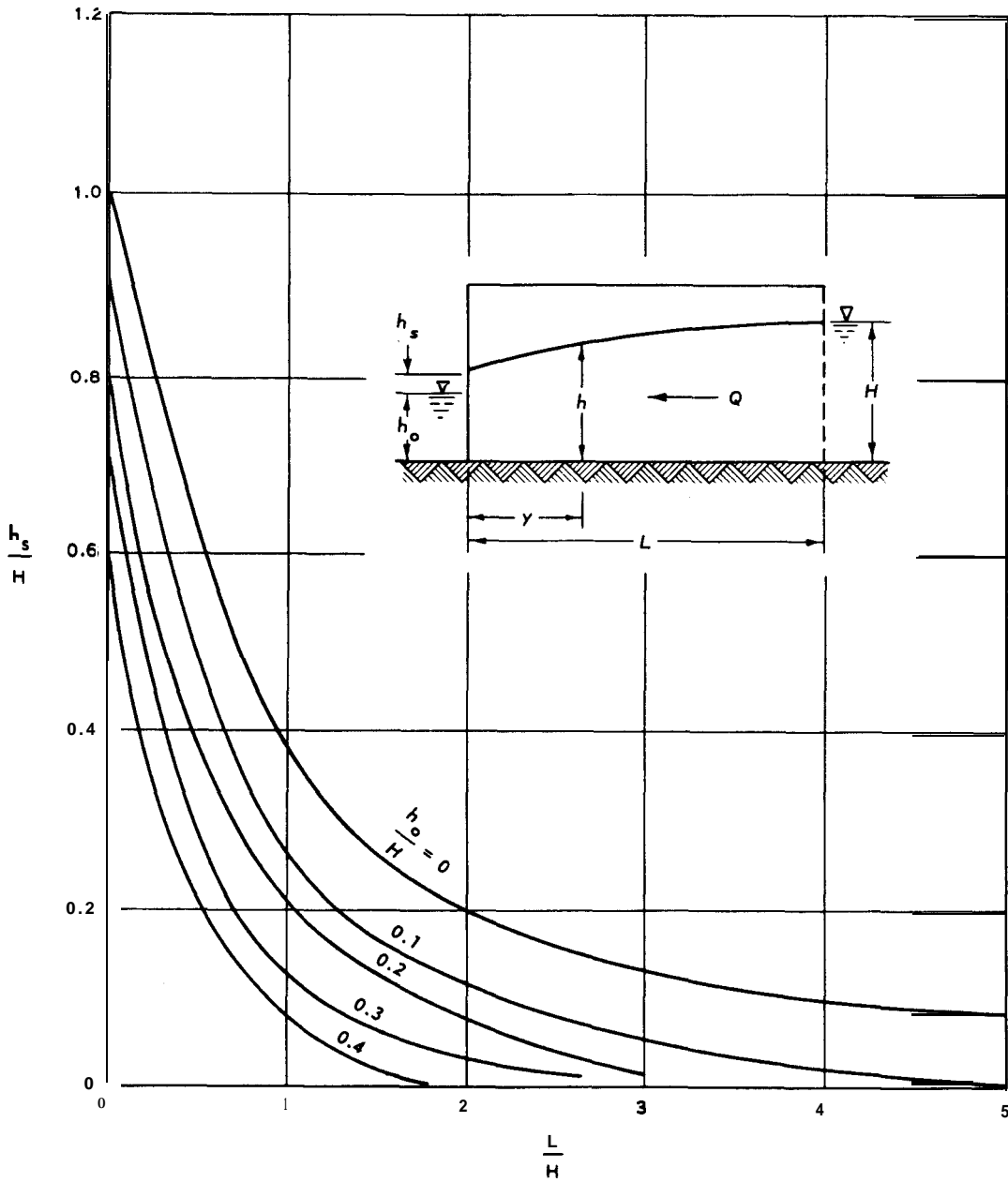

(Modified from "Foundation Engineering," G. A. Leonards, ed., 1962, McGraw-Hill Book Company. Used with permission of McGraw-Hill Book Company.)

Figure 4-2. Height of free discharge surface h_s ; gravity flow.

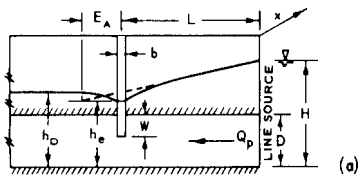

FLOW

$$Q_p = \frac{kD_v(H - h_e)}{L + E_A} \quad (1)$$

MAX RESIDUAL HEAD DOWNSTREAM OF SLOT

$$h_o = \frac{E_A(H - h_e)}{L + E_A} + h_e \quad (2)$$

WHERE E_A IS AN ADDITIONAL LENGTH FACTOR OBTAINED FROM THE FIGURE BELOW

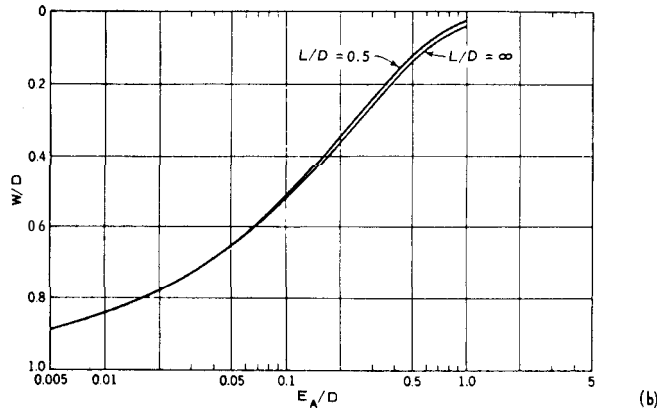

ARTESIAN FLOW

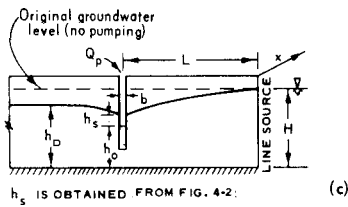

FLOW

$$Q_p = \left(0.73 + 0.27 \frac{H - h_o}{H} \right) \frac{kx}{2L} (H^2 - h_o^2) \quad (3)$$

MAX RESIDUAL HEAD DOWNSTREAM OF SLOT

$$h_o = h_o \left[\frac{1.48}{L} (H - h_o) + 1 \right] \quad (4)$$

WHERE $L \geq 3H$

GRAVITY FLOW

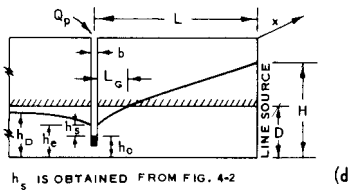

FLOW

$$Q_p = \frac{kDx(H - D)}{L - L_g} \quad (5)$$

MAX RESIDUAL HEAD DOWNSTREAM OF SLOT+

$$h_o = h_o \left[\frac{1.48}{L_g} (D - h_o) + 1 \right] \quad (6)$$

PROVIDED $h_o \leq D; L_g \geq 3D$

WHERE $L_g = \frac{L(D^2 - h_o^2) \left(0.73 + 0.27 \frac{D - h_o}{D} \right)}{2D(H - D) + (D^2 - h_o^2) \left(0.73 + 0.27 \frac{D - h_o}{D} \right)} \quad (7)$

COMBINED ARTESIAN AND GRAVITY FLOWS

(Modified from "Foundation Engineering," G. A. Leonards, ed., 1962, McGraw-Hill Book Company. Used with permission of McGraw-Hill Book Company.)

Figure 4-3. Flow and head for partially penetrating line slot; single-line source; artesian, gravity, and combined flows.

FULLY PENETRATING SLOT

THE FLOW TO A FULLY PENETRATING SLOT FROM TWO LINE SOURCES, BOTH OF INFINITE LENGTH (AND PARALLEL), IS THE SUM OF THE FLOW FROM EACH SOURCE, WITH REGARD TO THE APPROPRIATE FLOW BOUNDARY CONDITIONS, AS DETERMINED FROM THE FLOW EQUATIONS IN FIG. 4-1. LIKEWISE, THE DRAWDOWN FROM EACH SOURCE CAN BE COMPUTED FROM THE DRAWDOWN EQUATIONS IN FIG. 4-1 AS IF ONLY ONE SOURCE EXISTED.

PARTIALLY PENETRATING SLOT

ARTESIAN FLOW

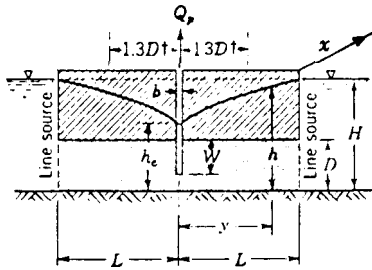

NOTE: WIDTH OF SLOT, b , ASSUMED $\neq 0$.
 † WITHIN THIS DISTANCE ($1.3D$) THE PIEZOMETRIC SURFACE IS NONLINEAR DUE TO CONVERGING FLOW.

(a)

FLOW

$$Q_p = \frac{2kDx(H - h_e)}{L + \lambda D} \quad (1)$$

‡ DRAWDOWN WHEN $y < 1.3D$ CAN BE ESTIMATED BY DRAWING A FREEHAND CURVE FROM h_e TANGENT TO THE SLOPE OF THE LINEAR PART AT $y = 1.3D$.

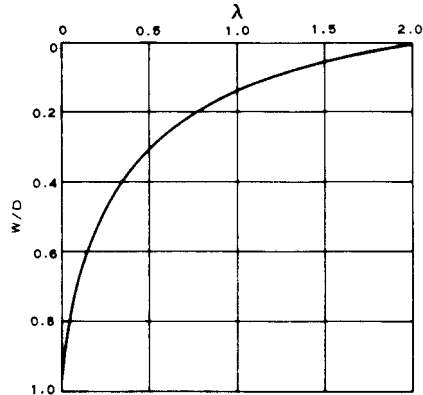

(b)

DRAWDOWN

AT ANY DISTANCE $y > 1.3D$ FROM SLOT. †

$$H - h = H - \left[h_e + (H - h_e) \frac{y + \lambda D}{L + \lambda D} \right] \quad (2)$$

GRAVITY FLOW

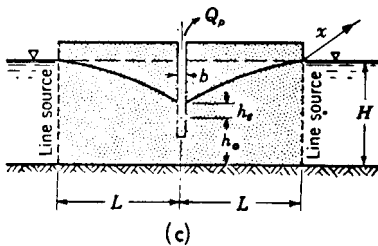

(c)

FLOW

APPROXIMATELY, BUT SOMEWHAT LESS THAN, TWICE THAT COMPUTED FROM A SINGLE SOURCE, EQ 3, FIG. 4-3.

DRAWDOWN

APPROXIMATELY THAT COMPUTED FROM A SINGLE SOURCE, EQ 4, FIG. 4-1.

(Modified from "Foundation Engineering," G. A. Leonards, ed., 1962, McGraw-Hill Book Company. Used with permission of McGraw-Hill Book Company.)

Figure 4-4. Flow and head for fully and partially penetrating line slot; two-line source; artesian and gravity flows.

A FREQUENTLY ENCOUNTERED DEWATERING SYSTEM IS ONE WITH TWO LINES OF PARTIALLY PENETRATING WELLPOINTS ALONG EACH SIDE OF A LONG EXCAVATION, WHERE THE FLOW CAN BE ASSUMED TO ORIGINATE FROM TWO EQUIDISTANT LINE SOURCES.

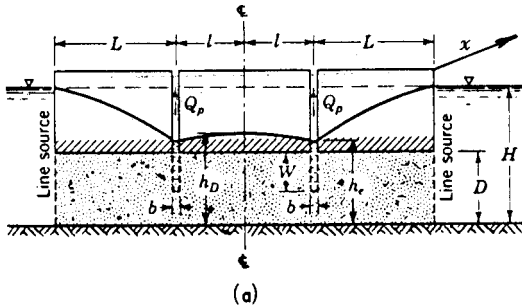

FLOW

FLOW FOR EACH SLOT CAN BE ESTIMATED AS FOR ONE SLOT WITH ONE LINE SOURCE, EQ 1, FIG. 4-3.

$$h_D \uparrow$$

VALUE OF h_D CAN BE ESTIMATED AS FOR ONE SLOT AND ONE LINE SOURCE, EQ 2, FIG. 4-3.

ARTESIAN FLOW

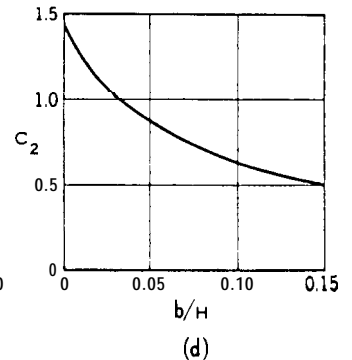
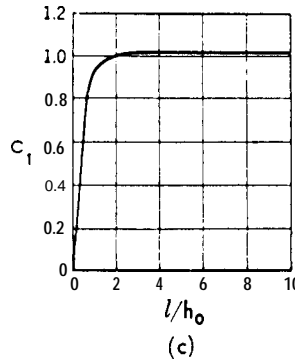
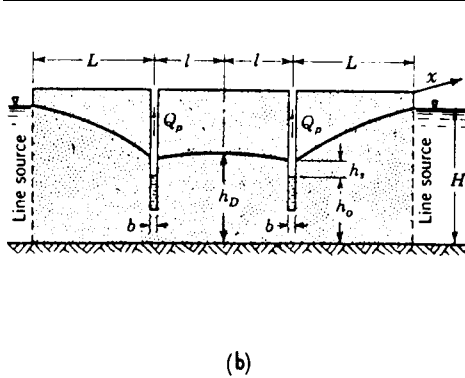

FLOW

FLOW TO EACH SLOT APPROXIMATELY THAT ONE SLOT WITH ONE LINE SOURCE, EQ 3, FIG. 4-3.

$$h_D \uparrow$$

$$h_D = h_0 \left[\frac{C_1 C_2}{L} (H - h_0) t_1 \right] \quad (1)$$

WHERE C_1 AND C_2 ARE OBTAINED FROM FIG.(c) AND (d) ABOVE.

GRAVITY FLOW

t MAXIMUM RESIDUAL HEAD MIDWAY BETWEEN THE TWO SLOTS

(Modified from "Foundation Engineering," G. A. Leonards, ed., 1962, McGraw-Hill Book Company. Used with permission of McGraw-Hill Book Company.)

Figure 4-5. Flow and head (midway) for two partially penetrating slots; two-line source; artesian and gravity flows,

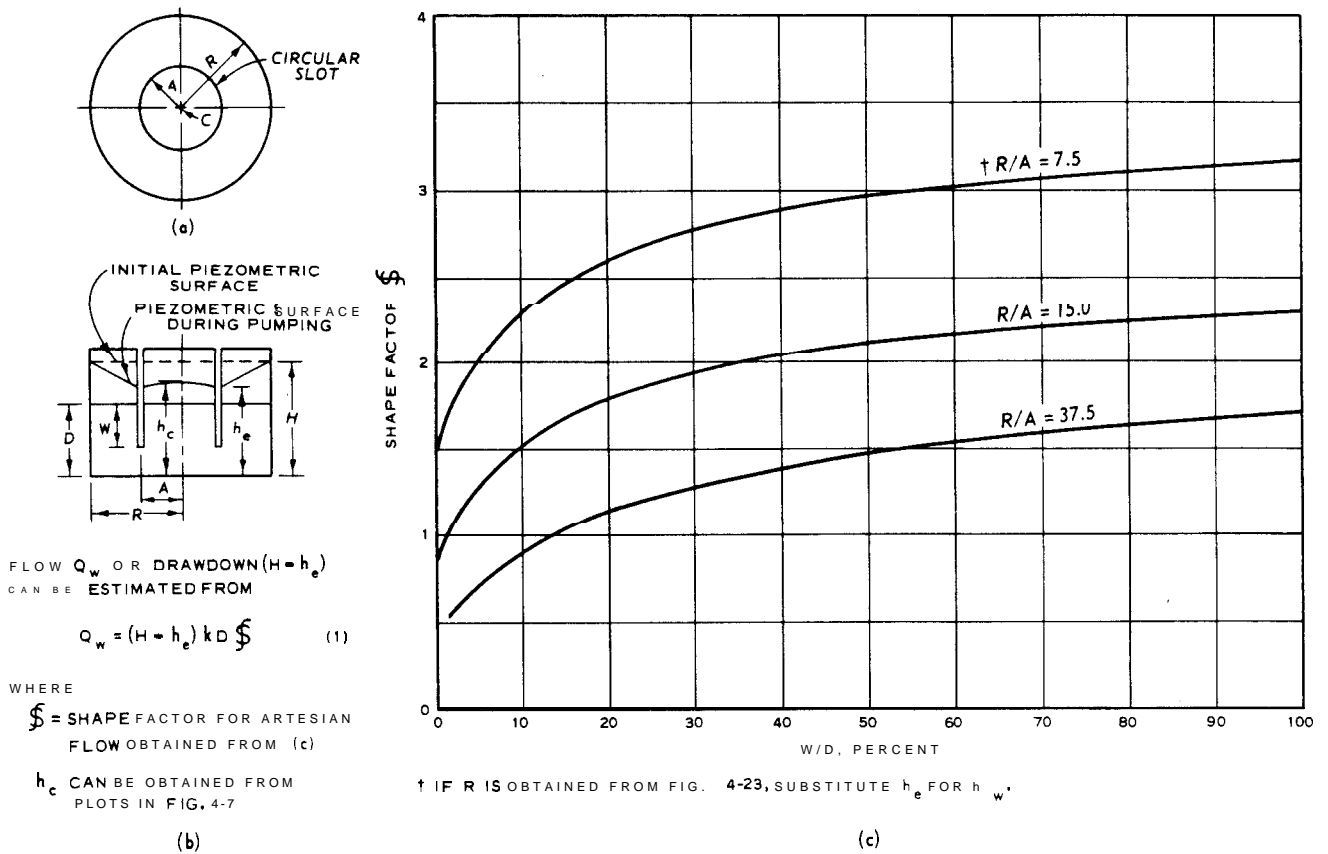

U. S. Army Corps of Engineers

Figure 4-6. Flow and head for fully and partially penetrating circular slots; circular source; artesian flow

from the equation and plots in figure 4-23. Where there is little or no recharge to an aquifer, the radius of influence will become greater with pumping time and with increased drawdown in the area being clewatered. Generally, R is greater for coarse, very pervious sands than for finer soils. If the value of R is large relative to the size of the excavation, a reasonably good approximation of R will serve adequately for design because flow and drawdown for such a condition are not especially sensitive to the actual value of R . As it is usually impossible to determine R accurately, the value should

be selected conservatively from pumping test data or, if necessary, from figure 4-23.

(4) **Wetted screen.** There should always be sufficient well and screen length below the required drawdown in a well in the formation being clewatered so that the design or required pumping rate does not produce a gradient at the interface of the formation and the well filter (or screen) or at the screen and filter that starts to cause the flow to become turbulent. Therefore, the design of a clewatering system should always be checked to see that the well or wellpoints have ade-

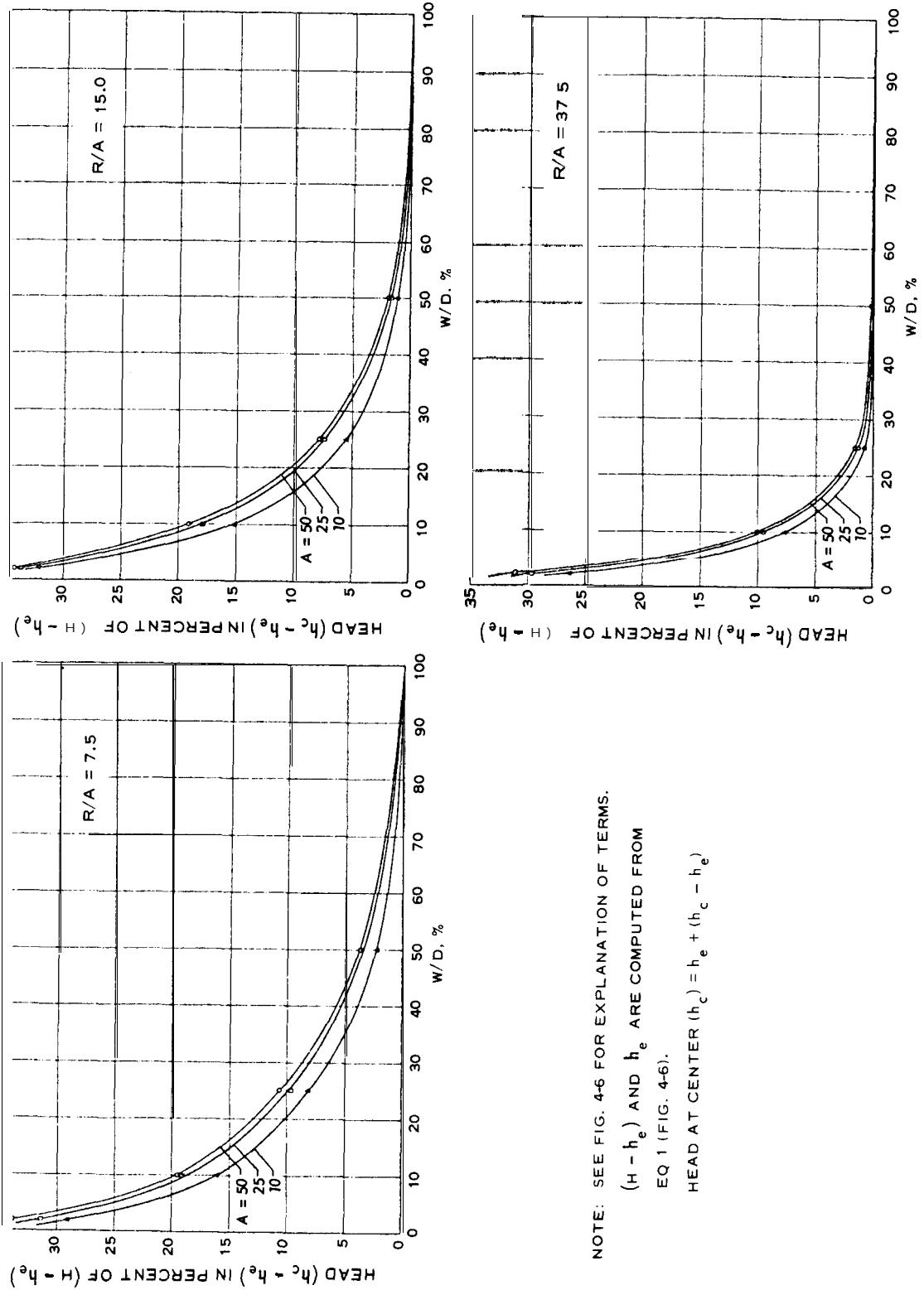

NOTE: SEE FIG. 4-6 FOR EXPLANATION OF TERMS.

($H - h_e$) AND h_e ARE COMPUTED FROM

EQ 1 (FIG. 4-6).

HEAD AT CENTER (h_c) = $h_e + (h_c - h_e)$

U. S. Army Corps of Engineers

Figure 4-7. Head at center of fully and partially penetrating circular slots; circular source; artesian flow.

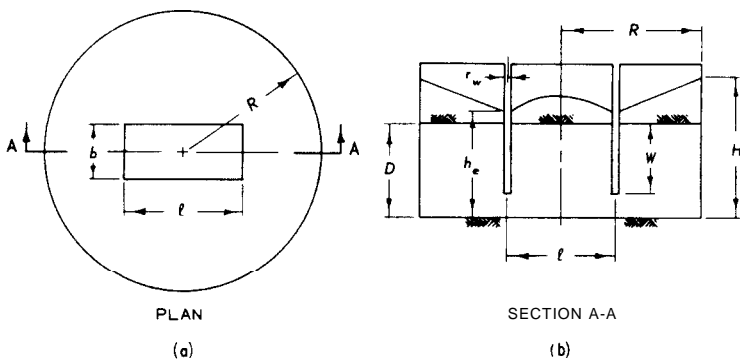

FLOW, Q_T , OR DRAWDOWN, $H-h_e$, CAN BE ESTIMATED FROM

$$Q_T = (H - h_e)kD \mathcal{S} \quad (1)$$

WHERE \mathcal{S} IS OBTAINED FROM PLOTS SHOWN BELOW AND PERCENT PENETRATION = $WD \times 100$

NOTE HEAD ALONG LINE A-A WITHIN THE ARRAY, h_p , IS OBTAINED FROM FIG 4-9

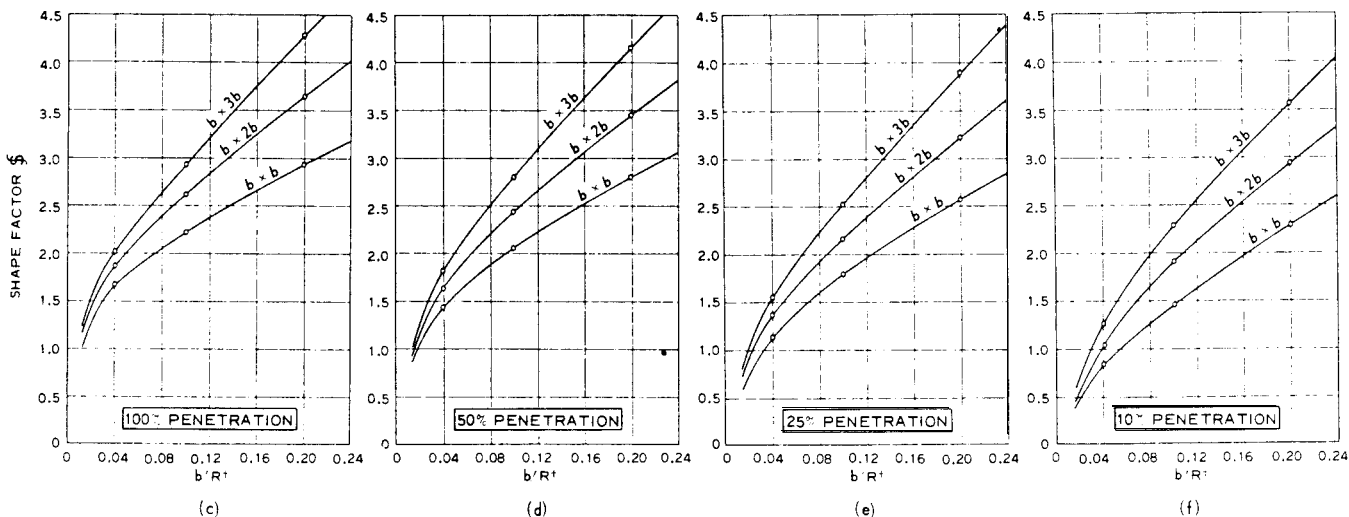

R IS OBTAINED FROM FIG. 4-23.

U. S. Army Corps of Engineers

Figure 4-8. Flow and drawdown at slot for fully and partially penetrating rectangular slots; circular source; artesian flow.

quate “wetted screen length h_{ws} ” or submergence to pass the maximum computed flow. The limiting flow q_c into a filter or well screen is approximately equal to

$$q_c = \frac{2\pi r_w \sqrt{k}}{1.07} \times \begin{matrix} 7.48 \text{ gallons per minute} \\ \text{per foot of filter} \\ \text{or screen} \end{matrix} \quad (4-1)$$

where

- r_w = radius of filter or screen
- k = coefficient of permeability of filter or aquifer sand, feet per minute

(5) Hydraulic head loss H_w . The equations in fig-

ures 4-1 through 4-22 do not consider hydraulic head losses that occur in the filter, screen, collector pipes, etc. These losses cannot be neglected, however, and must be accounted for separately. The hydraulic head loss through a filter and screen will depend upon the diameter of the screen, slot width, and opening per foot of screen, permeability and thickness of the filter; any clogging of the filter or screen by incrustation, drilling fluid, or bacteria; migration of soil or sand particles into the filter; and rate of flow per foot of screen. Graphs for estimating hydraulic head losses in pipes, wells, and screens are shown in figures 4-24 and 4-25.

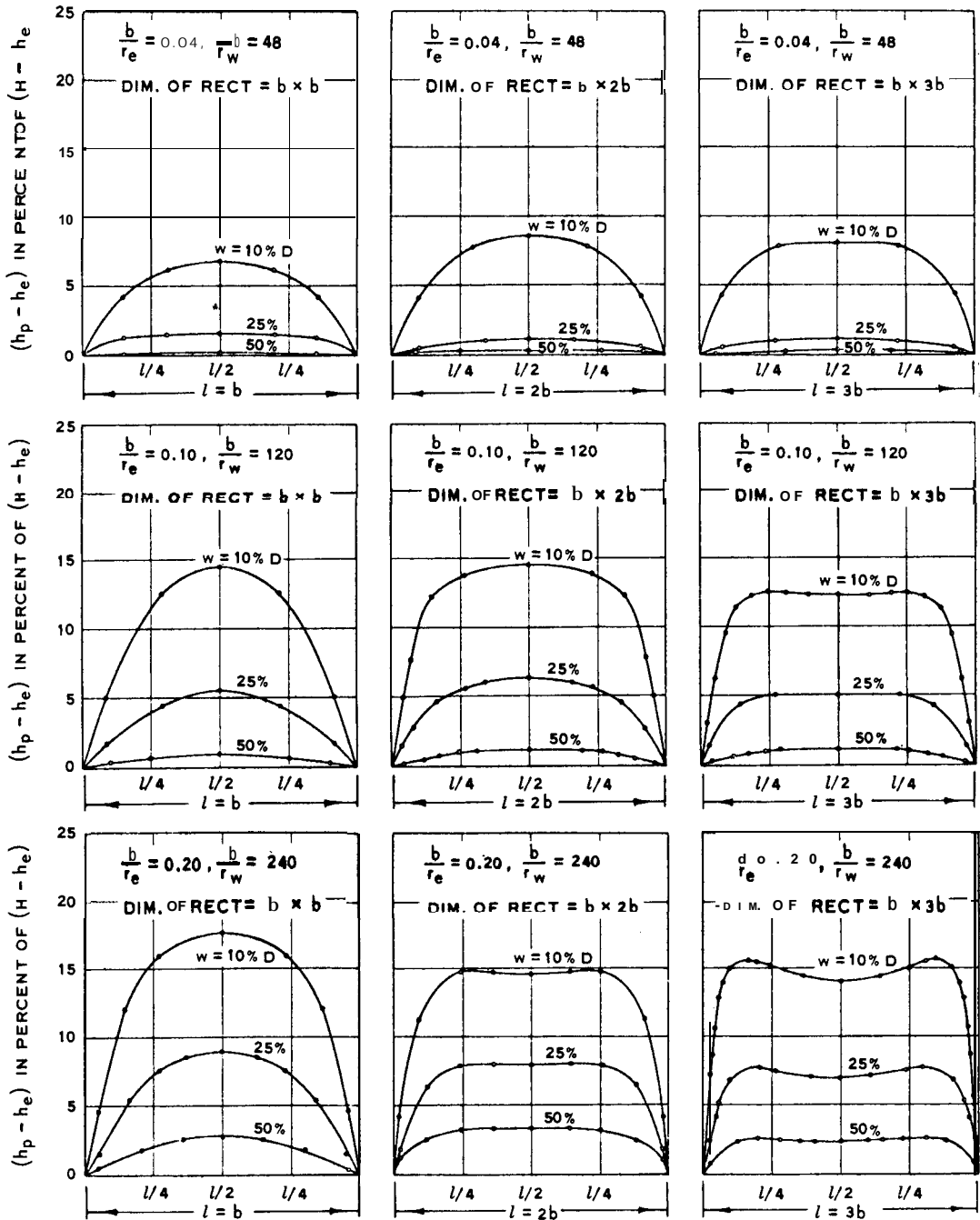

NOTE: HEAD, h_p , ALONG LINE A-A IN FIG. 4-8a CAN BE OBTAINED FROM CURVES ABOVE.

$$h_p = h_e + (h_p - h_e)$$

U. S. Army Corps of Engineers

Figure 4-9. Head within a partially penetrating rectangular slot; circular source; artesian flow.

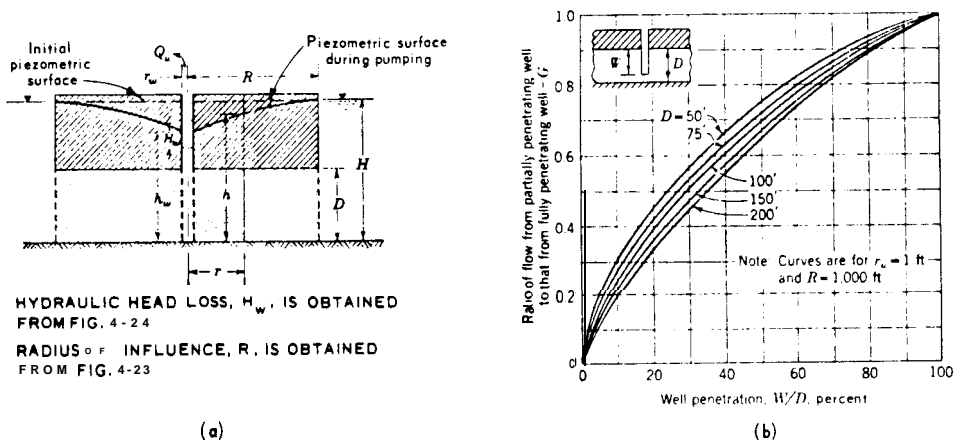

FULLY PENETRATING WELL

FLOW, Q_w $Q_w = \frac{2\pi kD(H-h)}{\ln(R/r)}$ (1) OR $Q_w = \frac{2\pi kD(H-h_w)}{\ln(R/r_w)}$ (2)

DRAWDOWN, $H-h$

$H-h = \frac{H-h_w}{\ln(R/r_w)} \ln \frac{R}{r}$ (3)

PARTIALLY PENETRATING WELL

FLOW, Q_{wp} $Q_{wp} = \frac{2\pi kD(H-h_w)G}{\ln(R/r_w)} = Q_w - 100\% \times G$ (4)

WHERE G IS EQUAL TO THE RATIO OF FLOW FROM A PARTIALLY PENETRATING WELL, Q_{wp} , TO THAT FOR A FULLY PENETRATING WELL FOR THE SAME DRAWDOWN, $H-h_w$, AT THE PERIPHERY OF THE WELLS.

APPROXIMATE VALUES OF G CAN BE COMPUTED FROM THE FORMULA:

$G = \frac{W}{D} \left(1 + 7\sqrt{r_w/2W} \cos \frac{\pi W/D}{2} \right)$ (5)

MORE EXACT VALUES CAN BE COMPUTED FROM THE FORMULA:

$G = \frac{\ln R/r_w}{\frac{D}{2W} \left[2 \ln \frac{4D}{r_w} - \ln \frac{\Gamma(0.875 W/D) \Gamma(0.125 W/D)}{\Gamma(1-0.875 W/D) \Gamma(1-0.125 W/D)} \right] - \ln \frac{4D}{R}}$ (6)

WHERE Γ IS THE GAMMA FUNCTION; W = WELL PENETRATION.

VALUES OF G FOR A TYPICAL LARGE-DIAMETER WELL ($r_w = 1.0$ FT) WITH A RADIUS OF INFLUENCE OF 1,000 FT ARE SHOWN IN (b) ABOVE.

DRAWDOWN, $H-h$

THE SHAPE OF THE DRAWDOWN CURVE IN THE VICINITY OF A PARTIALLY PENETRATING WELL CANNOT BE DETERMINED DIRECTLY FROM EQ 4 BUT CAN BE APPROXIMATED BY ASSUMING THE EFFECT OF WELL PENETRATION, W , IS INSIGNIFICANT BEYOND A DISTANCE, l , THAT IS GREATER THAN D . THE DRAWDOWN IS APPROXIMATED AS FOLLOWS:

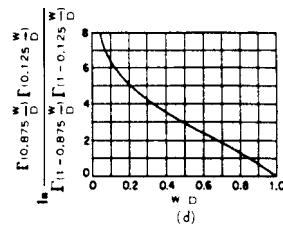
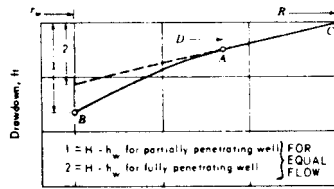

1. COMPUTE Q_{wp} FROM EQ 4 FOR A GIVEN DRAWDOWN OF 1 ON (c).
 2. COMPUTE $1-H-h_w$ FROM EQ 2 FOR A FULLY PENETRATING WELL FOR A DISCHARGE OF Q_{wp} (2 ON (c)).
 3. PLOT DRAWDOWN FOR FULLY PENETRATING WELL VS (LOG) r AS SHOWN BY LINE AC IN (c).
 4. DRAW A CURVED LINE FROM THE POINT (h_w, r_w) = POINT B ILLUSTRATION FOR THE PARTIALLY PENETRATING WELL TO POINT A.
- THE COMBINED CURVE, BAC, REPRESENTS AN APPROXIMATION OF THE DRAWDOWN CURVE FOR A PARTIALLY PENETRATING ARTESIAN WELL.

(Modified from "Foundation Engineering," G. A. Leonards, ed., 1962, McGraw-Hill Book Company. Used with permission of McGraw-Hill Book Company.)

Figure 4-10. Flow and drawdown for fully and partially penetrating single wells; circular source; artesian flow.

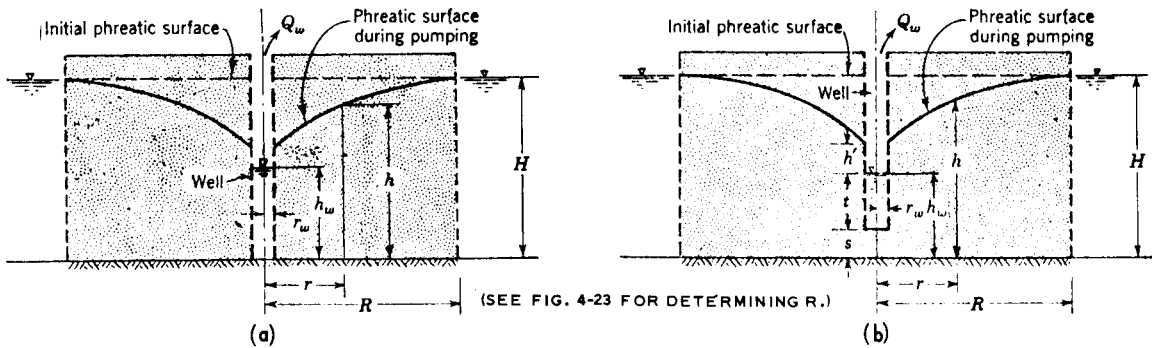

FULLY PENETRATING WELL

FLOW, Q_w , OR DRAWDOWN, $H^2 - h^2$, NEGLECTING HEIGHT OF FREE DISCHARGE, h' (CONDITION (a)).

$$Q_w = \frac{\pi k (H^2 - h^2)}{\ln (R/r)} \quad (1)$$

(1)

OR

$$Q_w = \frac{\pi k (H^2 - h_w^2)}{\ln (R/r_w)} \quad (2)$$

(2)

FLOW, Q_w , TAKING h' INTO ACCOUNT (b) CAN BE ESTIMATED ACCURATELY FROM EQ 2 USING HEIGHT OF WATER, $t + s$ ($s = 0$ FOR FULLY PENETRATING WELL), FOR THE TERM h_w .

FULLY OR PARTIALLY PENETRATING WELL

FLOW, Q_w , FOR ANY GRAVITY WELL WITH A CIRCULAR SOURCE

$$Q_w = \frac{\pi k [(H - s)^2 - t^2]}{\ln (R/r_w)} \left[1 + 0.30 t \frac{10r_w}{H} \right] \sin \frac{1.8s}{H} \quad (3)$$

(3)

DRAWDOWN, $H - h$ OR $H^2 - h^2$, WHERE h' IS ACCOUNTED FOR (OBTAIN Q_w FROM EQ 3)

WHERE $r > 1.5H$,

$$H^2 - h^2 = \frac{Q_w}{\pi k} \ln \frac{R}{r} \quad (4)$$

(4)

WHERE $r < 1.5H$,

FOR $r/h > 1.5$,

USE EQ 4

FOR $r/h < 1.5$,

$$H - h = \frac{Q_w P \ln (10R/H)}{\pi k H [1 - 0.8(s/H)^{1.5}]} \quad (5)$$

(5)

FOR $0.3 < r/h < 1.5$,

$$P = 0.13 \ln R/r$$

(6)

FOR $r/h < 0.3$,

$$P = \bar{C}_x + \Delta C$$

(7)

WHERE

$$\bar{C}_x = 0.13 \ln \frac{R}{r} - 0.0123 \ln^2 \frac{R}{10r} \quad (8)$$

(8)

AND

$$\Delta C = \frac{s}{h} \left[\left(\frac{1}{2.3} \ln \frac{R}{10r} \right) \left(1.2 \frac{s}{H} - 0.48 \right) + 0.113 \ln \frac{2.4H}{R} \ln \frac{R}{34r} \right] \quad (9)$$

(9)

(Modified from "Foundation Engineering," G. A. Leonards, ed., 1962, McGraw-Hill Book Company. Used with permission of McGraw-Hill Book Company.)

Figure 4-11. Flow and drawdown for fully and partially penetrating single wells; circular source; gravity flow.

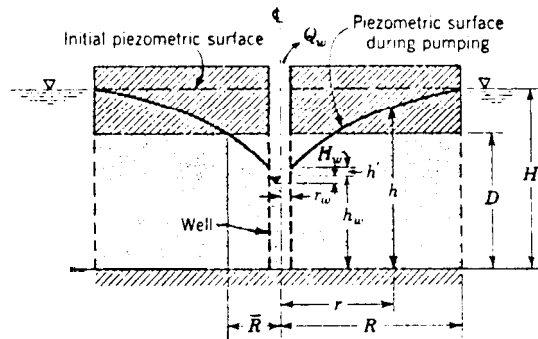

FLOW, Q_w , CAN BE COMPUTED FROM

$$Q_w = \frac{\pi k (2DH - D^2 - h_w^2)}{\ln (R/r_w)} \quad (1)$$

DRAWDOWN, $H-h$, CAN BE COMPUTED AT ANY DISTANCE FROM

$$H - h = H - h_w = \left(\frac{H - D}{\ln (R/r_w)} \ln \frac{r}{r_w} + \sqrt{D^2 - \frac{D^2 - h_w^2}{\ln (R/r_w)}} \ln \frac{R}{r} \right) \quad (2)$$

\bar{R} , DISTANCE FROM WELL AT WHICH FLOW CHANGES FROM GRAVITY TO ARTESIAN CAN BE COMPUTED FROM

$$\bar{R} = \frac{(D^2 - h_w^2) \ln R + 2D (H - D) \ln r_w}{2DH - D^2 - h_w^2} \quad (3)$$

\bar{R} IS DETERMINED FROM FIG. 4-23.

EQUATIONS 1 AND 2 ARE BASED ON THE ASSUMPTION THAT THE HEAD h_w AT THE WELL IS AT THE SAME ELEVATION AS THE WATER SURFACE IN THE WELL. THIS WILL NOT BE TRUE WHERE THE DRAWDOWN IS RELATIVELY LARGE. IN THE LATTER CASE, THE HEAD AT AND IN THE CLOSE VICINITY OF THE WELL CAN BE COMPUTED FROM EQ 4 THROUGH 9 (FIG. 4-11). IN THESE EQUATIONS THE VALUE OF Q_w USED IS THAT COMPUTED FROM EQ 1, ASSUMING h_w EQUAL TO THE HEIGHT OF WATER IN THE WELL, AND THE VALUE OF \bar{R} COMPUTED FROM EQ 3 IS USED IN LIEU OF R .

(Modified from "Foundation Engineering," G. A. Leonards, ed., 1962, McGraw-Hill Book Company. Used with permission of McGraw-Hill Book Company.)

Figure 4-12. Flow and drawdown for fully penetrating single well; circular source; combined artesian and gravity flows.

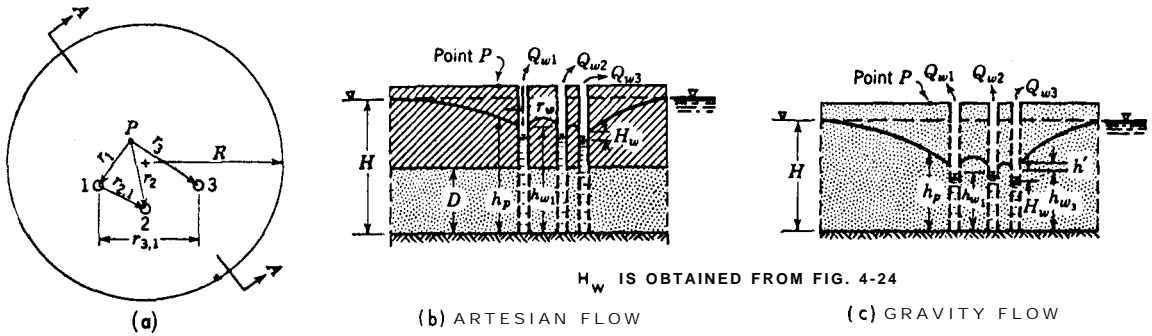

H_w IS OBTAINED FROM FIG. 4-24

(b) ARTESIAN FLOW

(c) GRAVITY FLOW

ARTESIAN FLOW

DRAWDOWN ($H - h_p$) AT ANY POINT P

$$H - h_p = \frac{F}{2\pi k D} \tag{1}$$

WHERE

$$F \dagger = \sum_{i=1}^{i=n} Q_{wi} \ln \left(\frac{R_i}{r_i} \right) \tag{2}$$

AND Q_{wi} = FLOW FROM WELL i

R_i = RADIUS OF INFLUENCE FOR WELL i †

r_i = DISTANCE FROM WELL i TO POINT P

n = NUMBER OF WELLS IN THE ARRAY

GRAVITY FLOW

DRAWDOWN ($H^2 - h_p^2$) AT ANY POINT P

$$H^2 - h_p^2 = \frac{F}{\pi k} \tag{3}$$

WHERE F IS COMPUTED FROM EQ 2

ARTESIAN OR GRAVITY FLOW

DRAWDOWN AT ANY WELL, j , FOR ARTESIAN OR GRAVITY FLOW CAN BE COMPUTED FROM EQ 1 OR 3 RESPECTIVELY, SUBSTITUTING F_w FOR F

WHERE

$$F_w = Q_{wj} \ln \left(\frac{R_j}{r_{wj}} \right) + \sum_{i=1}^{i=n-1} Q_{wi} \ln \left(\frac{R_i}{r_{ij}} \right) \tag{4}$$

AND Q_{wj} = FLOW FROM WELL j

r_{wj} = EFFECTIVE WELL RADIUS OF WELL j

R_j = RADIUS OF INFLUENCE FOR WELL j

r_{ij} = DISTANCE FROM EACH WELL TO WELL j

† DRAWDOWN FACTORS, F, FOR SEVERAL COMMON WELL ARRAYS ARE GIVEN IN FIG. 4-14

‡ FOR RELATIVELY SMALL DEWATERING SYSTEMS AND WHERE NO UNUSUAL BOUNDARY CONDITIONS EXIST, THE RADIUS OF INFLUENCE FOR ALL WELLS CAN BE ASSUMED CONSTANT AS IN (a) ABOVE. SEE FIG. 4-23 FOR DETERMINING THE VALUE OF R.

(Modified from "Foundation Engineering," G.A. Leonards, ed., 1962, McGraw-Hill Book Company. Used with permission of McGraw-Hill Book Company.)

Figure 4-13. Flow and drawdown for fully penetrating multiple wells; circular source; artesian and gravity flows.

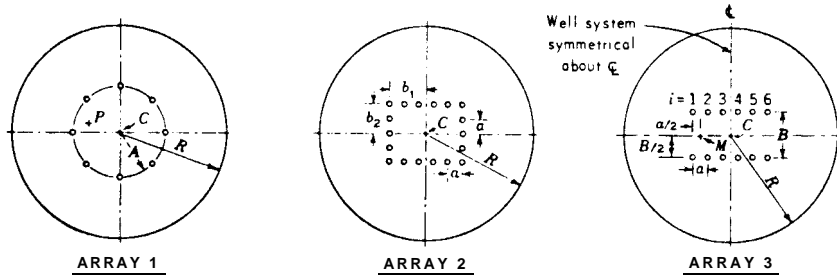

ALL WELLS ARE FULLY PENETRATING WITH A CIRCULAR SOURCE. THE FLOW, \$Q_w\$, FROM ALL WELLS IS EQUAL.

\$F_w\$ = DRAWDOWN FACTOR FOR ANY WELL IN THE ARRAY. \$F_c\$ = DRAWDOWN FACTOR FOR CENTER OF THE ARRAY. \$F_m\$ = DRAWDOWN FACTOR AT POINT \$M\$ IN ARRAY 3. \$n, R, Q_w, h_p, h_w, r_w, r_i, r_j, A, B, E, E_j\$ DEFINED IN FIG 4-13.

ARRAY 1. CIRCULAR ARRAY OF EQUALLY SPACED WELLS

$$F_w = Q_w \ln \frac{R^n}{n r_w A^{(n-1)}} \quad (1) \quad F_c = n Q_w \ln R/A \quad (2)$$

WHERE \$A\$ = DIMENSION SHOWN IN ARRAY 1 ABOVE.

DRAWDOWN AT POINTS \$P\$ AND \$C\$ FOR ARTESIAN FLOW CAN BE COMPUTED FROM

$$\text{DRAWDOWN} = (H - h_p) = \frac{(H - h_w) \left(\ln R + \sum_{i=1}^{i=n} \ln r_i \right)}{\ln \frac{R^n}{n r_w A^{(n-1)}}} \quad (3) \quad \text{DRAWDOWN} = (H - h_c) = \frac{(H - h_w) n \ln (R/A)}{\ln \frac{R^n}{n r_w A^{(n-1)}}} \quad (4)$$

DRAWDOWN AT \$C\$ FOR GRAVITY FLOW CAN BE COMPUTED FROM

$$(H - h_c) = H - \sqrt{H^2 - \frac{n(H^2 - h_w^2) \ln (R/A)}{\ln \frac{R^n}{n r_w A^{(n-1)}}}} \quad (5)$$

ARRAY 2. RECTANGULAR ARRAY OF EQUALLY SPACED WELLS

\$F_w\$ AND \$F_c\$ MAY BE APPROXIMATED FROM EQ. 1 AND 2, RESPECTIVELY, IF \$A_e\$ IS SUBSTITUTED FOR \$A\$;

$$A_e = \frac{4}{\pi} \sqrt{b_1 b_2} \quad (6)$$

\$F_w\$ AND \$F_c\$ CAN BE COMPUTED MORE EXACTLY FROM

$$F_w = Q_w \ln \frac{R}{r_{wj}} + \sum_{i=1}^{i=n-1} Q_w \ln \frac{R}{r_{ij}} \quad (7) \quad F_c = \sum_{i=1}^{i=n} Q_w \ln \frac{R}{r_i} \quad (8)$$

ARRAY 3. TWO PARALLEL LINES OF EQUALLY SPACED WELLS

$$F_c = 4 Q_w \sum_{i=1}^{i=n/4} \ln \frac{R}{1/2 \sqrt{a^2 (2i-1)^2 + B^2}} \quad F_m = 2 Q_w \sum_{i=1}^{i=n/4} \ln \frac{R}{1/2 \sqrt{a^2 (2i-3)^2 + B^2}}$$

WHERE \$i\$ = WELL NUMBER AS SHOWN IN THE ARRAY ABOVE.

NOTE THAT THE LOCATION OF \$M\$ IS MIDWAY BETWEEN THE TWO LINES OF WELLS AND CENTERED BETWEEN THE END TWO WELLS OF THE LINE. THIS POINT CORRESPONDS TO THE LOCATION OF THE MINIMUM DRAWDOWN WITHIN THE ARRAY.

VALUES DETERMINED FOR \$F_w, F_c\$, AND \$F_m\$ ARE SUBSTITUTED FOR \$F\$ IN EQ 1 AND 3 (FIG. 4-13) TO COMPUTE DRAWDOWN AT THE RESPECTIVE POINTS.

(Modified from "Foundation Engineering," G. A. Leonards, ed., 1962, McGraw-Hill Book Company. Used with permission of McGraw-Hill Book Company.)

Figure 4-14. Drawdown factors for fully penetrating circular, rectangular, and two-line well arrays; circular source; artesian and gravity flows.

CIRCULAR ARRAY OF n NUMBER OF EQUALLY SPACED WELLS

FULLY PENETRATING WELL

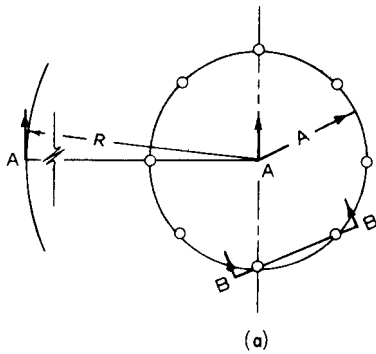

DRAWDOWN, $H - h_e$, PRODUCED BY PUMPING A FLOW OF Q_T FROM AN EQUIVALENT SLOT IS COMPUTED FROM EQ 1 (FIG. 4-6 OR 4-10) ($Q_T = nQ_w$) n = NUMBER OF WELLS; Q_w = FLOW FROM A WELL

HEAD LOSS DUE TO CONVERGING FLOW AT WELL

$$\Delta h_w = \frac{Q_w}{2\pi kD} \ln \frac{a}{2\pi r_w} = \frac{(H - h_e) \mathfrak{F}}{2\pi n} \ln \frac{a}{2\pi r_w} \quad (1)$$

TOTAL DRAWDOWN AT WELL (NEGLECTING HYDRAULIC HEAD LOSS, H_w)

$$H - h_w = H - h_e + \Delta h_w = \frac{Q_T}{kD} \left(\frac{1}{\mathfrak{F}} + \frac{1}{2\pi n} \ln \frac{a}{2\pi r_w} \right) \quad (2)$$

HEAD INCREASE MIDWAY BETWEEN WELLS

$$\Delta h_m = \frac{Q_w}{2\pi kD} \ln \frac{a}{\pi r_w} = \frac{(H - h_e) \mathfrak{F}}{2\pi r_w} \ln \frac{a}{\pi r_w} \quad (3)$$

DRAWDOWN MIDWAY BETWEEN WELLS

$$H - h_m = H - h_w - \Delta h_m = \frac{Q_T}{kD} \left[\frac{1}{\mathfrak{F}} - \frac{0.110}{n} \right] \quad (4)$$

HEAD INCREASE IN CENTER OF A RING OF WELLS, Δh_D , IS EQUAL TO Δh_w AND CAN BE COMPUTED FROM EQ 1. DRAWDOWN AT THE CENTER OF THE RING OF WELLS, $H - h_D$, IS EQUAL TO $H - h_w - \Delta h_w$ OR $H - h_e$ AND, CONSEQUENTLY, CAN BE COMPUTED FROM EQ 1 (FIG. 4-6).

FOR EQ 1 THROUGH 4:

FLOWS FROM ALL WELLS ARE EQUAL
SHAPE FACTOR \mathfrak{F} IS OBTAINED FROM FIG 4-6c.
 k = COEFFICIENT OF PERMEABILITY
ALL OTHER TERMS ARE EXPLAINED IN a, b, AND c

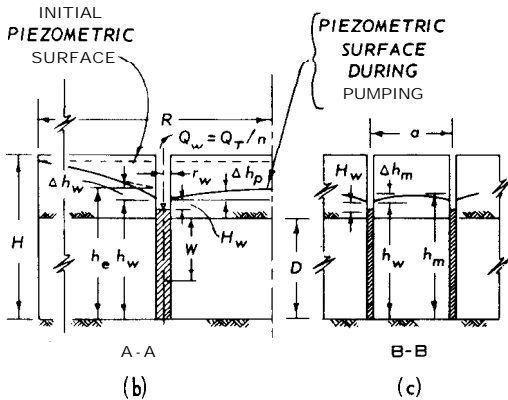

HYDRAULIC HEAD LOSS IN WELL (H_w) IS OBTAINED FROM FIG. 4-24.

U. S. Army Corps of Engineers

Figure 4-15. Flow and drawdown for fully penetrating circular well arrays; circular source; artesian flow

(6) Well or screen penetration W/D .

(a) Most of the equations and graphs presented in this manual for flow and drawdown to slots or well systems were basically derived for fully penetrating drainage slots or wells. Equations and graphs for partially penetrating slots or wells are generally based on those for fully penetrating drainage systems modified by model studies and, in some instances, mathematical derivations. The amount or percent of screen penetration required for effective pressure reduction or interception of seepage depends upon many factors, such as

thickness of the aquifer, distance to the effective source of seepage, well or wellpoint radius, stratification, required "wetted screen length," type and size of excavation, and whether or not the excavation penetrates alternating pervious and impervious strata or the bottom is underlain at a shallow depth by a less pervious stratum of soil or rock. Where a sizeable open excavation or tunnel is underlain by a fairly deep stratum of sand and wells are spaced rather widely, the well screens should penetrate at least 25 percent of the thickness of the aquifer to be dewatered below the

SEE FIG. 4-15, a, b, AND c FOR EXPLANATION OF TERMS NOT DEFINED IN THIS FIGURE.

DRAWDOWN, $H - h_e$, PRODUCED BY PUMPING A FLOW OF Q_T FROM AN EQUIVALENT SLOT, IS COMPUTED FROM EQ 1 (FIG. 4-6) FOR CIRCULAR SLOT AND EQ1 (FIG. 4-8) FOR RECTANGULAR SLOT.

HEAD LOSS DUE TO CONVERGING FLOW AT WELL

$$\Delta h_w = \frac{Q_w \theta_a}{kD} = \frac{(H - h_e) \mathcal{S} \theta_a}{n} \quad (1)$$

TOTAL DRAWDOWN AT WELL (NEGLECTING H_w)

$$H - h_w = H - h_e + \Delta h_w = \frac{Q_T}{kD} \left(\frac{1}{\mathcal{S}} + \frac{\theta_a}{n} \right) \quad (2)$$

HEAD INCREASE MIDWAY BETWEEN WELLS

$$\Delta h_m = \frac{Q_w \theta_m}{kD} = \frac{(H - h_e) \mathcal{S} \theta_m}{n} \quad (3)$$

DRAWDOWN MIDWAY BETWEEN WELLS

$$H - h_m = H - h_w - \Delta h_m = \frac{Q_T}{kD} \left[\frac{1}{\mathcal{S}} + \frac{1}{n} (\theta_a - \theta_m) \right] \quad (4)$$

HEAD INCREASE IN CENTER OF A RING OF WELLS, Δh_D , IS EQUAL TO Δh_w AND CAN BE COMPUTED FROM EQ 1.

DRAWDOWN AT THE CENTER OF A RING OF WELLS, $H - h_D$, IS EQUAL TO $H - h_w - \Delta h_w$ OR $H - h_e$ AND, CONSEQUENTLY, CAN BE COMPUTED FROM EQ 1 (FIG. 4-6).

FOR EQ 1 THROUGH 4: $h_e = h_w + \Delta h_w$

FLDWS FROM ALL WELLS ARE EQUAL.

θ_a AND θ_m ARE DRAWDOWN FACTORS OBTAINED FROM FIG. 4-21 (a AND b, RESPECTIVELY).

\mathcal{S} FROM FIG. 4-6 AND 4-0.

U.S. Army Corps of Engineer?

Figure 4-16. Flow and drawdown for partially penetrating circular and rectangular well arrays; circular source; artesian flow.

bottom of the excavation and more preferably 50 to 100 percent. Where the aquifer(s) to be dewatered is stratified, the drainage slots or well screens should fully penetrate all the strata to be dewatered. If the bottom of an excavation in a pervious formation is underlain at a shallow depth by an impervious formation and the amount of "wetted screen length" avail-

able is limited, the drainage trench or well screen should penetrate to the top of the underlying less pervious stratum. The hydraulic head loss through various sizes and types of header or discharge pipe, and for certain well screens and (clean) filters, as determined from laboratory and field tests, are given in figures 4-24 and 4-25.

EQUATIONS FOR FLOW AND **DRAWDOWN** FOR A FULLY **PENETRATING WELL** WITH A **LINE SOURCE** OF INFINITE LENGTH WERE DEVELOPED UTILIZING THE METHOD OF IMAGE WELLS. THE **IMAGE WELL** IS CONSTRUCTED AS SHOWN IN (a) BELOW.

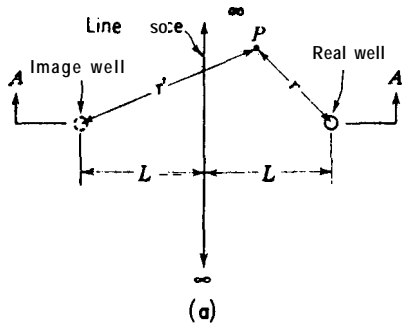

FLOW, Q_w

ARTESIAN FLOW

$$Q_w = \frac{2\pi k D (H - h_w)}{\ln (2L/r_w)} \quad (1)$$

DRAWDOWN AT ANY POINT, **P**, LOCATED A DISTANCE, **r**, FROM THE WELL.

$$H - h = \frac{Q_w}{2\pi k D} \ln \left(\frac{r'}{r} \right) \quad (2)$$

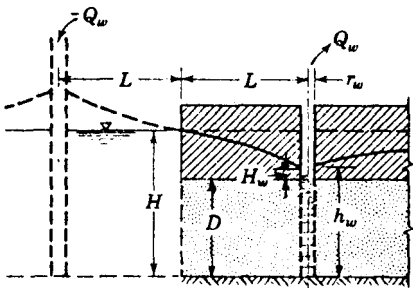

(b) ARTESIAN FLOW

FLOW, Q_w

GRAVITY FLOW

$$Q_w = \frac{\pi k (H^2 - h_w^2)}{\ln (2L/r_w)} \quad (3)$$

DRAWDOWN AT ANY POINT, **P**, LOCATED A DISTANCE, **r**, FROM THE WELL.

$$H^2 - h^2 = \frac{Q_w}{\pi k} \ln \frac{r'}{r} \quad (4)$$

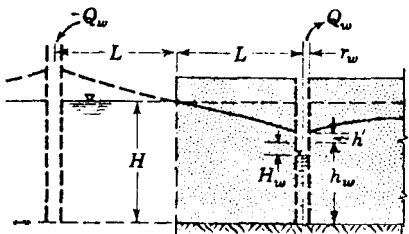

(c) GRAVITY FLOW

IN THE EQUATIONS ABOVE, THE DISTANCE TO THE LINE SOURCE MUST BE COMPARED TO THE CIRCULAR **RADIUS** OF INFLUENCE, **R**, FOR THE WELL. IF **2L** IS GREATER THAN **R**, THE WELL WILL PERFORM AS IF SUPPLIED BY A CIRCULAR SOURCE OF SEEPAGE, AND SOLUTIONS FOR A LINE SOURCE OF SEEPAGE ARE NOT APPLICABLE.

SEE FIG. 4-23 FOR DETERMINING THE VALUE OF **R**.

SEE FIG. 4-24 FOR DETERMINING THE VALUE OF H_w .

(Modified from "Foundation Engineering," G. A. Leonards, ed., 1962, McGraw-Hill Book Company. Used with permission of McGraw-Hill Book Company.)

Figure 4-17. Flow and drawdown for fully penetrating single well; line source; artesian and gravity flows.

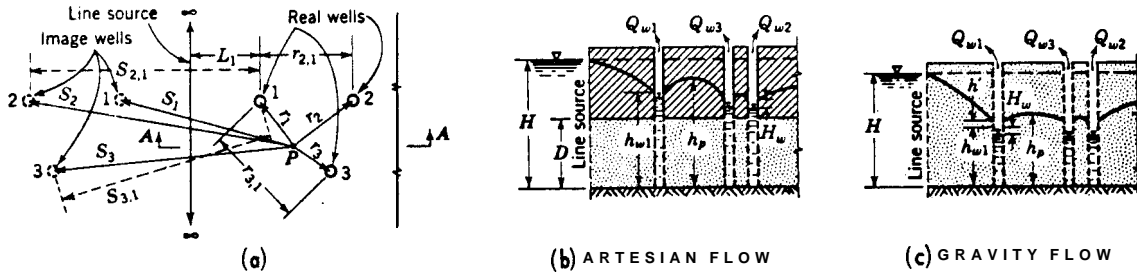

CONSTRUCTION OF THE IMAGE WELLS IS DISCUSSED IN THE TEXT OF PARAGRAPH 4-2

ARTESIAN FLOW

DRAWDOWN (H - hp) AT ANY POINT P

$$H - h_p = \frac{F'_p}{2\pi kD} \tag{1}$$

WHERE

$$F'_p = \sum_{i=1}^{i=n} Q_{wi} \ln \frac{S_i}{r_i} \tag{2}$$

AND Q_{wi} = FLOW FROM WELL i

S_i = DISTANCE FROM IMAGE WELL i TO POINT P

r_i = DISTANCE FROM WELL i TO POINT P

n = NUMBER OF REAL WELLS

GRAVITY FLOW

DRAWDOWN (H² - h_p²) AT ANY POINT P

$$H^2 - h_p^2 = \frac{F'_p}{\pi k} \tag{3}$$

WHERE F'_p IS COMPUTED FROM EQ 2.

ARTESIAN OR GRAVITY FLOW

DRAWDOWN AT ANY WELL, j, FOR ARTESIAN OR GRAVITY FLOW CAN BE COMPUTED FROM EQ 1 OR 3, RESPECTIVELY, SUBSTITUTING F'_{wj} FOR F'_p

WHERE

$$F'_{wj} = Q_{wj} \ln \frac{2L_j}{r_{wj}} + \sum_{i=2}^{i=n} Q_{wi} \ln \frac{S_{ij}}{r_{ij}} \tag{4}$$

AND Q_{wj} = FLOW FROM WELL j

Q_{wi} = FLOW FROM WELL i

L_j = DISTANCE FROM LINE SOURCE TO WELL j

S_{ij} = DISTANCE FROM IMAGE WELL i TO WELL j

r_w = RADIUS OF WELL

n = NUMBER OF REAL WELLS

r_{ij} = DISTANCE FROM EACH WELL TO WELL j

DRAWDOWN FACTORS, F' , FOR SEVERAL COMMON WELL ARRAYS ARE GIVEN IN FIG. 4-19

(Modified from "Foundation Engineering," G. A. Leonards, ed., 1962, McGraw-Hill Book Company, Used with permission of McGraw-Hill Book Company.)

Figure 4-18. Flow and drawdown for fully penetrating multiple wells; line source; artesian and gravity flows.

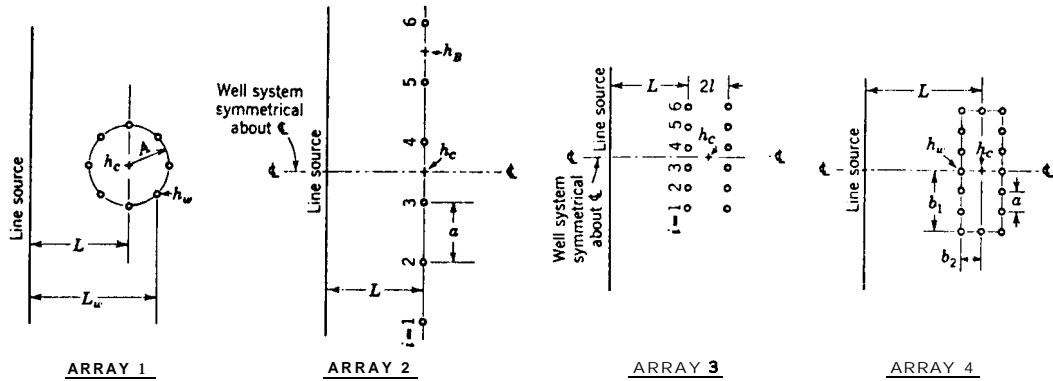

F'_c = DRAWDOWN FACTOR FOR CENTER OF ARRAY.
 F'_w = DRAWDOWN FACTOR FOR ANY WELL OF ARRAY
 F'_B = DRAWDOWN FACTOR FOR MIDWAY BETWEEN LAST TWO WELLS (ARRAY 2).

SEE EQ 1 AND 3 (FIG. 4-13) FOR DEFINITION OF F

VALUES DETERMINED FOR DRAWDOWN FACTORS ARE SUBSTITUTED INTO EQ 1 OR 3 (FIG. 4-18).

ALL WELLS ARE FULLY PENETRATING. FLOWS FROM ALL WELLS ARE EQUAL.

SEE FIG. 4-18 FOR EXPLANATION OF TERMS NOT DEFINED IN THIS FIGURE.

ARRAY 1 - CIRCULAR ARRAY OF EQUALLY SPACED WELLS

$$F'_c = \frac{Q_w}{2} \sum_{i=1}^{i=n} \ln \left[1 + 4 \left(\frac{L}{A} \right)^2 - 4 \left(\frac{L}{A} \right) \cos \left((i-1) \frac{2\pi}{n} \right) \right] \quad (1)$$

IF $\frac{L}{A} \geq 2$

$$F'_c = Q_w n \ln \frac{2L}{A} \quad (2)$$

$$F'_w = Q_w \left(n \ln \frac{2L_w}{A} + \ln \frac{A}{nr_w} \right) \quad (3)$$

ARRAY 2 - SINGLE LINE OF EQUALLY SPACED WELLS

$$F'_c = 2Q_w \sum_{i=1}^{i=n/2} \ln \sqrt{1 + \left[\frac{2L}{(a/2)(n+1-2i)} \right]^2} \quad (4)$$

$$F'_B = Q_w \sum_{i=1}^{i=n} \ln \sqrt{1 + \left[\frac{2L}{(a/2)(2i-3)} \right]^2} \quad (5)$$

WHERE $n = \infty$ USE EQUATIONS GIVEN IN FIG. 4-20, 4-21, AND 4-22.

ARRAY 3 - TWO PARALLEL LINES OF EQUALLY SPACED WELLS

$$F'_c = 2Q_w \sum_{i=1}^{i=n/4} \left\{ \ln \sqrt{1 + \left[\frac{2L+l}{(a/4)(n+2-4i)} \right]^2} + \ln \sqrt{1 + \left[\frac{2L+3l}{(a/4)(n+2-4i)} \right]^2} \right\} \quad (6)$$

ARRAY 4 - RECTANGULAR ARRAY OF EQUALLY SPACED WELLS

APPROXIMATE METHOD. COMPUTE F'_w AND F'_c FROM EQ 1 OR 2 AND 3 RESPECTIVELY, WHERE A_e IS SUBSTITUTED FOR A AND

$$A_e = \frac{4}{\pi} \sqrt{b_1 b_2} \quad (7)$$

EXACT METHOD. COMPUTE F'_c AND F'_w FROM EQ 2 AND 4 (FIG. 4-18), RESPECTIVELY.

(Modified from "Foundation Engineering," G. A. Leonards, ed., 1962, McGraw-Hill Book Company. Used with permission of McGraw-Hill Book Company.)

Figure 4-19. Drawdown factors for fully penetrating circular, line, two-line, and rectangular well arrays; line source; artesian and gravity flows.

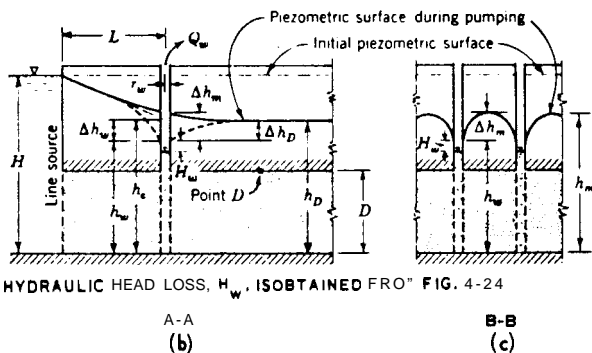
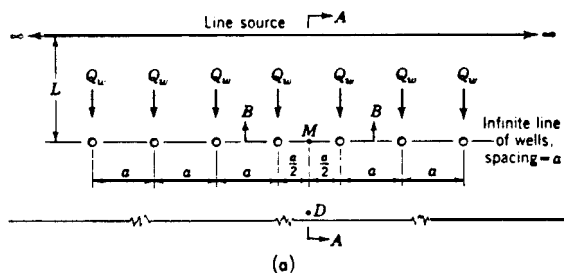

HYDRAULIC HEAD LOSS, H_w , IS OBTAINED FROM FIG. 4-24

DRAWDOWN, $H - h_e$, PRODUCED BY PUMPING Q_w FROM AN EQUIVALENT CONTINUOUS SLOT IS COMPUTED FROM $\frac{Q_w L}{kD\alpha}$.

HEAD LOSS DUE TO CONVERGING FLOW AT WELL

$$\Delta h_w = \frac{Q_w}{2\pi kD} \ln \frac{a}{2\pi r_w} \quad (1)$$

TOTAL DRAWDOWN AT WELL (NEGLECTING HYDRAULIC HEAD LOSS, H_w)

$$H - h_w = H - h_e + \Delta h_w = \frac{Q_w L}{kD\alpha} + \frac{Q_w}{2\pi kD} \ln \frac{a}{2\pi r_w} \quad (2)$$

HEAD INCREASE MIDWAY BETWEEN WELLS

$$\Delta h_m = \frac{Q_w}{2\pi kD} \ln \frac{a}{\pi r_w} \quad (3)$$

DRAWDOWN MIDWAY BETWEEN WELLS

$$H - h_m = H - h_w - \Delta h_m = \frac{Q_w L}{kD\alpha} - 0.11 \frac{Q_w}{kD} \quad (4)$$

HEAD INCREASE Δh_D DOWNSTREAM OF WELLS IS EQUAL TO Δh_m , EQ 1.

DRAWDOWN $H - h_D$ DOWNSTREAM OF WELLS IS EQUAL TO $H - h_w - \Delta h_w$ OR $H - h_e$ AND, CONSEQUENTLY, CAN BE COMPUTED FROM EQ 1 (FIG. 4-1), WHERE $x = a$, AND $Q = Q_w$. $H - h_D$ CAN ALSO BE COMPUTED FROM

$$H - h_D = \frac{h_D - h_w}{(\alpha/2\pi L)(\ln a/2\pi r_w)} \quad (5)$$

(Modified from "Foundation Engineering," G. A. Leonards, ed., 1962, McGraw-HZ Book Company. Used with permission of McGraw-Hill Book Company.)

Figure 4-20. Flow and drawdown for fully penetrating infinite line of wells; line source; artesian flow

SEE DRAWINGS IN FIG. 4-6 AND FIGURES (a) AND (b) BELOW FOR DEFINITIONS OF TERMS IN EQUATIONS.

DRAWDOWN, $H - h_e$, PRODUCED BY PUMPING Q_w FROM AN EQUIVALENT CONTINUOUS SLOT IS COMPUTED FROM EQ1(FIG.4-3).

HEAD LOSS DUE TO CONVERGING FLOW AT WELL

$$\Delta h_w = \frac{Q_w \theta_a}{kD} \tag{1}$$

TOTAL DRAWDOWN AT WELL (NEGLECTING H_w)

$$H - h_w = H - h_e + \Delta h_w = \frac{Q_w}{kD} \left(\frac{L}{a} + \theta_a \right) \tag{2}$$

HEAD INCREASE MIDWAY BETWEEN WELLS

$$\Delta h_m = \frac{Q_w \theta_m}{kD} \tag{3}$$

DRAWDOWN MIDWAY BETWEEN WELLS

$$H - h_m = H - h_w - \Delta h_m = \frac{Q_w}{kD} \left(\frac{L}{a} + \theta_a - \theta_m \right) \tag{4}$$

HEAD INCREASE Δh_D DOWNSTREAM OF WELLS IS EQUAL TO Δh_w , EQ 1.

DRAWDOWN $H - h_D$ DOWNSTREAM OF WELLS IS EQUAL TO $H - h_w - \Delta h_w$ OR $H - h_e$ AND, CONSEQUENTLY, CAN BE COMPUTED FROM EQ 1 (FIG. 4-3).

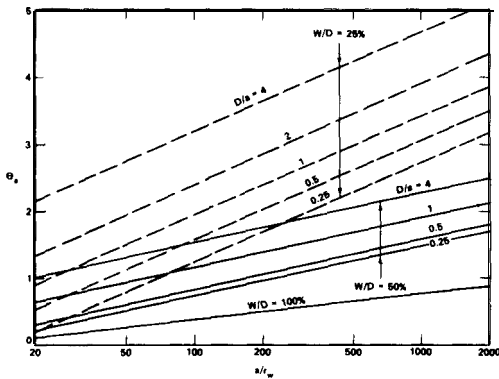

(a)

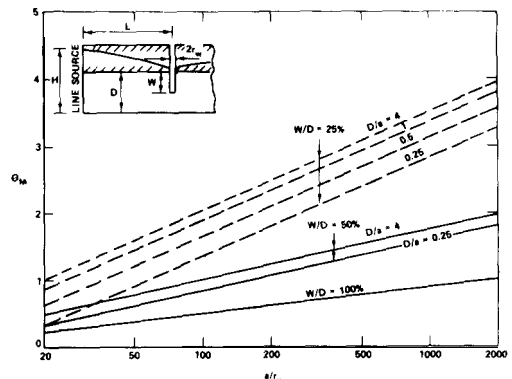

(b)

(Modified from "Foundation Engineering," G. A. Leonards, ed., 1962, McGraw-Hill Book Company. Used with permission of McGraw-Hill Book Company.)

Figure 4-21. Flow and drawdown for fully and partially penetrating infinite line of wells; line source; artesian flow.

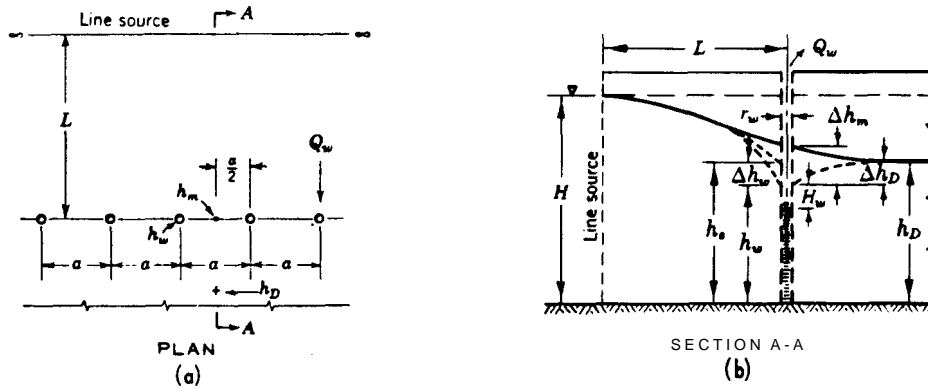

DRAWDOWN, $H^2 - h_e^2$, PRODUCED BY PUMPING Q_w FROM AN EQUIVALENT CONTINUOUS SLOT IS COMPUTED FROM $\frac{2Q_w L}{ka}$.

HEAD LOSS DUE TO CONVERGING FLOW AT WELL

$$h_e^2 - h_w^2 = \frac{Q_w}{\pi k} \ln \frac{a}{2\pi r_w} \tag{1}$$

TOTAL DRAWDOWN AT WELL

$$H^2 - h_w^2 = H^2 - h_e^2 = \frac{2Q_w L}{ka} + \frac{Q_w}{\pi k} \ln \frac{a}{2\pi r_w} \tag{2}$$

HEAD INCREASE MIDWAY BETWEEN WELLS

$$h_m^2 - h_w^2 = \frac{Q_w}{\pi k} \ln \frac{a}{\pi r_w} \tag{3}$$

DRAWDOWN MIDWAY BETWEEN WELLS

$$H^2 - h_m^2 = H^2 - h_w^2 - (h_m^2 - h_w^2) = \frac{Q_w}{k} \left(\frac{2L}{a} - \frac{\ln 2}{\pi} \right) \tag{4}$$

HEAD INCREASE Δh_D DOWNSTREAM OF WELLS IS EQUAL TO Δh_w (EQ 1).

DRAWDOWN $H^2 - h_D^2$ DOWNSTREAM OF WELLS IS EQUAL TO

$$H^2 - h_D^2 = \frac{h_w^2 - h_e^2}{2\pi L} \ln \frac{a}{2\pi r_w} \tag{5}$$

(Modified from "Foundation Engineering," G. A. Leonards, ed., 1962, McGraw-Hill Book Company. Used with permission of McGraw-Hill Book Company.)

Figure 4-22. Flow and drawdown for fully penetrating infinite line of wells; line source; gravity flow.

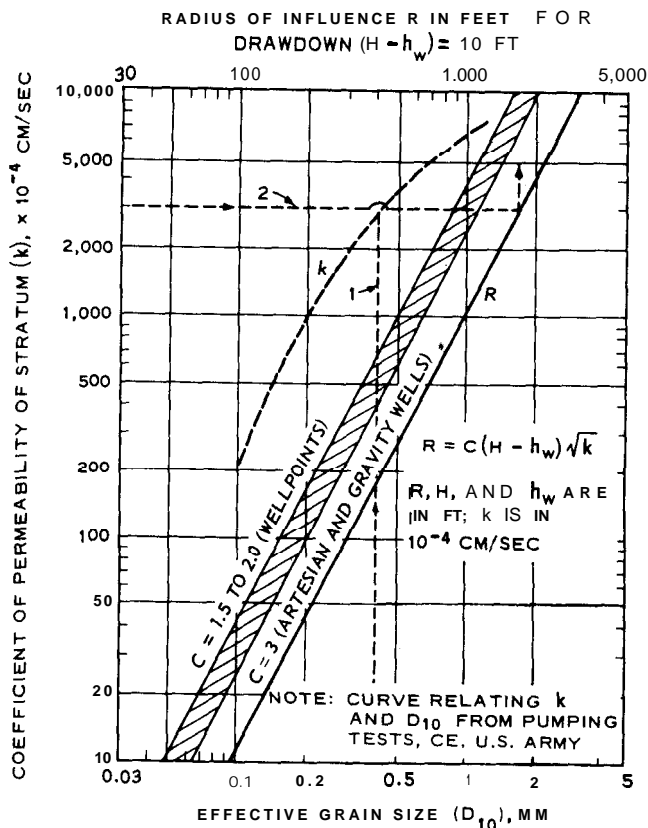

1. R DETERMINED WHEN ONLY D_{10} IS KNOWN.
2. R DETERMINED WHEN k IS KNOWN.

RADIUS OF INFLUENCE, R , CAN BE ESTIMATED FOR BOTH ARTESIAN AND GRAVITY FLOWS BY

$$R = C (H - h_w) \sqrt{k} \tag{1}$$

WHERE R , H , AND h_w ARE DEFINED PREVIOUSLY AND EXPRESSED IN FEET. COEFFICIENT OF PERMEABILITY, k , IS EXPRESSED IN 10^{-4} CM/SEC.

AND $C = 3$ FOR ARTESIAN AND GRAVITY FLOWS TO A WELL.

$C = 1.5$ TO 2.0 FOR A SINGLE LINE OF WELLPOINTS.

THE VALUE OF R FOR $(H - h_w) = 10$ FT CAN BE DETERMINED FROM THE PLOT HEREIN WHEN EITHER THE D_{10} SIZE OR PERMEABILITY OF THE MATERIAL IS KNOWN. THE VALUE OF R WHEN $(H - h_w) \neq 10$ CAN BE DETERMINED BY MULTIPLYING THE R VALUE OBTAINED FROM THE PLOT BY THE RATIO OF THE ACTUAL VALUE OF $(H - h_w)$ TO 10 FT.

A DISCUSSION ON THE DETERMINATION OF R FROM EQ 1 AND PUMPING TESTS IS CONTAINED IN PARAGRAPH 4-2a(3) OF THE TEXT.

(Modified from "Foundation Engineering," G. A. Leonards, ed., 1962, McGraw-Hill Book Company. Used with permission of McGraw-Hill Book Company.)

Figure 4-23. Approximate radius of influence R .

(b) Head losses in the screened section of a well H_s are calculated from figure 4-24b. This head loss is based on equal inflow per unit of screen surface and turbulent flow inside the well and is equivalent to the entire well flow passing through one-half the screen length. Other head losses can be determined directly from figure 4-24. Hydraulic head loss within a well-point system can be estimated from figure 4-25. As stated in a(4) above, flow into a well can be impeded by the lack of "wetted screen length," in addition to hydraulic head losses in the filter or through the screens and/or chemical or mechanical clogging of the aquifer and filter.

b. Flow to a drainage slot.

(1) *Line drainage slots.* Equations presented in figures 4-1 through 4-5 can be used to compute flow and head produced by pumping either a single or a double continuous slot of infinite length. These equations assume that the source of seepage and the drainage slot are infinite in length and parallel and that seepage enters the pervious stratum from a vertical line source. In actuality, the slot will be of finite length, the flow at the ends of the slot for a distance of about $L/2$ (where L equals distance between slot and source) will be greater, and the drawdown will be less than for the central portion of the slot. Flow to the ends of a fully penetrating slot can be estimated, if necessary, from flow-net analyses subsequently presented.

Table 4-1. Index to Figures for Flow, Head, or Drawdown Equations for Given Corrections

Index	Assumed Source of Seepage	Drainage System	Type of Flow	Penetration	Figure	
Flow to a slot	Line	Line slot	A, G, C	F	4-1, 4-2	
	Line	Line slot	A; G; C	P	4-2, 4-3	
	Two-line	Line slot	A, G	P, F	4-4	
	Two-line	Two-line slots	A, G	P	4-5	
	Circular	Circular slots	A	P, F	4-6, 4-7	
	Circular	Rectangular slots	A	P, F	4-8, 4-9	
Flow to wells	Circular	Single well	A	P, F	4-10	
	Circular	Single well	C	P, F	4-11	
	Circular	Single well	C	F	4-12	
	Circular	Multiple wells	A, G	F	4-13	
	Circular	Circular, rectangular, and two-line arrays	A, G	F	4-14	
	Circular	Circular array	A	F	4-15	
	Circular	Circular and rectangular array	A	P	4-16	
	Single line	Single well	A, G	F	4-17	
	Single line	Multiple wells	A, G	F	4-18	
	Single line	Circular, line, two-line, and rectangular arrays	A, G	F	4-19	
	Single line	Infinite line	A	F	4-20	
	Single line	Infinite line	A	P, F	4-21	
	Single line	Infinite line	G	F	4-22	
	Other	Approximate radius of influence				4-23
		Hydraulic head loss in a well				4-24
Hydraulic head loss in various wellpoints					4-25	
Equivalent length of straight pipe for various fittings					4-26	
Shape factors for wells of various penetrations centered inside a circular source					4-27	
Flow and drawdown for slots from flow-net analyses					4-28	
Flow and drawdown for wells from flow-net analyses					4-29	
Diagrammatic layout of electrical analogy model					4-30	

Note: A = artesian flow; G = gravity flow; C = combined artesian-gravity flow; F = fully penetrating; P = partially penetrating.

TOTAL HYDRAULIC HEAD LOSS IN A WELL (H_w) IS

$$H_w = H_e + H_s + H_r + H_v \quad (102)$$

WHERE H_e = ENTRANCE HEAD LOSS (SCREEN AND FILTER)
ESTIMATE FROM CURVE **a**.

H_s = HEAD LOSS IN SCREENED SECTION OF WELL:
ESTIMATE FROM CURVE **b** FOR A DISTANCE OF ONE-
HALF THE SCREEN LENGTH.

H_r = HEAD LOSS WITHIN THE RISER AND CONNECTIONS.
ESTIMATE FROM CURVE **b**. (SEE FIG. 4-26 FOR THE
EQUIVALENT LENGTH OF STRAIGHT PIPE FOR VARI-
OUS FITTINGS.)

H_v = VELOCITY HEAD LOSS. ESTIMATE FROM CURVE **c**

THE VALUE OF H_w MUST BE SUBTRACTED FROM THE COMPUTED
VALUE OF h_w TO OBTAIN THE LIFT OR WATER LEVEL IN A WELL.

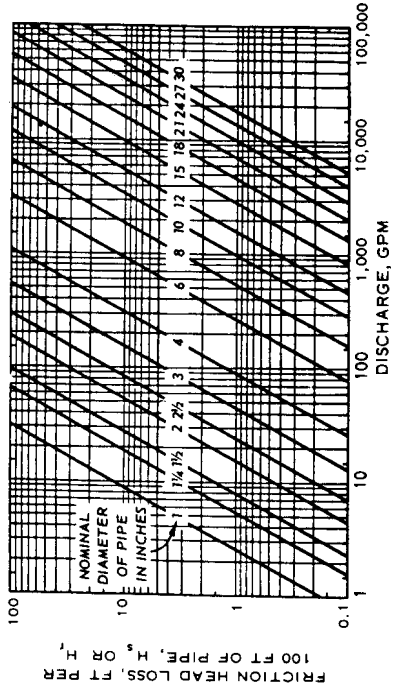
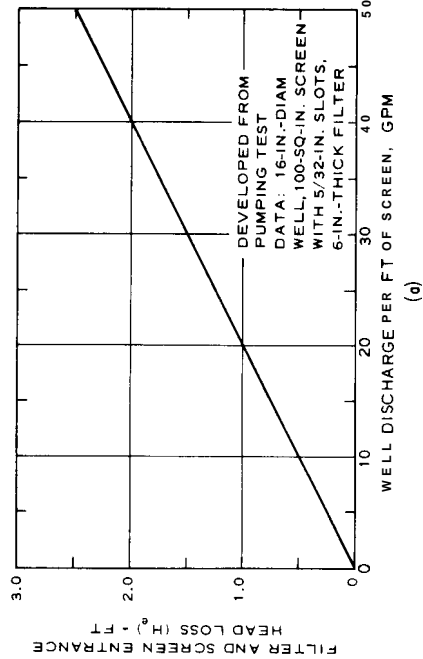

BASED ON HAZEN-WILLIAMS EQUATION WITH $C=100$; MULTIPLY LOSSES BY $(100/C)^{1.85}$ FOR VALUES OF C OTHER THAN 100

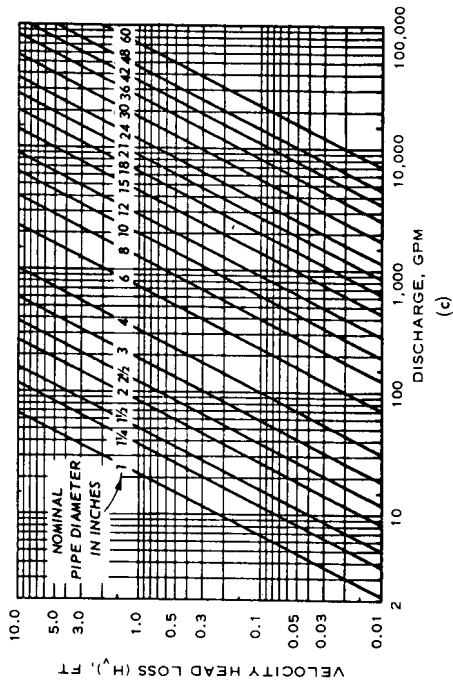

(Modified from "Foundation Engineering," G. A. Leonards, ed., 1962, McGraw-Hill Book Company. Used with permission of McGraw-Hill Book Company.)

Figure 4-24. Hydraulic head loss in a well.

TOTAL HYDRAULIC HEAD LOSS IN A WELLPOINT (H_w) IS

$$H_w = H_e + H_s + H_r + H_v$$

WHERE

H_e = ENTRANCE HEAD LOSS (WELLPOINT AND FILTER)

H_s = FRICTION HEAD LOSS WITHIN THE WELLPOINT

H_r = FRICTION HEAD LOSS IN RISER, SWING CONNECTION, AND VALVE

H_v = VELOCITY HEAD LOSS IN RISER, SWING CONNECTION, AND VALVE

HYDRAULIC HEAD LOSSES FOR TYPICAL WELLPOINTS AND RISERS CAN BE ESTIMATED FROM THE PLOTS BELOW.

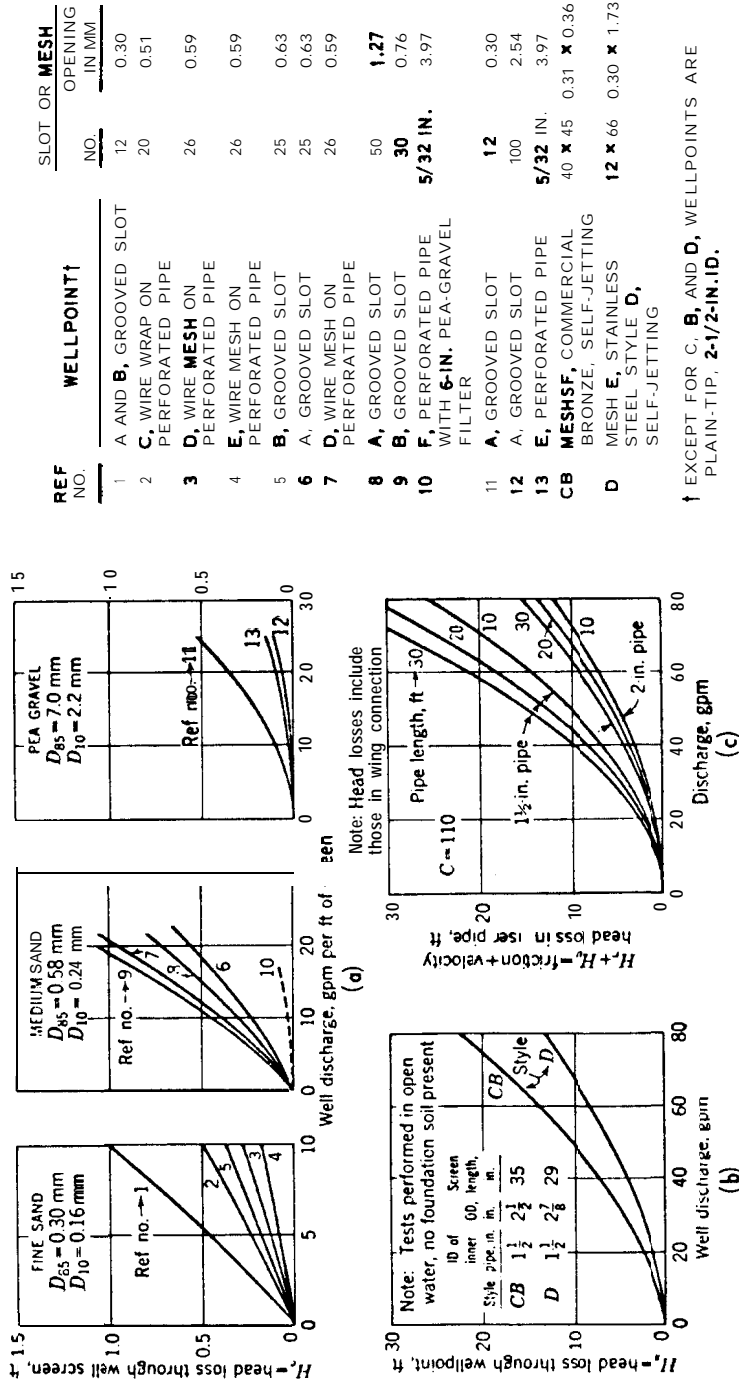

† EXCEPT FOR C, B, AND D, WELLPOINTS ARE PLAIN-TIP, 2-1/2-IN.-ID.

(Modified from "Foundation Engineering," G. A. Leonards, ed., 1962, McGraw-Hill Book Company. Used with permission of McGraw-Hill Book Company.)

Figure 4-25. Hydraulic head loss in various wellpoints.

(2) *Circular and rectangular slots.* Equations for flow and head or drawdown produced by circular and rectangular slots supplied by a circular seepage source are given in figures 4-6 through 4-9. Equations for flow from a circular seepage source assume that the slot is located in the center of an island of radius R . For many dewatering projects, R is the radius of influence rather than the radius of an island, and procedures for determining the value of R are discussed in a(3) above. Dewatering systems of relatively short length are considered to have a circular source where they are far removed from a line source such as a river or shoreline.

(3) *Use of slots for designing well systems.* Wells can be substituted for a slot; and the flow Q_w , drawdown at the well ($H-h_w$) neglecting hydraulic head losses at and in the well, and head midway between the wells above that in the wells Δh_m can be computed from the equations given in figures 4-20, 4-21, and 4-22 for a (*single*) *line source* for artesian and gravity flow for both “fully” and “partially” penetrating wells where the well spacing a is substituted for the length of slot x .

(4) *Partially penetrating slots.* The equations for gravity flow *topartially* penetrating slots are only considered valid for relatively high-percent penetrations.

c. Flow to wells.

(1) Flow to wells from a circular source.

(a) Equations for flow and drawdown produced by a single well supplied by a circular source are given in figures 4-10 through 4-12. It is apparent from figure 4-11 that considerable computation is required to determine the height of the phreatic surface and resulting drawdown in the immediate vicinity of a gravity well (r/h less than 0.3). The drawdown in this zone usually is not of special interest in dewatering systems and seldom needs to be computed. However, it is always necessary to compute the water level in the well for the selection and design of the pumping equipment.

(b) The general equations for flow and drawdown produced by pumping a group of wells supplied by a circular source are given in figure 4-13. These equations are based on the fact that the drawdown at any point is the summation of drawdowns produced at that point by each well in the system. The drawdown factors F to be substituted into the general equations in figure 4-13 appear in the equations for both artesian and gravity flow conditions. Consequently, the factors given in figure 4-14 for commonly used well arrays are applicable for either condition.

(c) Flow and drawdown for circular well arrays can also be computed, in a relatively simple manner, by first considering the well system to be a slot, as shown in figure 4-15 or 4-16. However, the piezometric head in the vicinity of the wells (or wellpoints)

will not correspond exactly to that determined for the slot due to convergence of flow to the wells. The piezometric head in the vicinity of the well is a function of well flow Q_w ; well spacing a ; well penetration W ; effective well radius r_w ; aquifer thickness D , or gravity head H ; and aquifer permeability k . The equations given in figures 4-15 and 4-16 consider these variables.

(2) Flow to wells from a line source,

(a) Equations given in figures 4-17 through 4-19 for flow and drawdown produced by pumping a single well or group of fully penetrating wells supplied from an infinite line source were developed using the method of image wells. The image well (a recharge well) is located as the mirror image of the real well with respect to the line source and supplies the pervious stratum with the same quantity of water as that being pumped from the real well.

(b) The equations given in figures 4-18 and 4-19 for multiple-well systems supplied by a line source are based on the fact that the drawdown at any point is the summation of drawdowns produced at that point by each well in the system. Consequently, the drawdown at a point is the sum of the drawdowns produced by the real wells and the negative drawdowns produced by the image or recharge wells.

(c) Equations are given in figures 4-20 through 4-22 for flow and drawdown produced by pumping an infinite line at wells supplied by a (*single*) *line source*. The equations are based on the equivalent slot assumption. Where twice the distance to a *single* line source or $2L$ is greater than the radius of influence R , the value of R as determined from a pumping test or from figure 4-23 should be used in lieu of L unless the excavation is quite large or the tunnel is long, in which case equations for a line source or a flow-net analysis should be used.

(d) Equations for computing the head midway between wells above that in the wells Δh_m are not given in this manual for *two* line sources adjacent to a single line of wells. However, such can be readily determined from (plan) flow-net analyses.

(3) *Limitations on flow to a partially penetrating well.* Theoretical boundaries for a partially penetrating well (for artesian flow) are approximate relations intended to present in a simple form the results of more rigorous but tedious computations. The rigorous computations were made for ratios of $R/D = 4.0$ and 6.7 and a ratio $R/r_w = 1000$. As a consequence, any agreement between experimental and computed values cannot be expected except for the cases with these particular boundary conditions. In model studies at the U.S. Army Engineer Waterways Experiment Station (WES), Vicksburg, Mississippi, the flow from a partially penetrating well was based on the formula:

$$Q_{wp} = \frac{2\pi kD(H - h_w)G}{\ln(R/r_w)} \quad (4-2)$$

or

$$Q_{wp} = kD(H - h_w)\mathfrak{f} \quad (4-2a)$$

with

$$\mathfrak{f} = \frac{2\pi G}{\ln(R/r_w)}$$

where

G = quantity shown in equation (6), figure 4-10

\mathfrak{f} = geometric shape factor

Figure 4-26 shows some of the results obtained at the WES for \mathfrak{f} for wells of various penetrations centered inside a circular source. Also presented in figure 4-26 are boundary curves computed for well-screen penetrations of 2 and 50 percent. Comparison of \mathfrak{f} computed from WES model data with \mathfrak{f} computed from the boundary formulas indicates fairly good agreement for well penetrations > 25 percent and values of R/D between about 5 and 15 where R/r_w 1 200 to 1000. Other empirical formulas for flow from a partially penetrating well suffer from the same limitations.

(4) *Partially penetrating wells.* The equations for *gravity flow* to *partially* penetrating wells are only considered valid for relatively high-percent penetrations.

4-3. Flow-net analyses.

a. Flow nets are valuable where irregular configurations of the source of seepage or of the dewatering system make mathematical analyses complex or impossible. However, considerable practice in drawing and studying good flow nets is required before accurate flow nets can be constructed.

b. A flow net is a graphical representation of flow of water through an aquifer and defines paths of seepage (flow lines) and contours of equal piezometric head (equipotential lines). A flow net may be constructed to represent either a plan or a section view of a seepage pattern. Before a sectional flow net can be constructed, boundary conditions affecting the flow pattern must be delineated and the pervious formation transformed into one where $k_n = k_v$ (app E). In drawing a flow net, the following general rules must be observed:

(1) Flow lines and equipotential lines intersect at right angles and form curvilinear squares or rectangles.

(2) The flow between any two adjacent flow lines and the head loss between any two adjacent equipotential lines are equal, except where the plan or section cannot be divided conveniently into squares, in which case a row of rectangles will remain with the ratio of the lengths to the sides being constant.

(3) A drainage surface exposed to air is neither an equipotential nor flow line, and the squares at this surface are incomplete; the flow and equipotential lines need not intersect such a boundary at right angles.

(4) For gravity flow, equipotential lines intersect the phreatic surface at equal intervals of elevation, each interval being a constant fraction of the total net head.

c. Flow nets are limited to analysis in two dimensions; the third dimension in each case is assumed infinite in extent. An example of a sectional flow net showing artesian flow from two line sources to a partially penetrating drainage slot is given in figure 4-27a. An example of a plan flow net showing artesian flow from a river to a line of relief wells is shown in figure 4-27b.

d. The flow per unit length (for sectional flow nets) or depth (for plan flow nets) can be computed by means of equations (1) and (2), and (5) and (6), respectively (fig. 4-27). Drawdowns from either sectional or plan flow nets can be computed from equations (3) and (4) (fig. 4-27). In plan flow nets for artesian flow, the equipotential lines correspond to various values of $H-h$, whereas for gravity flow, they correspond to H^2-h^2 . Since section equipotential lines for gravity flow conditions are curved rather than vertical, plan flow nets for gravity flow conditions give erroneous results for large drawdowns and should always be used with caution.

e. Plan flow nets give erroneous results if used to analyze partially penetrating drainage systems, the error being inversely proportional to the percentage of penetration. They give fairly accurate results if the penetration of the drainage system exceeds 80 percent and if the heads are adjusted as described in the following paragraph.

f. In previous analyses of well systems by means of flow nets, it was assumed that dewatering or drainage wells were spaced sufficiently close to be simulated by a continuous drainage slot and that the drawdown ($H-h_D$) required to dewater an area equaled the average drawdown at the drainage slot or in the lines of wells ($H-h_e$). These analyses give the amount of flow Q_T that must be pumped to achieve $H-h_D$ but do not give the drawdown at the wells. The drawdown at the wells required to produce $H-h_D$ downstream or within a ring of wells can be computed (approximately) for artesian flow from plan flow nets by the equations shown in figure 4-28 if the wells have been spaced proportional to the flow lines as shown in figure 4-27. The drawdown at fully penetrating gravity wells can also be computed from equations given in figure 4-28.

4-4. Electrical analogy seepage models.

a. The laws governing flow of fluids through porous media and flow of electricity through pure resistance are mathematically similar. Thus, it is feasible to use electrical models to study seepage flows and pressure

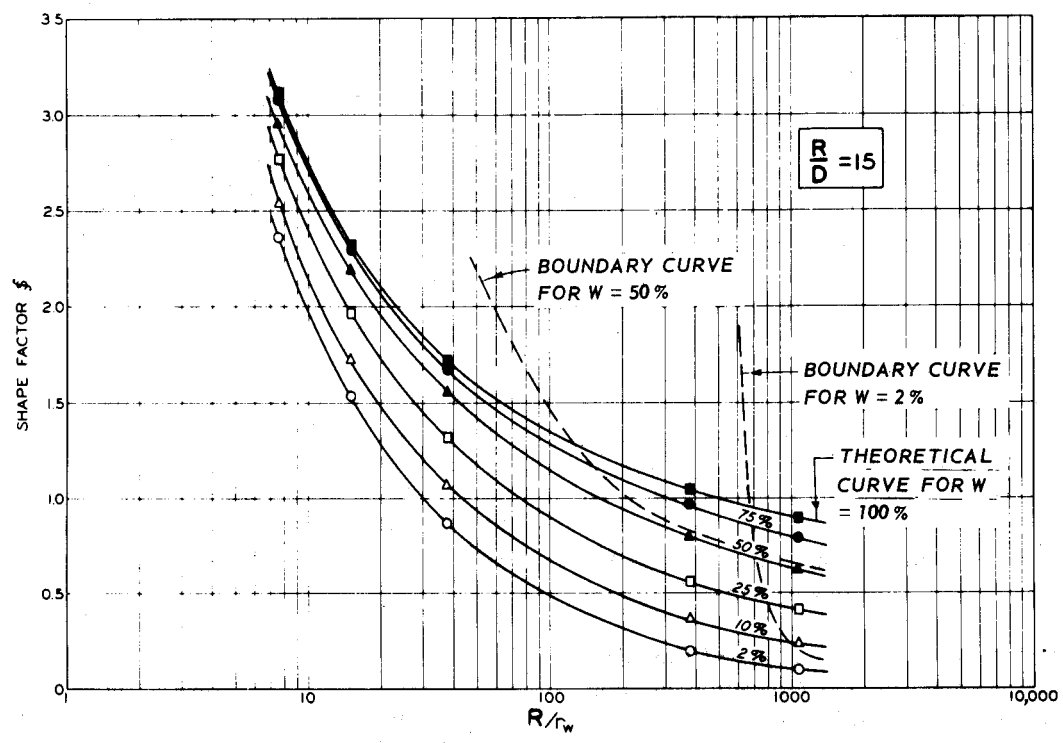
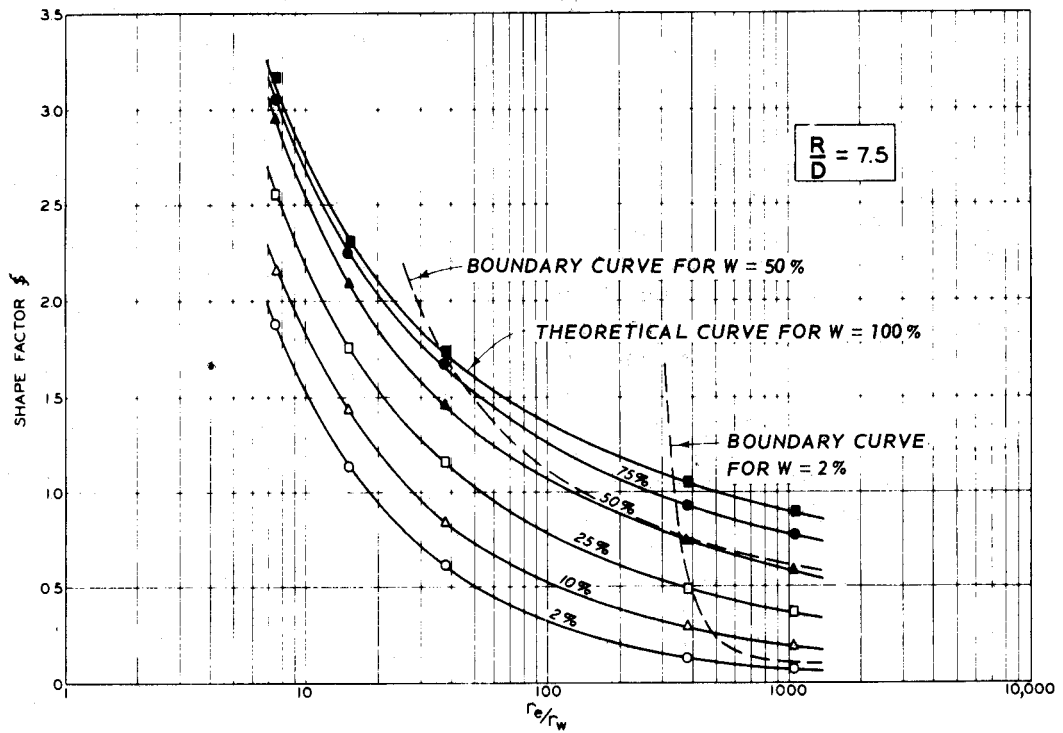

NOTE: BOTTOM OF ALL WELLS SEALED (I.E. INSULATED IN MODEL).

U.S. Army Corps of Engineers

Figure 4-26. Shape factors for wells of various penetrations centered inside a circular source.

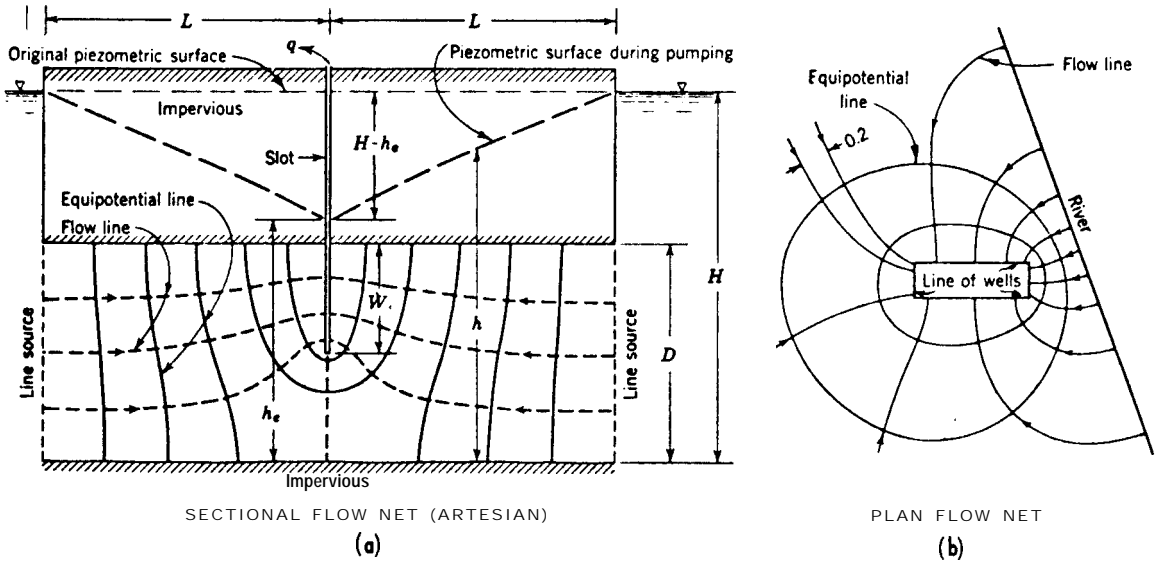

SECTIONAL FLOW NET

FLOW

ARTESIAN $q = kH' \mathcal{F}$ (1)

GRAVITY $q = kH'' \mathcal{F}$ (2)

DRAWDOWN AT ANY POINT

ARTESIAN $H - h = H' \frac{n_e}{N_e}$ (3)

GRAVITY $H^2 - h^2 = \frac{n_e}{N_e} [H^2 - (h_o + h_s)^2]$ (4)

PLAN FLOW NET

FLOW

ARTESIAN $Q_T = kDH' \mathcal{F}$ (5)

GRAVITY $Q_T = \frac{kH'' \mathcal{F}}{2}$ (6)

DRAWDOWN AT ANY POINT

USE EQ 3 AND 4, FOR ARTESIAN AND GRAVITY FLOW CONDITIONS, RESPECTIVELY.

$H' = H - h_e$ $H'' = H^2 - h_o^2$ $\mathcal{F} = \text{SHAPE FACTOR} = \frac{N_f}{N_e}$ $N_f = \text{NUMBER OF FLOW CHANNELS IN NET}$

$N_e = \text{TOTAL NUMBER OF EQUIPOTENTIAL DROPS BETWEEN FULL HEAD, } H, \text{ AND HEAD AT EXIT, } h_e$

$n_e = \text{NUMBER OF EQUIPOTENTIAL DROPS FROM EXIT TO POINT AT WHICH HEAD, } h, \text{ IS DESIRED}$

h_o IS SHOWN IN FIG. 4-1

SEE FIG. 4-29 FOR HEAD CORRECTION FACTORS,

(Modified from "Foundation Engineering," G. A. Leonards, ed., 1962, McGraw-Hill Book Company. Used with permission of McGraw-Hill Book Company.)

Figure 4-27. Flow and drawdown to slots computed from flow nets.

distribution for various seepage conditions. Both two- and three-dimensional models can be used to solve seepage problems.

b. Darcy's law for two-dimensional flow of water

(previously identified as equation (1) in fig. 4-27) through soil can be expressed for unit length of soil formations as follows:

$q = kH' \mathcal{F}$ (4-3)

CONSTRUCT PLAN FLOW NET. SPACE WELLS PROPORTIONAL TO FLOW LINES. COMPUTE TOTAL FLOW TO SYSTEM FROM EQ 5 FOR ARTESIAN FLOW OR EQ 6 FOR GRAVITY FLOW (FIG. 4-28), ASSUME IN EQ 5 $H' = H - h_D$. SEE FIG. 4-20, b, c; 4-22, b; AND 4-26 FOR EXPLANATION OF TERMS.

ARTESIAN FLOW

FLOW TO EACH WELL

$$Q_w = \frac{Q_T}{n} \tag{1}$$

WHERE n = NUMBER OF WELLS IN THE SYSTEM

DRAWDOWN AT WELLS

FULLY PENETRATING

$$H - h_w = \frac{Q_w}{kD} \left(\frac{n}{\mathcal{F}} + \frac{1}{2\pi} \ln \frac{a}{2\pi r_w} \right) \tag{2}$$

PARTIALLY PENETRATING

$$H - h_w = \frac{Q_w}{kD} \left(\frac{n}{\mathcal{F}} + \theta_a \right) \tag{3}$$

WHERE θ_a IS OBTAINED FROM FIG. 4-21 †

HEAD INCREASES MIDWAY BETWEEN AND DOWNSTREAM OF WELLS MAY BE COMPUTED FROM EQUATIONS GIVEN IN FIG. 4-20 AND 4-21.

GRAVITY FLOW

FLOW TO EACH WELL

USE EQ 1

DRAWDOWN AT FULLY PENETRATING WELL

$$H^2 - h_w^2 = \frac{Q_w}{k} \left(\frac{n}{\mathcal{F}} + \frac{1}{\pi} \ln \frac{a}{\pi r_w} \right) \tag{4}$$

HEAD INCREASES MIDWAY BETWEEN AND DOWNSTREAM OF WELLS MAY BE COMPUTED FROM EQUATIONS GIVEN IN FIG. 4-22.

† THE AVERAGE WELL SPACING MAY BE USED TO COMPUTE θ_a, θ_m , AND THE DRAWDOWN AT AND BETWEEN WELLS.

U. S. Army Corps of Engineers

Figure 4-28. Flow and drawdown to wells computed from flow-net analyses

where

- q = rate of flow
- k = coefficient of permeability
- H' = differential head
- \mathcal{F} = shape factor dependent on the geometry of the system

c. Ohm's law expresses the analogous condition for steady flow of electricity through a medium of pure re-

sistance as follows:

$$I = \frac{E}{\rho} \tag{4-4}$$

where

- I = rate of flow of electricity
- E = potential difference or voltage
- ρ = specific resistance of electrolyte

Since the permeability in fluid flow is analogous to the reciprocal of the specific resistance for geometrically similar mediums, the shape factors for Darcy's law and Ohm's law are the same.

d. A two-dimensional flow net can be constructed using a scale model of the flow and drainage system made of a conductive material representing the porous media (graphite-treated paper or an electrolytic solution), copper or silver strips for source of seepage and drainage, and nonconductive material representing impervious flow boundaries. The electrical circuit consists of a potential applied across the model and a Wheatstone bridge to control intermediate potentials on the model (fig. 4-29). The flow net is constructed by tracing lines of constant potential on the model, thus establishing the flow-net equipotential lines after which the flow lines are easily added graphically. A

flow net constructed using an electrical analogy model may be analyzed in the same manner as one constructed as in paragraph 4-3.

e. Equipment for conducting three-dimensional electrical analogy model studies is available at the WES. The equipment consists basically of a large plexiglass tank filled with diluted copper sulfate solution and having a calibrated, elevated carrier assembly for the accurate positioning of a point electrode probe anywhere in the fluid medium. A prototype is simulated by fabricating appropriately shaped and sealed source and sink configurations and applying an electrical potential across them. The model is particularly useful for analyzing complex boundary conditions that cannot be readily analyzed by two-dimensional techniques.

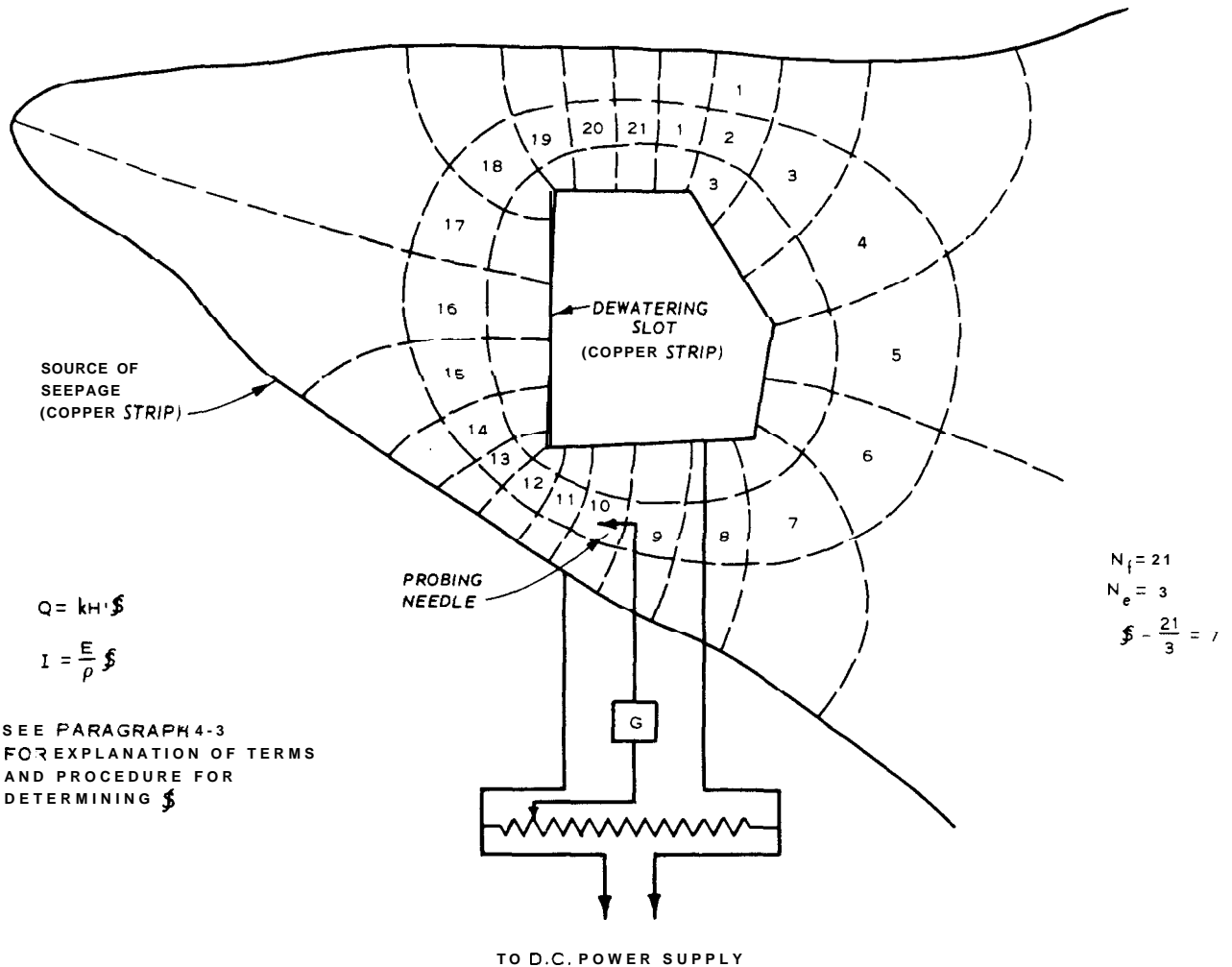

U. S. Army Corps of Engineers

(Fruco & Associates, Inc.)

Figure 4-29. Diagrammatic layout of electrical analogy model.

4-5. Numerical analyses.

a. Many complex seepage problems, including such categories as steady confined, steady unconfined, and transient unconfined can be solved using the finite element method. Various computer codes are available at the WES and the NAVFAC program library to handle a variety of two- and three-dimensional seepage problems. The codes can handle most cases of nonhomogeneous and anisotropic media.

b. A general computer code for analyzing partially penetrating random well arrays has been developed based on results of three-dimensional electrical analogy model tests at the WES. The computer code provides a means for rapidly analyzing trial well systems in which the number of wells and their geometric configuration can be varied to determine quantities of seepage and head distributions. Wells of different radii and penetrations can be considered in the analysis.

4-6. **Wellpoints**, wells, and filters. Wells and wellpoints should be of a type that will prevent infiltration of filter material or foundation sand, offer little resistance to the inflow of water, and resist corrosion by water and soil. Wellpoints must also have sufficient penetration of the principal water-carrying strata to intercept seepage without excessive residual head between the wells or within the dewatered area.

a. **Wellpoints.** Where large flows are anticipated, a high-capacity type of wellpoint should be selected. The inner suction pipe of self-jetting wellpoints should permit inflow of water with a minimum hydraulic head loss. Self-jetting wellpoints should be designed so that most of the jet water will go out the tip of the point, with some backflow to keep the screen flushed clean while jetting the wellpoint in place.

(1) **Wellpoint screens.** Generally, wellpoints are covered with 30- to 60-mesh screen or have an equivalent slot opening (0.010 to 0.025 inch). The mesh should meet filter criteria given in c below. Where the soil to be drained is silty or fine sand, the yield of the wellpoint and its efficiency can be greatly improved by placing a relatively uniform, medium sand filter around the wellpoint. The filter should be designed in accordance with criteria subsequently set forth in c below. A filter will permit the use of screens or slots with larger openings and provide a more pervious material around the wellpoint, thereby increasing its effective radius (d below).

(2) **Wellpoint hydraulics.** The hydraulic head losses in a wellpoint system must be considered in designing a dewatering system. These losses can be estimated from figure 4-25.

b. **Wells.** Wells for temporary dewatering and permanent drainage systems may have diameters ranging

from 4 to 18 inches with a screen 20 to 75 feet long depending on the flow and pump size requirements.

(1) **Well screens.** Screens generally used for dewatering wells are slotted (or perforated) steel pipe, perforated steel pipe wrapped with galvanized wire, galvanized wire wrapped and welded to longitudinal rods, and slotted polyvinyl chloride (PVC) pipe. Riser pipes for most dewatering wells consist of steel or PVC pipe. Screens and riser for permanent wells are usually made of stainless steel or PVC. Good practice dictates the use of a filter around dewatering wells, which permits the use of fairly large slots or perforations, usually 0.025 to 0.100 inch in size. The slots in well screens should be as wide as possible but should meet criteria given in c below.

(2) **Open screen area.** The open area of a well screen should be sufficient to keep the entrance velocity for the design flow low to reduce head losses and to minimize incrustation of the well screen in certain types of water. For temporary dewatering wells installed in nonincrusting groundwater, the entrance velocity should not exceed about 0.15 to 0.20 foot per second; for incrusting groundwater, the entrance velocity should not exceed 0.10 to 0.20 foot per second. For permanent drainage wells, the entrance velocity should not exceed about 0.10 foot per second. As the flow to and length of a well screen is usually dictated by the characteristics of the aquifer and drawdown requirements, the required open screen area can be obtained by using a screen of appropriate diameter with a maximum amount of open screen area.

(3) **Well hydraulics.** Head losses within the well system discussed in paragraph 4-2a(5) can be estimated from figure 4-24.

c. **Filters.** Filters are usually 3 to 5 inches thick for wellpoints and 6 to 8 inches thick for large-diameter wells (fig. 4-30). To prevent infiltration of the aquifer materials into the filter and of filter materials into the well or wellpoint, without excessive head losses, filters should meet the following criteria:

Screen-filter criteria

Slot or screen openings \leq minimum filter D_{50}

Filter-aquifer criteria

$$\frac{\text{Max filter } D_{15}}{\text{Min aquifer } D_{85}} \leq 5; \quad \frac{\text{Max filter } D_{50}}{\text{Min aquifer } D_{50}} \leq 25;$$

$$\frac{\text{Min filter } D_{15}}{\text{Max aquifer } D_{15}} \geq 2 \text{ to } 5$$

If the filter is to be tremied in around the screen for a well or wellpoint, it may be either uniformly or rather widely graded; however, if the filter is not tremied into place, it should be quite uniformly graded ($D_{90}/D_{10} \leq 3$ to 4) and poured in around the well in a heavy, continuous stream to minimize segregation.

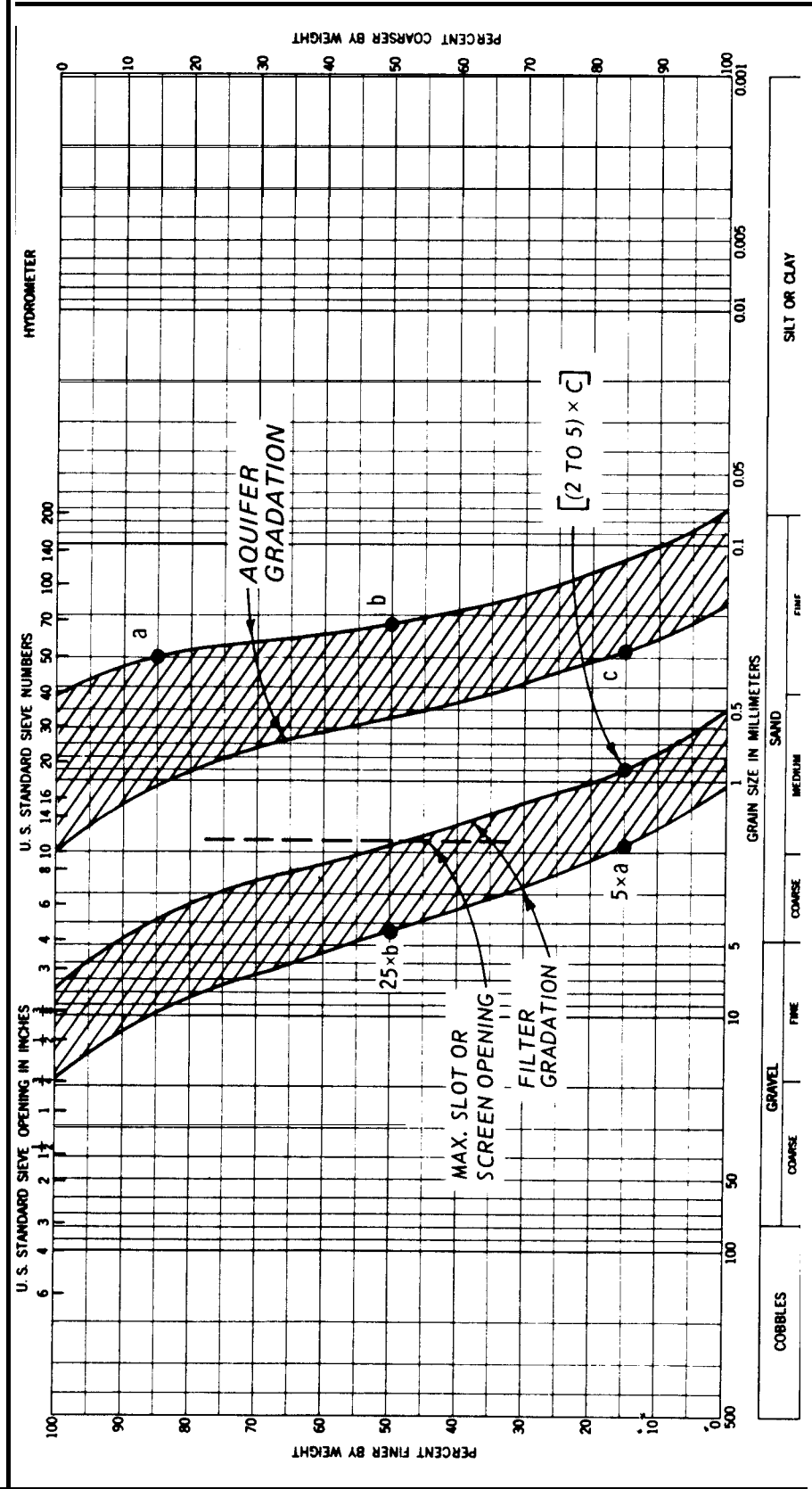

U.S. Army Corps of Engineers

Figure 4-30. Typical design of a filter for a well or wellpoint.

d. *Effective well radius.* The “effective” radius r_w of a well is that well radius which would have no hydraulic entrance loss H_w . If well entrance losses are considered separately in the design of a well or system of wells, r_w for a well or wellpoint without a filter may be considered to be one-half the outside diameter of the well screens; where a filter has been placed around a wellpoint or well screen, r_w may generally be considered to be one-half the outside diameter or the radius of the filter.

e. *Well penetration.* In a stratified aquifer, the effective well penetration usually differs from that computed from the ratio of the length of well screen to total thickness of the aquifer. A method for determining the required length of well screen W to achieve an effective penetration \bar{W} in a stratified aquifer is given in appendix E.

f. *Screen length, penetration, and diameter.* The length and penetration of the screen depends on the thickness and stratification of the strata to be dewatered (para 4-2a(6)). The length and diameter of the screen and the area of perforations should be sufficient to permit the inflow of water without exceeding the entrance velocity given in b(2) above. The “wetted screen length h_{ws} ” (or h_w for each stratum to be dewatered) is equal to or greater than Q_w/q_c (para 4-2a(4) and (6)). The diameter of the well screen should be at least 3 to 4 inches larger than the pump bowl or motor.

4-7. Pumps, headers, and discharge pipes. The capacity of pumps and piping should allow for possible reduction in efficiency because of in-

crustation or mechanical wear caused by prolonged operation. This equipment should also be designed with appropriate valves, crossovers, and standby units so that the system can operate continuously, regardless of interruption for routine maintenance or breakdown.

a. *Centrifugal and wellpoint pumps.*

(1) Centrifugal pumps can be used as sump pumps, jet pumps, or in combination with an auxiliary vacuum pump as a wellpoint pump. The selection of a pump and power unit depends on the discharge, suction lift, hydraulic head losses, including velocity head and discharge head, air-handling requirement, power available, fuel economy, and durability of unit. A wellpoint pump, consisting of a self-priming centrifugal pump with an attached auxiliary vacuum pump, should have adequate air-handling capacity and be capable of producing a vacuum of at least 22 to 25 feet of water in the headers. The suction lift of a wellpoint pump is dependent on the vacuum available at the pump bowl, and the required vacuum must be considered in determining the pumping capacity of the pump. Characteristics of a typical 8-inch wellpoint pump are shown in figure 4-31. Characteristics of a typical wellpoint pump vacuum unit are shown in figure 4-32. Sump pumps of the centrifugal type should be self-priming and capable of developing at least 20 feet of vacuum. Jet pumps are high head pumps; typical characteristics of a typical 6-inch jet pump are shown in figure 4-33.

(2) Each wellpoint pump should be provided with one *connected* standby pump so as to ensure continuity

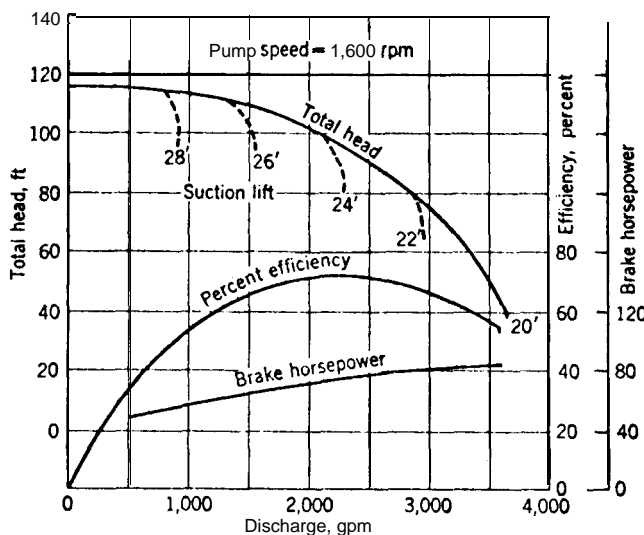

(Courtesy of Griffin Wellpoint Corp. and “Foundation Engineering,” McGraw Hill Book Company)

Figure 4-31. Characteristics of 8-inch Griffin wellpoint pump.

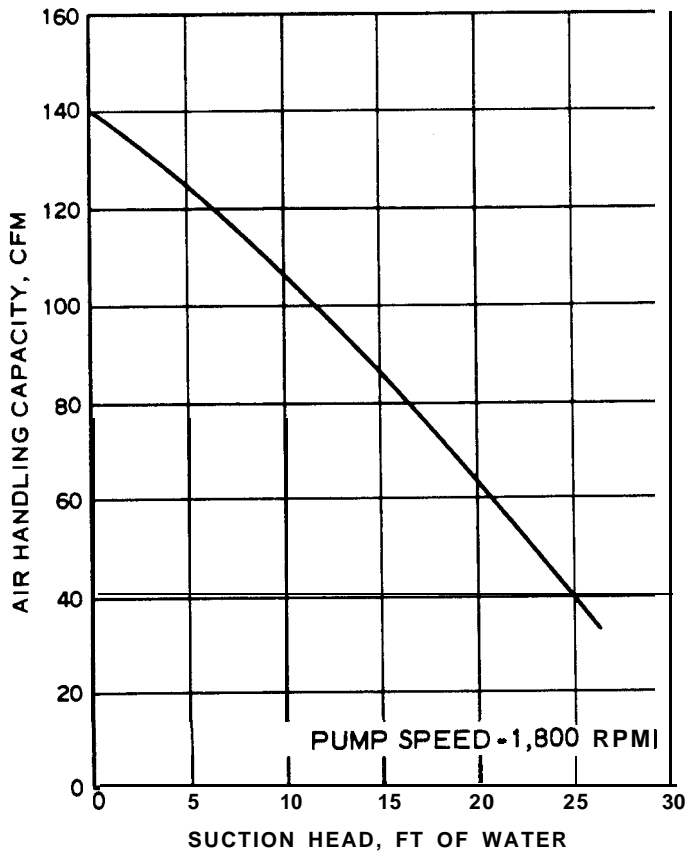

U. S. Army Corps of Engineers

Figure 4-32. Characteristics of typical vacuum unit for wellpoint pumps

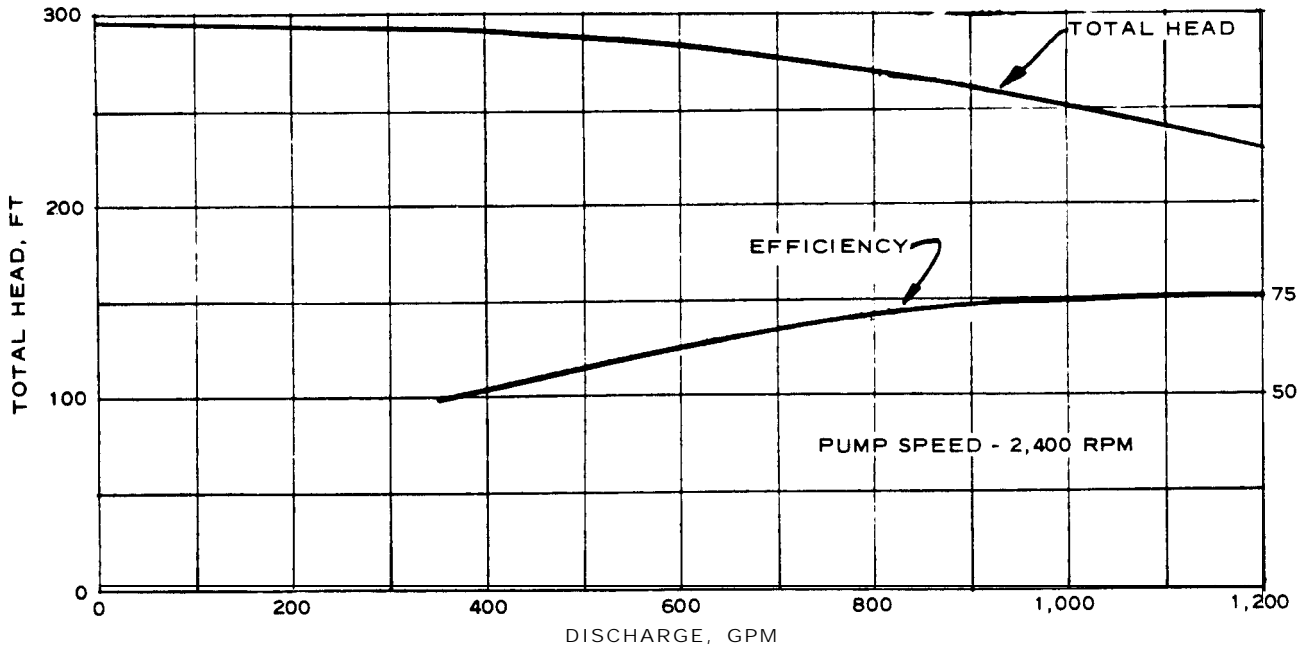

U. S. Army Corps of Engineers

Figure 4-33. Characteristics of 6-inch jet pump.

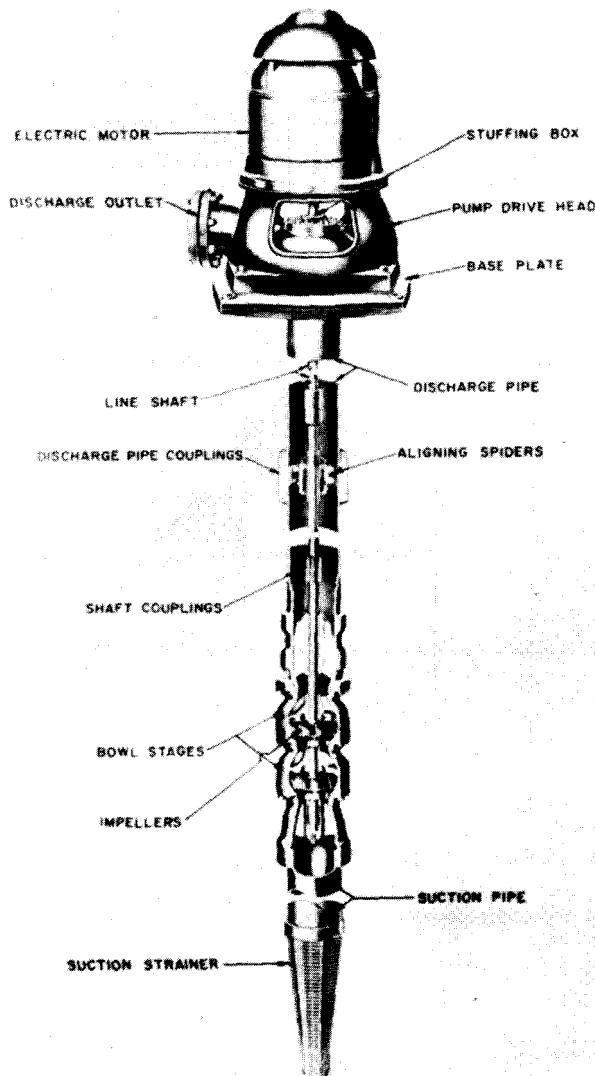

(Courtesy of Layne & Bowler, Inc., Memphis, Tenn.)

Figure 4-34. Deep-well turbine pump.

of operation in event of pump or engine failure, or for repair or maintenance. By overdesigning the header pipe system and proper placement of valves, it may be possible to install only one standby pump for every two operational pumps. If electric motors are used for powering the normally operating pumps, the standby pumps should be powered with diesel, natural or LP gas, or gasoline engines. The type of power selected will depend on the power facilities at the site and the economics of installation, operation, and maintenance. It is also advisable to have spare power units on site in addition to the standby pumping units. Automatic switches, starters, and valves may be required if failure of the system is critical.

b. Deep-well pumps.

(1) Deep-well turbine or submersible pumps are generally used to pump large-diameter deep wells and consist of one or more stages of impellers on a vertical shaft (fig. 4-34). Turbine pumps can also be used as sump pumps, but adequate stilling basins and trash racks are required to assure that the pumps do not become clogged. Motors of most large-capacity turbine pumps used in deep wells are mounted at the ground surface. Submersible pumps are usually used for pumping deep, low-capacity wells, particularly if a vacuum is required in the well.

(2) In the design of deep-well pumps, consideration must be given to required capacity, size of well

Table 4-2. Capacity of Various Size Submersible and Deep-Well Turbine Pumps

Maximum Pump Bowl or Motor Size inches	Inside Diameter of Well inches	Approximate Maximum Capacity gallons per minute	
		Deep Well	Submersible
4	5-6	90	70
5	6-8	160	--
6	8-10	450	250
8	10-12	600	400
10	12-14	1,200	700
12	14-16	1,800	1,100
14	16-18	2,400	--
16	18-20	3,000	--

U. S. Army Corps of Engineers

screen and riser pipe, total pumping head, and the lowered elevation of the water in the well. The diameter of the pump bowl must be determined before the wells are installed, as the inside diameter of the well casing should be at least 3 to 4 inches larger in diameter than the pump bowl. Approximate capacities of various turbine pumps are presented in table 4-2. The characteristics of a typical three-stage, 10-inch turbine pump are shown in figure 4-35.

(3) Submersible pumps require either electric power from a commercial source or one or more motor generators. If commercial power is used, 75 to 100 percent of (connected) motor generator power, with automatic starters unless operational personnel are on duty at all times, should be provided as standby for the commercial power. Spare submersible pumps, generally 10 to 20 percent of the number of operating pumps, as well as spare starters, switches, heaters, and fuses, should also be kept at the site.

(4) Deep-well turbine pumps can be powered with either electric motors or diesel engines and gear drives. Where electric motors are used, 50 to 100 percent of the pumps should be equipped with combination gear drives connected to diesel (standby) engines. The number of pumps so equipped would depend upon the criticality of the dewatering or pressure relief needs. Motor generators may also be used as standby for commercial power. For some excavations and subsurface conditions, automatic starters may be required for the diesel engines or motor generators being used as backup for commercial power.

c. *Turbovacuum pumps.* For some wellpoint systems requiring high pumping rates, it may be desirable

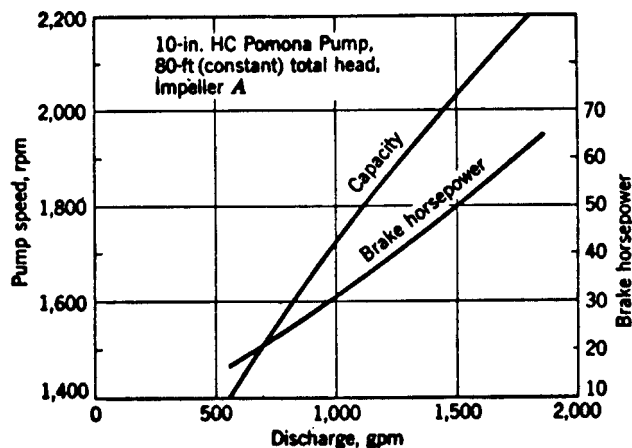

(Courtesy of Fairbanks Morse, Inc., Pump Division)

Figure 4-35. Rating curves for a three-stage 10-inch-high capacity deep-well pump.

to connect the header pipe to a 30- or 36-inch collection tank about 20 or 30 feet deep, sealed at the bottom and top, and pump the flow into the tank with a high-capacity deepwell turbine pump using a separate vacuum pump connected to the top of the tank to produce the necessary vacuum in the header pipe for the wells or wellpoints.

d. *Header pipe.*

(1) Hydraulic head losses caused by flow through the header pipe, reducers, tees, fittings, and valves should be computed and kept to a minimum (1 to 3 feet) by using large enough pipe. These losses can be computed from equivalent pipe lengths for various fittings and curves.

(2) Wellpoint header pipes should be installed as close as practical to the prevailing groundwater elevation and in accessible locations. Wellpoint pumps should be centrally located so that head losses to the ends of the system are balanced and as low as possible. If suction lift is critical, the pump should be placed low enough so that the pump suction is level with the header, thereby achieving a maximum vacuum in the header and the wellpoints. If construction is to be performed in stages, sufficient valves should be provided in the header to permit addition or removal of portions of the system without interrupting operation of the remainder of the system. Valves should also be located to permit isolation of a portion of the system in case construction operations should break a swing connection or rupture a header.

(3) Discharge lines should be sized so that the head losses do not create excessive back pressure on the pump. Ditches may be used to carry the water from the construction site, but they should be located well back of the excavation and should be reasonably watertight.

4-8. Factors of safety.

a. General. The stability of soil in areas of seepage emergence is critical in the control of seepage. The exit gradient at the toe of a slope or in the bottom of an excavation must not exceed that which will cause surface raveling or sloughing of the slope, piping, or heave of the bottom of the excavation.

b. Uplift. Before attempting to control seepage, an analysis should be made to ensure that the seepage or uplift gradient is equal to or less than that computed from the following equations:

$$i \leq \frac{\gamma'_m}{\gamma_w \text{ (FS = 1.25 to 1.5)}} \quad (4-5)$$

or

$$Ah = \frac{(\gamma'_m)^T}{\gamma_w \text{ (FS = 1.25 to 1.5)}} \quad (4-6)$$

where

- i = seepage gradient $\Delta h/L$
- γ'_m = submerged unit weight of soil
- γ_w = unit weight of water
- Δh = artesian head above bottom of slope or excavation
- T = thickness of less pervious strata overlying a more pervious stratum
- L = distance through which Ah acts

In stratified subsurface soils, such as a coarse-grained pervious stratum overlain by a finer grained stratum of relatively low permeability, most of the head loss through the entire section would probably occur through the finer grained material. Consequently, a factor of safety based on the head loss through the top stratum would probably indicate a more critical condition than if the factor of safety was computed from the total head loss through the entire section. Also, when gradients in anisotropic soils are determined from flow nets, the distance over which the head is lost must be obtained from the true section rather than the transformed section.

c. Piping. Piping cannot be analyzed by any rational method. In a study of piping beneath hydraulic structures founded on granular soils, it was recommended that the (weighted) creep ratio C_w should equal or exceed the values shown in table 4-3 for various types of granular soils,

$$C_w = \frac{\text{I vertical seepage paths} + 1/3 \text{ I horizontal seepage paths}}{H - h_e} \quad (4-7)$$

Table 4-3. Minimum Creep Ratios for Various Granular Soils

Soil	Creep Ratio
Very fine sand or silt	8.5
Fine sand	7
Medium sand	6
Coarse sand	5
Fine gravel	4
Medium gravel	3.5
Coarse gravel including cobbles	3
Boulders with some cobbles and gravel	2.5

From "Security from Under-Seepage Masonry Dams," by E.W. Lane, pp. 1235-1272. Transactions, American Society of Civil Engineers, 1935.

where $H - h_e$ represents vertical distance from the groundwater table to the bottom of the excavation. These criteria for piping are probably only applicable to dewatering of sheeted, cellular, or earth-dike cofferdams founded on granular soils. Once piping develops, erosion of the soil may accelerate rapidly. As the length of seepage flow is reduced, the hydraulic gradient and seepage velocity increase, with a resultant acceleration in piping and erosion. Piping can be controlled by lowering the groundwater table in the excavated slopes or bottom of an excavation, or in either less critical situations or emergencies by placement of filters over the seepage exit surface to prevent erosion of the soil but still permit free flow of the seepage. The gradation of the filter material should be such that the permeability is high compared with the aquifer, yet fine enough that aquifer materials will not migrate into or through the filter. The filter should be designed on the basis of criteria given in paragraph 4-6c. More than one layer of filter material may be required to stabilize a seeping slope or bottom of an excavation in order to meet these criteria.

d. *Dewatering systems.* As in the design of any works, the design of a dewatering system should include a factor of safety to cover the variations in char-

acteristics of the subsurface soils, stratification, and groundwater table; the incompleteness of the data and accuracy of the formulations on which the design is based; the reduction in the efficiency of the dewatering system with time; the frailties of machines and operating personnel; and the criticality of failure of the system with regard to safety, economics, and damage to the project. All of these factors should be considered in selecting the factor of safety. The less information on which the design is based and the more critical the dewatering is to the success of the project, the higher the required factor of safety. Suggested factors of safety and design procedures are as follows:

- (1) Select or determine the design parameters as accurately as possible from existing information.
- (2) Use applicable design procedures and equations set forth in this manual.
- (3) Consider the above enumerated factors in selecting a factor of safety.
- (4) Evaluate the experience of the designer.
- (5) After having considered steps 1-4, the following factors of safety are considered appropriate for modifying computed design values for flow, drawdown, well spacing, and required "wetted screen length."

Factor of Safety for Design (FS = 1.0 + (a + b + c))

	Factor to be Added to 1.0
(a) <i>Design Data</i>	
Poor	0.25
Fair	0.20
Good	0.10
Excellent	0.05
(b) <i>Experience of Designer</i>	
Little	0.25
Some	0.20
Good	0.10
Excellent	0.05
(c) <i>Criticality</i>	
Great	0.25
Moderate	0.20
Little	0.15

Application of Factor of Safety to Computed Values or System Design Features

Computed Value System Design Feature	Design Procedure	Remarks
Pump capacity, header, and discharge pipe (Q)	Increase Q to FS
Drawdown (Δh)	Decrease Δh by 10 percent	} Adjust either drawdown or well spacing, but not both
Well spacing (a)	Decrease a by 10 percent	
Wetted screen length (h_{ws})	h_{ws}

Note: In initially computing drawdown, well spacing, and wetted screen, use flow and other parameters unadjusted for factor of safety.

In addition to these factors of safety being applied to design features of the system, the system should be pump-tested to verify its adequacy for the maximum required groundwater lowering and maximum river or groundwater table likely (normally a frequency of occurrence of once in 5 to 10 years for the period of exposure) to occur.

4-9. Dewatering open excavations. An excavation can be dewatered or the artesian pressure relieved by one or a combination of methods described in chapter 2. The design of dewatering and groundwater control systems for open excavations, shafts, and tunnels is discussed in the following paragraphs. Examples of design for various types of dewatering and pressure relief systems are given in appendix D.

a. *Trenching and sump pumping.*

(1) The applicability of trenches and sump pumping for dewatering an open excavation is discussed in chapter 2. Where soil conditions and the depth of an excavation below the water table permit trenching and sump pumping of seepage (fig. 2-1), the rate of flow into the excavation can be estimated from plan and sectional flow analyses (fig. 4-27) or formulas presented in paragraphs 4-2 through 4-5.

(2) Where an excavation extends into rock and there is a substantial inflow of seepage, perimeter drains can be installed at the foundation level outside of the formwork for a structure. The perimeter drainage system should be connected to a sump sealed off from the rest of the area to be concreted, and the seepage water pumped out. After construction, the drainage system should be grouted. Excessive hydrostatic pressures in the rock mass endangering the stability of the excavated face can be relieved by drilling 4-inch-diameter horizontal drain holes into the rock at approximately 10-foot centers. For large seepage inflow, supplementary vertical holes for deep-well pumps at 50- to 100-foot intervals may be desirable for temporary lowering of the groundwater level to provide suitable conditions for concrete placement.

b. *Wellpoint system.* The design of a line or ring of wellpoints pumped with either a conventional wellpoint pump or jet-eductors is generally based on mathematical or flow-net analysis of flow and drawdown to a continuous slot (para 4-2 through 4-5).

(1) *Conventional wellpoint system.* The drawdown attainable per stage of wellpoints (about 15 feet) is limited by the vacuum that can be developed by the pump, the height of the pump above the header pipe, and hydraulic head losses in the wellpoint and collector system. Where two or more stages of wellpoints are required, it is customary to design each stage so that it is capable of producing the total drawdown required by that stage with none of the upper stages functioning. However, the upper stages are generally left in so

that they can be pumped in the event pumping of the bottom stage of wellpoints does not lower the water table below the excavation slope because of stratification, and so that they can be pumped during backfilling operations.

(a) The design of a conventional wellpoint system to dewater an open excavation, as discussed in paragraph 4-2b, is outlined below.

Step 1. Select dimensions and groundwater coefficients (H, L, and k) of the formation to be dewatered based on investigations outlined in chapter 3.

Step 2. Determine the drawdown required to dewater the excavation or to dewater down to the next stage of wellpoints, based on the maximum groundwater level expected during the period of operation.

Step 3. Compute the head at the assumed slot (h_e or h_o) to produce the desired residual head h_D in the excavation.

Step 4. Compute the flow per lineal foot of drainage system to the slot Q_p .

Step 5. Assume a wellpoint spacing a and compute the flow per wellpoint, $Q_w = aQ_p$.

Step 6. Calculate the required head at the wellpoint h_w corresponding to Q_w .

Step 7. Check to see if the suction lift that can be produced by the wellpoint pump V will lower the water level in the wellpoint to $h_w(p)$ as follows:

$$V \geq M - h_w(p) + H_c + H_w \quad (4-8)$$

where

v = vacuum at pump intake, feet of water

M = distance from base of pervious strata to pump intake, feet

H_c = average head loss in header pipe from wellpoint, feet

H_w = head loss in wellpoint, riser pipe, and swing connection to header pipe, feet

Step 8. Set the top of the wellpoint screen at least 1 to 2 feet or more below $h_w - H_w$ to provide adequate submergence of the wellpoint so that air will not be pulled into the system.

(b) An example of the design of a two-stage wellpoint system to dewater an excavation is illustrated in figure D-1, appendix D.

(c) If an excavation extends below an aquifer into an underlying impermeable soil or rock formation, some seepage will pass between the wellpoints at the lower boundary of the aquifer. This seepage may be intercepted with ditches or drains inside the excavation and removed by sump pumps. If the underlying stratum is a clay, the wellpoints may be installed in holes drilled about 1 to 2 feet into the clay and back-filled with filter material. By this procedure, the water level at the wellpoints can be maintained near the bottom of the aquifer, and thus seepage passing between the wellpoints will be minimized. Sometimes these procedures are ineffective, and a small dike in the ex-

cavation just inside the toe of the excavation may be required to prevent seepage from entering the work area. Sump pumping can be used to remove water from within the diked area.

(2) *Jet-eductor (well or) wellpoint systems.* Flow and drawdown to a jet-eductor (well or) wellpoint system can be computed or analyzed as discussed in paragraph 4-2b. Jet-eductor dewatering systems can be designed as follows:

Step 1. Assume the line or ring of wells or wellpoints to be a drainage slot.

Step 2. Compute the total flow to the system for the required drawdown and penetration of the well screens.

Step 3. Assume a well or wellpoint spacing that will result in a reasonable flow for the well or wellpoint and jet-eductor pump.

Step 4. Compute the head at the well or wellpoint h_w required to achieve the desired drawdown.

Step 5. Set eductor pump at $M = h_w - H_w$ with some allowance for future loss of well efficiency. The wells or wellpoints and filters should be selected and designed in accordance with the criteria set forth under paragraph 4-6.

(a) If the soil formation being drained is stratified and an appreciable flow of water must be drained down through the filter around the riser pipe to the wellpoint, the spacing of the wellpoints and the permeability of the filter must be such that the flow from formations above the wellpoints does not exceed

$$Q_w = k_v A i \quad (4-9)$$

where

Q_w = flow from formation above wellpoint

k_v = vertical permeability of filter

A = horizontal area of filter

i = gradient produced by gravity = 1.0

Substitution of small diameter well screens for wellpoints may be indicated for stratified formations. Where a formation is stratified or there is little available submergence for the wellpoints, jet-eductor wellpoints and risers should be provided with a pervious filter, and the wellpoints set at least 10 feet back from the edge of a vertical excavation.

(b) Jet-eductor pumps may be powered with individual small high-pressure centrifugal pumps or with one or two large pumps pumping into a single pressure pipe furnishing water to each eductor with a single return header. With a single-pump setup, the water is usually circulated through a stilling tank with an overflow for the flow from wells or wellpoints (fig. 2-6). Design of jet eductors must consider the static lift from the wells or wellpoints to the water level in the recirculation tank; head loss in the return riser pipe; head loss in the return header; and flow from the wellpoint. The (net) capacity of a jet-eductor pump depends on the pressure head, input flow, and diameter

of the jet nozzle in the pump. Generally, a jet-eductor pump requires an input flow of about 2 to 2% times the flow to be pumped depending on the operating pressure and design of the nozzle. Consequently, if flow from the wells or wellpoints is large, a deep-well system will be more appropriate. The pressure header supplying a system of jet eductors must be of such size that a fairly uniform pressure is applied to all of the eductors.

(3) *Vacuum wellpoint system.* Vacuum wellpoint systems for dewatering fine-g-rained soils are similar to conventional wellpoint systems except the wellpoint and riser are surrounded with filter sand that is sealed at the top, and additional vacuum pump capacity is provided to ensure development of the maximum vacuum in the wellpoint and filter regardless of air loss. In order to obtain 8 feet of vacuum in a wellpoint and filter column, with a pump capable of maintaining a 25-foot vacuum in the header, the maximum lift is 25-8 or 17 feet. Where a vacuum type of wellpoint system is required, the pump capacity is small. The capacity of the vacuum pump will depend on the air permeability of the soil, the vacuum to be maintained in the filter, the proximity of the wellpoints to the excavation, the effectiveness of the seal at the top of the filter, and the number of wellpoints being pumped. In very fine-g-rained soils, pumping must be continuous. The flow may be so small that water must be added to the system to cool the pump properly.

c. *Electroosmosis*

(1) An electroosmotic dewatering system consists of anodes (positive electrodes, usually a pipe or rod) and cathodes (negative electrodes, usually wellpoints or small wells installed with a surrounding filter), across which a d-c voltage is applied. The depth of the electrodes should be at least 5 feet below the bottom of the slope to be stabilized. The spacing and arrangement of the electrodes may vary, depending on the dimensions of the slope to be stabilized and the voltage available at the site. Cathode spacings of 25 to 40 feet have been used, with the anodes installed midway between the cathodes. Electrical gradients of 1.5- to 4-volts-per-foot distance between electrodes have been successful in electroosmotic stabilization. The electrical gradient should be less than about 15 volts per foot of distance between electrodes for long-term installations to prevent loss in efficiency due to heating the ground. Applied voltages of 30 to 100 volts are usually satisfactory; a low voltage is usually sufficient if the groundwater has a high mineral content.

(2) The discharge of a cathode wellpoint may be estimated from the equation

$$Q_e = k_e i_e a z \quad (4-10)$$

where

k_e = coefficient of electroosmotic permeability

(assume 0.98×10^{-4} feet per second per volt per foot)

i_e = electrical gradient between electrodes, volts per foot

a = effective spacing of wellpoints, feet

z = depth of soil being stabilized, feet

Current requirements commonly range between 15 and 30 amperes per well, and power requirements are generally high. However, regardless of the expense of installation and operation of an electroosmotic dewatering system, it may be the only effective means of dewatering and stabilizing certain silts, clayey silts, and clayey silty sands. Electroosmosis may not be applicable to saline soils because of high current requirements, nor to organic soils because of environmentally objectionable effluents, which may be unsightly and have exceptionally high pH values.

d. Deep-well systems

(1) The design and analysis of a deep-well system to dewater an excavation depends upon the configuration of the site dewatered, source of seepage, type of flow (artesian and gravity), penetration of the wells, and the submergence available for the well screens with the required drawdown at the wells. Flow and drawdown to wells can be computed or analyzed as discussed in paragraph 4-2b.

(2) Methods are presented in paragraphs 4-2b and 4-3 whereby the flow and drawdown to a well system can be computed either by analysis or by a flow net assuming a continuous slot to represent the array of wells, and the drawdown at and between wells computed for the actual well spacing and location. Examples of the design of a deep-well system using these methods and formulas are presented in figures D-2 and D-3.

(3) The submerged length and size of a well screen should be checked to ensure that the design flow per well can be achieved without excessive screen entrance losses or velocities. The pump intake should be set so that adequate submergence (a minimum of 2 to 5 feet) is provided when all wells are being pumped. Where the type of seepage (artesian and gravity) is not well established during the design phase, the pump intake should be set 5 to 10 feet below the design elevation to ensure adequate submergence. Setting the pump bowl below the expected drawdown level will also facilitate drawdown measurements.

e. Combined systems.

(1) *Well and wellpoint systems.* A dewatering system composed of both deep wells and wellpoints may be appropriate where the groundwater table has to be lowered appreciably and near to the top of an impermeable stratum. A wellpoint system alone would require several stages of wellpoints to do the job, and a well system alone would not be capable of lowering the

groundwater completely to the bottom of the aquifer. A combination of deep wells and a single stage wellpoints may permit lowering to the desired level. The advantages of a combined system, in which wells are essentially used in place of the upper stages of wellpoints, are as follows:

(a) The excavation quantity is reduced by the elimination of berms for installation and operation of the upper stages of wellpoints.

(b) The excavation can be started without a delay to install the upper stages of wellpoints.

(c) The deep wells installed at the top of the excavation will serve not only to lower the groundwater to permit installation of the wellpoint system but also to intercept a significant amount of seepage and thus reduce the flow to the single stage of wellpoints. A design example of a combined deep-well and wellpoint system is shown in figure D-4.

(2) *Sand drains with deep wells and wellpoints.* Sand drains can be used to intercept horizontal seepage from stratified deposits and conduct the water vertically downward into a pervious stratum that can be dewatered by means of wells or wellpoints. The limiting feature of dewatering by sand drains is usually the vertical permeability of the sand drains itself, which restricts this method of drainage to soils of low permeability that yield only a small flow of water. Sand drains must be designed so that they will intercept the seepage flow and have adequate capacity to allow the seepage to drain downward without any back pressure. To accomplish this, the drains must be spaced, have a diameter, and be filled with filter sand so that

$$Q_D \leq k_D i A_D = k_v A_D \tag{4-11}$$

where

Q_D = flow per drain

k_D = vertical permeability of sand filter

i = gradient produced by gravity = 1.0

A_D = area of drain

Generally, sand drains are spaced or 5- to 15-foot centers and have a diameter of 10 to 18 inches. The maximum permeability k_v of a filter that may be used to drain soils for which sand drains are applicable is about 1000 to 3000×10^{-4} centimetres per second or 0.20 to 0.60 feet per minute. Thus, the maximum capacity Q_D of a sand drain is about 1 to 3 gallons per minute. An example of a dewatering design, including sand drains, is presented in figure D-5. The capacity of sand drains can be significantly increased by installing a small (1- or 1½-inch) slotted PVC pipe in the drain to conduct seepage into the drain downward into underlying more pervious strata being dewatered.

f. Pressure relief systems.

(1) Temporary relief of artesian pressure beneath an open excavation is required during construction

where the stability of the bottom of the excavation is endangered by artesian pressures in an underlying aquifer. Complete relief of the artesian pressures to a level below the bottom of the excavation is not always required depending on the thickness, **uniformity**, and permeability of the materials. For uniform tight shales or clays, an upward seepage gradient i as high as 0.5 to 0.6 may be safe, but clay silts or silts generally require lowering the groundwater 5 to 10 feet below the bottom of the excavation to provide a dry, stable work area.

(2) The flow to a pressure relief system is artesian; therefore, such a system may be designed or evaluated on the basis of the methods presented in paragraphs 4-2 and 4-3 for *artesian flow*. The penetration of the wells or wellpoints need be no more than that required to achieve the required **drawdown** to keep the flow to the system a minimum. If the aquifer is stratified and anisotropic, the penetration required should be determined by computing the effective penetration into the transformed aquifer as described in appendix E. Examples of the design of a wellpoint system and a **deep-well** system for relieving pressure beneath an open excavation are presented in figures D-6 and D-7.

g. Cutoffs. Seepage cutoffs are used as barriers to flow in highly permeable aquifers in which the quantity of seepage would be too great to handle with **deep-well** or wellpoint dewatering systems alone, *or when pumping costs would be large and a cutoff is more economical.* The cutoff should be located far enough back of the excavation slope to ensure that the hydrostatic pressure behind the cutoff does not endanger the stability of the slope. If possible, a cutoff should penetrate several feet into an underlying impermeable stratum. However, the depth of the aquifer or other conditions may preclude full penetration of the cutoff, in which case seepage beneath the cutoff must be considered. Figure 4-36 illustrates the effectiveness of a partial cutoff for various penetrations into an aquifer. The figure also shows the soils to be homogeneous and isotropic with respect to permeability. If, however, the soils are stratified or anisotropic with respect to permeability, they must be transformed into an isotropic section and the equivalent penetration computed by the method given in appendix E before the curves shown in the figure are applicable.

(1) *Cement and chemical grout curtain.* Pressure injection of grout into a soil or rock may be used to reduce the permeability of the formation in a zone and seal off the flow of water. The purpose of the injection of grout is to fill the void spaces with cement or chemicals and thus form a solid mass through which no water can flow. Portland cement, fly ash, bentonite, and sodium silicate are commonly used as grout materials. Generally, grouting pressures should not exceed about

1 pound per square inch per foot of depth of the injection.

(a) Portland cement is best adapted to filling voids and fractures in rock and has the advantage of appreciably strengthening the formation, but it is ineffective in penetrating the voids of sand with an effective grain size of 1 millimetre or less. To overcome this deficiency, chemical grouts have been developed that have nearly the viscosity of water, when mixed and injected, and later react to form a gel which seals the **formation**. Chemical grouts can be injected effectively into soils with an effective grain size D_{10} that is less than 0.1 millimetre. Cement grout normally requires a day or two to hydrate and set, whereas chemical grout can be mixed to gel in a few minutes.

(b) Cement grouts are commonly mixed at water-cement ratios of from 5:1 to 10:1 depending on the grain size of the soils. However, the use of a high water-cement ratio will result in greater shrinkage of the cement, so it is desirable to use as little water as practical. Bentonite and screened fly ash may be added to a cement grout to both improve the workability and reduce the shrinkage of the cement. The setting time of a cement grout can be accelerated by using a 1:1 mixture of gypsum-base plaster and cement or by adding not more than 3 percent calcium chloride. **High-early-strength** cement can be used when a short set time is required.

(c) Chemical grouts, both liquid and powder-based, are diluted with water for injection, with the proportions of the chemicals and admixtures varied to control the gel time.

(d) Injection patterns and techniques vary with grout materials, character of the formation, and geometry of the grout curtains. (Grout holes are generally spaced on 2- to 5-foot centers.) Grout curtains may be formed by successively regrouting an area at reduced spacings until the curtain becomes tight. Grouting is usually done from the top of the formation downward.

(e) The most perplexing problem connected with grouting is the uncertainty about continuity and effectiveness of the seal. Grout injected under pressure will move in the direction of least resistance. If, for example, a sand deposit contains a layer of gravel, the gravel may take all the grout injected while the sand remains untreated. Injection until the grout take diminishes is not an entirely satisfactory measure of the success of a grouting operation. The grout may block the injection hole or penetrate the formation only a short distance, resulting in a discontinuous and ineffective grout curtain. The success of a grouting operation is difficult to evaluate before the curtain is complete and in operation, and a considerable construction delay can result if the grout curtain is not effective. A single row of grout holes is relatively ineffective for cutoff purposes compared with an effectiveness of 2 or 3 times

that of overlapping grout holes. Detailed information on grouting methods and equipment is contained in TM 5-818-6.

(2) *Slurry walls.* The principal features of design of a slurry cutoff wall include: viscosity of slurry used for excavation; specific gravity or density of slurry; and height of slurry in trench above the groundwater table. The specific gravity of the slurry and its level

above the groundwater table must be high enough to ensure that the hydrostatic pressure exerted by the slurry will prevent caving of the sides of the trench and yet not limit operation of the excavating equipment. Neither shall the slurry be so viscous that the backfill will not move down through the slurry mix. Typical values of specific gravity of slurries used range from about 1.1 to 1.3 (70 to 80 pounds per cubic foot)

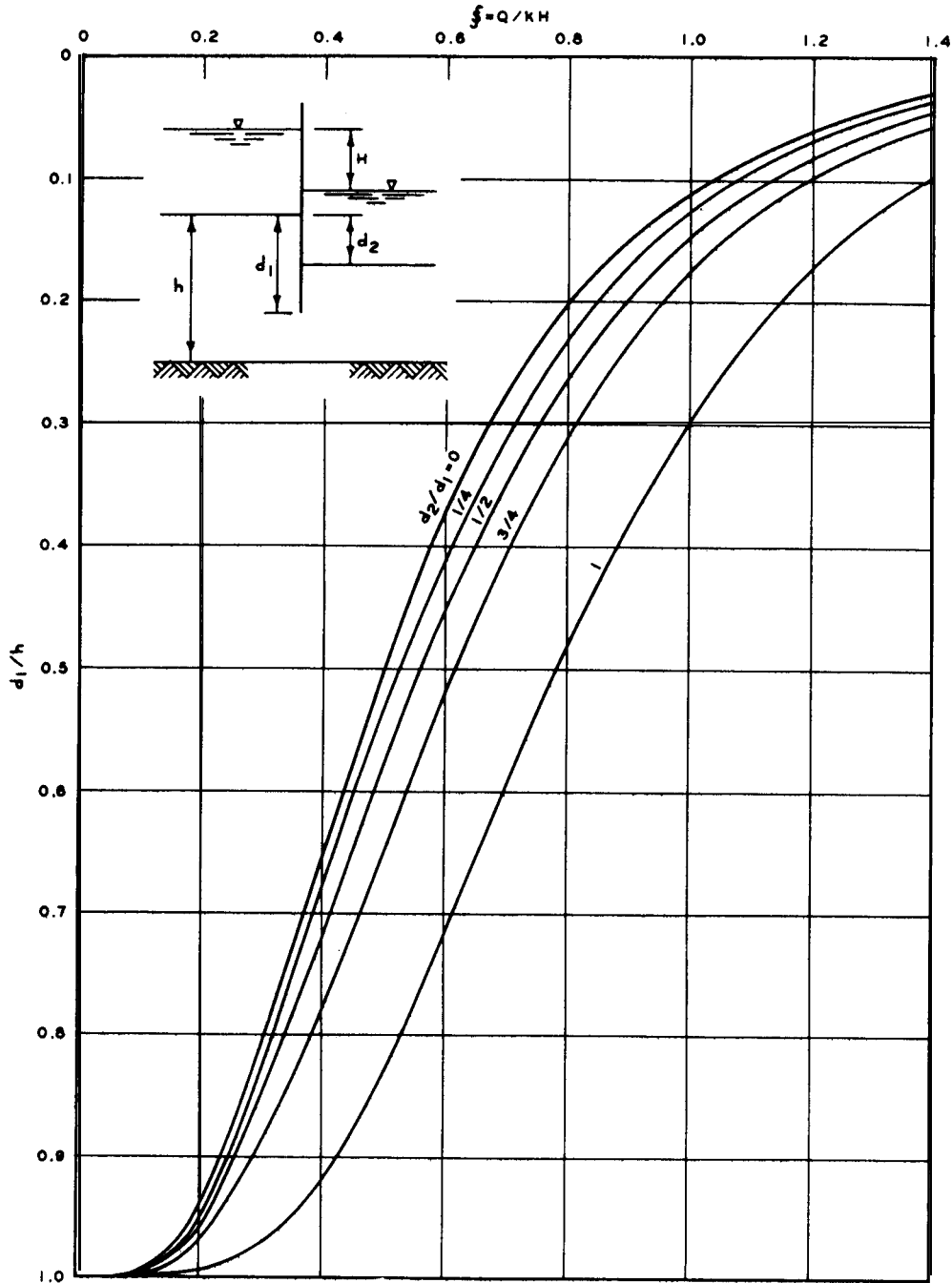

U. S. Army Corps of Engineers

Figure 4-36. Flow beneath a partially penetrating cutoff wall

with sand or weighting material added. The viscosity of the slurry for excavating slurry wall trenches usually ranges from a Marsh funnel reading of 65 to 90 seconds, as required to hold any weighting material added and to prevent any significant loss of slurry into the walls of the trench. The slurry should create a pressure in the trench approximately equal to 1.2 times the active earth pressure of the surrounding soil. Where the soil at the surface is loose or friable, the upper part of the trench is sometimes supported with sand bags or a concrete wall. The backfill usually consists of a mixture of soil (or a graded mix of sand-gravel-clay) and bentonite slurry with a slump of 4 to 6 inches.

(3) *Steel sheet piling.* Seepage cutoffs may be created by driving a sheet pile wall or cells to isolate an excavation in a river or below the water table. Sheet piles have the advantage of being commonly available and readily installed. However, if the soil contains cobbles or boulders, a situation in which a cutoff wall is applicable to dewatering, the driving may be very difficult and full penetration may not be attained. Also, obstructions may cause the interlocks of the piling to split, resulting in only a partial cutoff.

(a) Seepage through the sheet pile interlocks should be expected but is difficult to estimate. As an approximation, the seepage through a steel sheet pile wall should be assumed equal to at least 0.01 gallon per square foot of wall per foot of net head acting on the wall. The efficiency of a sheet pile cutoff is substantial for short paths of seepage but is small or negligible for long paths.

(b) Sheet pile cutoffs that are installed for long-term operation will usually tighten up with time as the interlocks become clogged with rust and possible incrustation by the groundwater.

(4) *Freezing.* Freezing the water in saturated porous soils or rock to form an ice cutoff to the flow of groundwater may be applicable to control of groundwater for shafts or tunnels where the excavation is small but deep. (See para 4-12 for information on design and operation of freezing systems.)

4-10. Dewatering shafts and tunnels.

a. The requirements and design of systems for dewatering shafts and tunnels in cohesionless, porous soil or rock are similar to those previously described for open excavations. As an excavation for a shaft or tunnel is generally deep, and access is limited, deep-wells or jet-eductor wellpoints are considered the best method for dewatering excavations for such structures where dewatering techniques can be used. Grout curtains, slurry cutoff walls, and freezing may also be used to control groundwater adjacent to shafts or tunnels.

b. Where the soil or rock formation is reasonably homogeneous and isotropic, a well or jet-eductor sys-

tem can be designed to lower the water table below the tunnel or bottom of the shaft using methods and formulas presented in paragraphs 4-1 through 4-4. If the soil or rock formation is stratified, the wells must be screened and filtered through each pervious stratum, as well as spaced sufficiently close so that the residual head in *each stratum* being drained is not more than 1 or 2 feet. Dewatering stratified soils penetrated by a shaft or tunnel by means of deep wells may be facilitated by sealing the wells and upper part of the riser pipe and applying a vacuum to the top of the well and correspondingly to the filter. Maintenance of a vacuum in the wells and surrounding earth tends to stabilize the earth and prevent the emergence of seepage into the tunnel or shaft.

c. In combined well-vacuum systems, it is necessary to use pumps with a capacity in excess of the maximum design flow so that the vacuum will be effective for the full length of the well screen. Submersible pumps installed in sealed wells must be designed for the static lift plus friction losses in the discharge pipe plus the vacuum to be maintained in the well. The pumps must also be designed so that they will pump water and a certain amount of air without cavitation. The required capacity of the vacuum pump can be estimated from formulas for the flow of air through porous media considering the maximum exposure of the tunnel facing or shaft wall at any one time to be the most pervious formation encountered, *assuming the porous stratum to be fully drained.* The flow of air through a porous medium, assuming an ideal gas flowing under isothermal conditions, is given in the following formula:

$$Q_a = \Delta p(D - h_w)k \frac{\mu_w}{\mu_a} \mathcal{S} \quad (4-12)$$

where

Q_a = flow of air at mean pressure of air in flow system \bar{p} , cubic feet per minute

A_w = pressure differential ($p_1 - p_2$) in feet of water

p_1 = absolute atmospheric pressure

p_2 = absolute air pressure at line of vacuum wells

D = thickness of aquifer, feet

h_w = head at well, feet

k = coefficient of permeability for water, feet per minute

μ_w = absolute viscosity of water

μ_a = absolute viscosity of air

\mathcal{S} = geometric seepage shape factor (para 4-3)

The approximate required capacity of vacuum pump is expressed as

$$Q_{a-vp} = Q_a \times \frac{\bar{p}}{\text{absolute atmospheric pressure (feet of water)}} \quad (4-13)$$

$$= \frac{Q_a \bar{p}}{34} \quad (\text{cubic feet per minute})$$

where \bar{p} represents mean absolute air pressure

$\left(\frac{P_1 + P_2}{2} \right)$ in feet of water. Wells, with vacuum, on

15- to 20-foot centers have been used to dewater caissons and mine shafts 75 to 250 feet deep. An example of the design of a deep-well system supplemented with vacuum in the well filter and screen to dewater a stratified excavation for a shaft is shown in figure D-8, and an example to dewater a tunnel is shown in figure D-9.

d. In designing a well system to dewater a tunnel or shaft, it should be assumed that any one well or pumping unit may go out of operation. Thus, any combination of the other wells and pumping units must have sufficient capacity to provide the required water table lowering or pressure relief. Where electrical power is used to power the pumps being used to dewater a shaft or tunnel, a standby generator should be connected to the system with automatic starting and transfer equipment or switches.

4-11. Permanent pressure relief systems. Permanent drainage or pressure relief systems can be designed using equations and considerations previously described for various groundwater and flow conditions. The well screen, collector pipes, and filters should be designed for long service and with access provided for inspection and reconditioning during the life of the project. Design of permanent relief or drainage systems should also take into consideration potential encrustation and screen loss. The system should preferably be designed to function as a gravity system without mechanical or electrical pumping and control equipment. Any mechanical equipment for the system should be selected for its simplicity and dependability of operation. If pumping equipment and controls are required, auxiliary pump and power units should be provided. Piezometers and flow measuring devices should be included in the design to provide a means for controlling the operation and evaluating its efficiency,

4-12. Freezing.

a. General.

(1) The construction of a temporary waterstop by artificially freezing the soil surrounding an excavation site is a process that has been used for over a century, not always with success and usually as a last resort when more conventional methods had failed. The method may be costly and is time-consuming. Until recent years far too little engineering design has been used, but nowadays a specialist in frozen-soil engineering, given the site information he needs, can design a freezing system with confidence. However, every job needs care in installation and operation and cannot be left to a general contractor without expert help. A fav-

orable site for artificial freezing is where the water table is high, the soil is, e.g., a running sand, and the water table cannot be drawn down because of possible damage to existing structures of water (in a coarser granular material). The freezing technique may be the best way to control water in some excavations, e.g., deep shafts.

(2) Frozen soil not only is an effective water barrier but also can serve as an excellent cofferdam. An example is the frozen cofferdam for an open excavation 220 feet in diameter and 100 feet deep in rubbishy fill, sands, silts, and decomposed rock. A frozen curtain wall 4000 feet long and 65 feet deep has been successfully made but only after some difficult problems had been solved. Mine shafts 18 feet in diameter and 2000 feet deep have been excavated in artificially frozen soils and rocks where no other method could be used. Any soil or fractured rock can be frozen below the water table to form a watertight curtain provided the freeze-pipes can be installed, but accurate site data are essential for satisfactory design and operation.

b. Design. As with the design of any system for subsurface water control, a thorough site study must first be made. *Moving water is the factor most likely to cause failure;* a simple sounding-well or piezometer layout (or other means) must be used to check this. If the water moves across the excavation at more than about 4 feet per day, the designer must include extra provisions to reduce the velocity, or a curtain wall may never close. If windows show up in the frozen curtain wall, flooding the excavation and refreezing with added freeze-pipes are nearly always necessary. A knowledge of the creep properties of the frozen soils may be needed; if the frozen soil is used as a cofferdam or earth retaining structure, such can be determined from laboratory tests. Thermal properties of the soils can usually be reliably estimated from published data, using dry unit weight and water content.

c. Operation. The ground is frozen by closed-end, steel freeze-pipes (usually vertical, but they can be driven, placed, or jacked at any angle) from 4 to 6 inches in diameter, spaced from 3 to 5 feet in one or more rows to an impervious stratum. If there is no impervious stratum within reach, the soil may be completely frozen as a block in which the excavation is made, or an impervious stratum may be made artificially. In one project, a horizontal disk about 200 feet across and 24 feet thick was frozen at a minimum depth of 150 feet. Then, a cylindrical cofferdam 140 feet in diameter was frozen down to the disk, and the enclosed soil was excavated without any water problem.

(1) Coaxial with each freeze-pipe is a 1% to 2-inch steel, or plastic, supply pipe delivering a chilled liquid (coolant) to the bottom of the closed freeze pipe. The

coolant flows slowly up the **annulus** between the pipes, pulls heat from the ground, and progressively freezes the soil, (A typical freeze-pipe is shown in fig. 4-37.) After a week or two, the separate cylinders of frozen soil join to form the barrier, which gradually thickens to the designed amount, generally at least 4 feet (walls of **24-foot** thickness with two rows of freeze-pipes have been frozen in large and deep excavations in soft organic silts), The total freeze-time varies from 3 to 4 weeks to 6 months or more but is predictable with high accuracy, and by instrumentation and observation the engineer has good control. Sands of low water content freeze fastest; **fine-grained** soils of high water content take more time and total energy, although the refrigeration horsepower required may be greater than for sands.

(2) The coolant is commonly a chloride brine at zero to -20 degrees Fahrenheit, but lower temperatures are preferable for saving time, reducing the amount of heat to be extracted, and minimizing **frost-heave** effects (which must be studied beforehand). In recent years, liquid propane at -45°F has been used in large projects, and for small volumes of soil, liquid nitrogen that was allowed to waste has been used. (These cryogenic liquids demand special care-they are dangerous.) Coolant circulation is by headers, commonly **8-inch** pipes, connected to a heat-exchanger at the refrigeration plant using freon (in a modern plant) as the refrigerant. The refrigeration equipment is usually rented for the job. A typical plant requires from 50 horsepower and up; 1000 horsepower or more has sometimes been used, Headers should be insulated and are recoverable. Freeze-pipes may be withdrawn but

are often wasted in construction; they are sometimes used for thawing the soil back to normal, in which case they could be pulled afterward.

d. Important considerations. The following items must be considered when the freezing technique is to be used:

- (1) Water movement in soil.
- (2) Location of freeze-pipes. (The spacing of freeze-pipes should not exceed the designed amount by more than 1 foot anywhere along the freeze wall.)
- (3) Wall closure. (Freeze-pipes must be accurately located, and the temperature of the soil to be frozen carefully monitored with thermocouples to ensure 100 percent closure of the wall. Relief wells located at the center of a shaft may also be used to check the progress of freezing. By periodically pumping these wells, the effectiveness of the ice wall in sealing off seepage flow can be determined.)
- (4) Frost-heave effects-deformations and pressures. (Relief wells may be used to relieve pressures caused by expansion of frozen soil.)
- (5) Temperature effects on buried utilities.
- (6) Insulation of aboveground piping.
- (7) Control of surface water to prevent flow to the freezing region.
- (8) Coolant and ground temperatures. (By monitoring coolant and soil temperatures, the efficiency of the freezing process can be improved.)
- (9) Scheduling of operations to minimize lost time when freezing has been completed.
- (10) Standby plant. (Interruption of coolant circulation may be serious. A standby plant with its own prime movers is desirable so as to prevent any thaw. A continuous advance of the freezing front is not necessary so that standby plant capacity is much less than that normally used.)

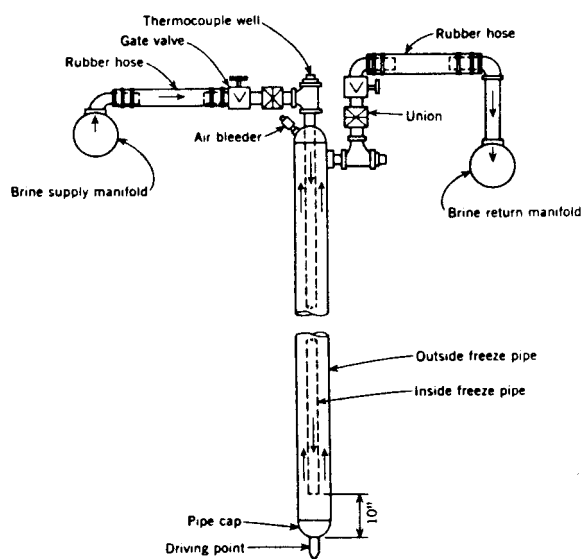

(From "Tunnel Driven Using Subsurface Freezing," by C. P. Gail, pp. 37-40. Civil Engineering, American Society of Civil Engineers, May 1972.)

Figure 4-37. Typical freeze-pipe.

4-13. Control of surface water.

a. Runoff of surface water **from** areas surrounding the excavation should be prevented from entering the excavation by sloping the ground away from the excavation or by the construction of dikes around the top of the excavation. Ditches and dikes can be constructed on the slopes of an excavation to control the runoff of water and reduce surface erosion. Runoff into slope ditches can be removed by pumping from **sumps** installed in these ditches, or it can be carried in a pipe or lined ditch to a central sump in the bottom of the excavation where it can be pumped out, Dikes at the top of an excavation and on slopes should have at least **1 foot** of freeboard above the maximum elevation of water to be impounded and a crown width of 3 to 5 feet with side slopes of 1V on 2-2.5H.

b. In designing a dewatering system, provision must be made for collecting and pumping out surface water

SO that the dewatering wells and pumps cannot be flooded. Control of surface water within the diked area will not only prevent interruption of the dewatering operation, which might seriously impair the stability of the excavation, but also prevent damage to the construction operations and minimize interruption of work. Surface water may be controlled by dikes, ditches, sumps, and pumps; the excavation slope can be protected by seeding or covering with fabric or asphalt. Items to be considered in the selection and design of a surface water control system include the duration and season of construction, rainfall frequency and intensity, size of the area, and character of surface soils.

c. The magnitude of the rainstorm that should be used for design depends on the geographical location, risk associated with damage to construction or the dewatering system, and probability of occurrence during construction. The common frequency of occurrence used to design surface water control sumps and pumps is a once in 2-to 5-year rainfall. For critical projects, a frequency of occurrence of once in 10 years may be advisable.

d. Impounding runoff on excavation slopes is somewhat risky because any overtopping of the dike could result in overtopping of all dikes at lower elevations with resultant flooding of the excavation.

e. Ample allowance for silting of ditches should be made to ensure that adequate capacities are available throughout the duration of construction. The grades of ditches should be fairly flat to prevent erosion. Sumps should be designed that will minimize siltation and that can be readily cleaned. Water from sumps should not be pumped into the main dewatering system.

f. The pump and storage requirements for control of surface water within an excavation can be estimated in the following manner:

Step 1. Select frequency of rainstorm for which pumps, ditches, and sumps are to be designed.

Step 2. For selected frequency (e.g., once in 5 years), determine rainfall for 10-, 30-, and 60-minute rainstorms at project site from figure 3-6.

Step 3. Assuming instantaneous runoff, compute volume of runoff V_R (for each assumed rainstorm)

into the excavation or from the drainage area into the excavation from the equation

$$V_R = cRA = c \frac{R}{12} 43,560A \text{ (cubic feet)} \quad (4-14)$$

where

c = coefficient of runoff

R = rainfall for assumed rainstorm, inches

A = area of excavation plus area of drainage into excavation, acres

(The value of c depends on relative porosity, character, and slope of the surface of the drainage area. For impervious or saturated steep excavations, c values may be assumed to range from 0.8 to 1.0.)

Step 4. Plot values of V_R versus assumed duration of rainstorm.

Step 5. Plot pumpage rate of pump to be installed assuming pump is started at onset of rain. This method is illustrated by figure D-10.

g. The required ditch and sump storage volume \bar{V} is the (maximum) difference between the accumulated runoff for the various assumed rainstorms and the amount of water that the sump pump (or pumps) will remove during the same elapsed period of rainfall. The capacity and layout of the ditches and sumps can be adjusted to produce the optimum design with respect to the number, capacity, and location of the sumps and pumps.

h. Conversely, the required capacity of the pumps for pumping surface runoff depends upon the volume of storage available in sumps, as well as the rate of runoff (see equation (3-3)). For example, if no storage is available, it would be necessary to pump the runoff at the rate it enters the excavation to prevent flooding. This method usually is not practicable. In large excavations, sumps should be provided where practicable to reduce the required pumping capacity. The volume of sumps and their effect on pump size can be determined graphically (fig. D-10) or can be estimated approximately from the following equation:

$$Q_P = Q - \bar{V}/T \quad (4-15)$$

where

Q_P = total pump capacity, cubic feet per second

Q = average rate of runoff, cubic feet per second

\bar{V} = volume of sump storage, cubic feet

T = duration of rainfall, hours

CHAPTER 5

INSTALLATION OF **DEWATERING** AND GROUNDWATER CONTROL SYSTEMS

5-1. General. The successful performance of any dewatering system requires that it be properly installed. Principal installation features of various types of dewatering or groundwater control systems are presented in the following paragraphs.

5-2. Deep-well systems.

a. Deep wells may be installed by the *reverse-rotary* drilling method, by driving and jetting a casing into the ground and cleaning it with a bailer or jet, *or* with a bucket auger.

b. In the reverse-rotary method, the hole for the well is made by rotary drilling, using a bit of a size required by the screen diameter and thickness of filter. Soil from the drilling is removed from the hole by the flow of water circulating from the ground surface down the hole and back up the (hollow) drill stem from the bit. The drill water is circulated by a centrifugal or jet-eductor pump that pumps the flow from the drill stem into a sump pit. As the hole is advanced, the soil particles settle out in the sump pit, and the muddy water flows back into the drill hole through a ditch cut from the sump to the hole. The sides of the drill hole are stabilized by seepage forces acting against a thin film of finegrained soil that forms on the wall of the hole. A sufficient seepage force to stabilize the hole is produced by maintaining the water level in the hole at least 7 feet above the natural water table. No *bentonite drilling mud* should be used because of gelling in the filter and aquifer adjacent to the well. If the hole is drilled in clean sands, some silt soil may need to be added to the drilling water to attain the desired degree of muddiness (approximately 3000 parts per million). (Organic drilling material, e.g., Johnson's Revert or equivalent, may also be added to the drilling water to reduce water loss.) The sump pit should be large enough to allow the sand to settle out but small enough so that the silt is kept in suspension.

c. Holes for deep wells should be vertical so that the screen and riser may be installed straight and plumb; appropriate guides should be used to center and keep the screen plumb and straight in the hole. The hole should be some deeper than the well screen and riser. (The additional depth of the hole is to provide space for wasting filter material first put in the tremie pipe if used.) After the screen is in **place**, the filter is **tre-**

mied in. The tremie pipe should be 4 to 5 inches in diameter, be perforated with slots $\frac{1}{16}$ to $\frac{3}{32}$ inch wide and about 6 inches long, and have flush screw joints. The slots will allow the filter material to become saturated, thereby breaking the surface tension and "bulking" of the filter in the tremie. One or two slots per linear foot of tremie is generally sufficient. After the tremie pipe has been lowered to the bottom of the hole, it should be filled with filter material, and then slowly raised, keeping it full of filter material at all times, until the filter material is 5 to 10 feet above the top of the screen. The filter material initially poured in the tremie should be wasted in the bottom of the hole. The level of drilling fluid or water in a reverse-rotary drilled hole must be maintained at least 7 feet above the natural groundwater level until all the filter material is placed. If a casing is used, it should be pulled as the filter material is placed, keeping the bottom of the casing 2 to 10 feet below the top of the filter material as the filter is placed. A properly designed, uniform ($D_{90}/D_{10} \leq 3$ to 4) filter sand may be placed without tremieing if it is poured in around the screen in a heavy continuous stream to minimize segregation.

d. After the filter is placed, the well should be developed to obtain the maximum yield and efficiency of the well. The purpose of the development is to remove any film of silt from the walls of the drilled hole and to develop the filter immediately adjacent to the screen to permit an easy flow of water into the well. Development of a well should be accomplished as soon after the hole has been drilled as practicable. Delay in doing this may prevent a well being developed to the efficiency assumed in design. A well may be developed by surge pumping or surging it with a loosely fitting surge block that is raised and lowered through the well screen at a speed of about 2 feet per second. The surge block should be slightly flexible and have a diameter 1 to 2 inches smaller than the inside diameter of the well screen. The amount of material deposited in the bottom of the well should be determined after each cycle (about 15 trips per cycle). Surging should continue until the accumulation of material pulled through the well screen in any one cycle becomes less than about 0.2 foot deep. The well screen should be bailed clean if the accumulation of material in the bottom of the screen becomes more than 1 to 2 feet at any time **dur-**

ing surging, and recleaned after surging is completed. Material bailed from a well should be inspected to see if any foundation sand is being removed. It is possible to oversurge a well, which may breach the filter with resulting infiltration of foundation sand when the well is pumped.

e. After a well has been developed, it should be pumped to clear it of muddy water and sand and to check it for yield and infiltration. The well should be pumped at approximately the design discharge from 30 minutes to several hours, with periodic measurement of the well flow, drawdown in the well, depth of sand in the bottom of the well, and amount of sand in the discharge. Measurements of well discharge and drawdown may be used to determine the efficiency and degree of development of the well. The performance of the well filter may be evaluated by measuring the accumulation of sand in the bottom of the well and in the discharge. A well should be developed and pumped until the amount of sand infiltration is less than 5 to 10 parts per million.

f. Deep wells, in which a vacuum is to be maintained, require an airtight seal around the well riser pipe from the ground surface down for a distance of 10 to 50 feet. The seal may be made with compacted clay, nonshrinking grout or concrete, bentonitic mud, or a short length of surface casing capped at the top. Improper or careless placement of this seal will make it impossible to attain a sufficient vacuum in the system to cause the dewatering system to operate as designed. The top of the well must also be sealed airtight.

g. After the wells are developed and satisfactorily tested by pumping, the pumps, power units, and discharge piping may be installed.

h. Where drawdown or vacuum requirements in deep wells demand that the water level be lowered and maintained near the bottom of the wells the pumps will have to handle a mixture of water and air. If such a requirement exists, the pump bowls should be designed to allow increasing amounts of air to enter the bowl, which will reduce the efficiency of the pump until the pump capacity just equals the inflow of water, without cavitation of the impellers. The impellers of deep-well turbine pumps should be set according to the manufacturer's recommendations. Improper impeller settings can significantly reduce the performance of a deep-well pump.

5-3. Wellpoint systems.

a. Wellpoint systems are installed by first laying the header at the location and elevation called for by the plans as illustrated in figure 5-1. After the header pipe is laid, the stopcock portion of the swing connection should be connected to the header on the spacing called for by the design, and all fittings and plugs in the header made airtight using a pipe joint compound to prevent leakage. Installation of the wellpoints generally follows layout of the header pipe.

b. Self-jetting wellpoints are installed by jetting them into the ground by forcing water out the tip of the wellpoint under high pressure. The jetting action of a typical self-jetting wellpoint is illustrated in fig-

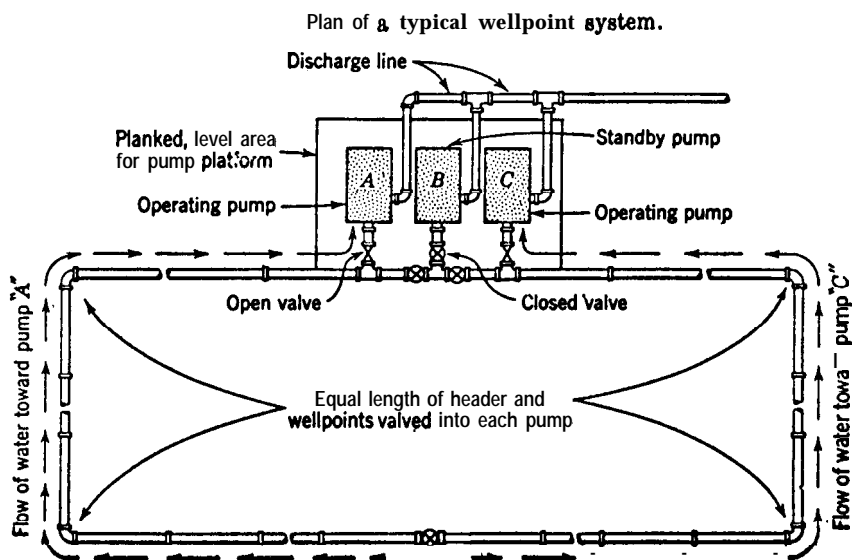

(From "Foundation Engineering," G. A. Leonards, ed., 1962, McGraw-Hill Book Company. Used with permission of McGraw-Hill Book Company.)

Figure 5-1. Plan of a typical wellpoint system.

ure 5-2. Self-jetting wellpoints can be installed in medium and fine sand with water pressures of about 50 pounds per square inch. Wellpoints jetted into coarse sand and gravel require considerably more water and higher water pressures (about 125 pounds per square inch) to carry out the heavier particles; either a hydrant or a jetting pump of appropriate size for the pressures and quantities of jetting water required can be used. The jetting hose, usually 2 to 3 inches in diameter, is attached to the wellpoint riser, which is picked up either by a crane or by hand and held in a vertical position as the jet water is turned on. The wellpoint is allowed to sink slowly into the ground and is slowly raised and lowered during sinking to ensure that all fine sand and dirt are washed out of the hole. Care should be taken to ensure that a return of jet water to the surface is maintained; otherwise, the point may “freeze” before it reaches grade. If the return of jet water disappears, the point should be quickly raised until circulation is restored and then slowly re-lowered. In gravelly soils, it may be necessary to supplement the jet water with a separate air supply at about 125 pounds per square inch to lift the gravel to the surface. If filter sand is required around the wellpoint to increase its efficiency or prevent infiltration of foundation soils, the wellpoints generally should be installed

using a hole puncher and a jet casing to form the hole for the wellpoint and filter. When the wellpoint reaches grade and before the water is turned off, the two halves of a swing connection, if used, should be lined up for easy connection when the jet water is turned off and the jetting hose disconnected.

c. Where a wellpoint is to be installed with a filter (i.e. “sanded”), generally the wellpoint should be installed in a hole formed by jetting down a 10- to 12-inch heavy steel casing. The casing may be fitted with a removable cap at the top through which air and water may be introduced. The casing is jetted into the ground with a return of air and water along the outside of the casing. Jetting pressures of 125 pounds per square inch are commonly used; where resistant strata are encountered, the casing may have to be raised and dropped with a crane to chop through and penetrate to the required depth. A casing may also be installed using a combination jetting and driving tool, equipped with both water and air lines, which fits inside the casing and extends to the bottom of the casing. Most of the return water from a “hole puncher” rises inside the casing, causing considerably less disturbance of the adjacent foundation soils. After the casing is installed to a depth of 1 to 3 feet greater than the length of the as-

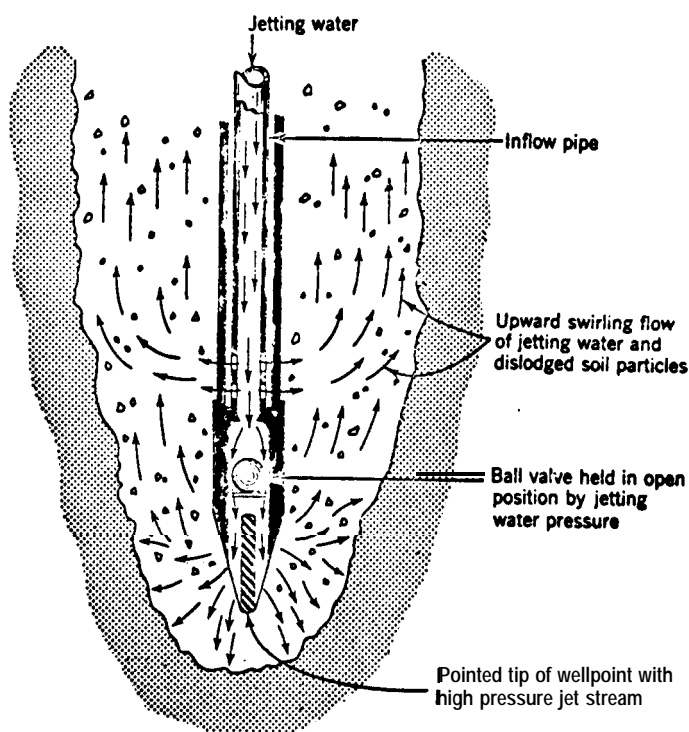

(Courtesy of Griffin Wellpoint Corp.)

Figure 5-2. Self-jetting wellpoint.

sembled wellpoint, the jet is allowed to run until the casing is flushed clean with clear water.

d. The wellpoint is placed in the casing, the sand filter tremied or poured in, and the casing pulled. Care should be taken to center the wellpoint in the casing so that it is completely surrounded with filter material. Before the wellpoint is connected to the header, it should be pumped to flush it and the filter and to check it for "sanding." All joints connecting wellpoints to the header should be made airtight to obtain the maximum needed vacuum.

e. Wellpoint pumps, similar to that shown in figure 5-3, are used to provide the vacuum and to remove water flowing to the system. To obtain the maximum

possible vacuum, the suction intake of the pump should be set level with the header pipe, Wellpoint pumps should be protected from the weather by a shelter and from surface water or sloughing slopes by ditches and dikes. The discharge pipe should be watertight and supported independently of the pump.

f. Vacuum wellpoint systems are installed in the same manner as ordinary wellpoint systems using a jet casing and filter, except the upper 5 feet of the riser is sealed airtight to maintain the vacuum in the filter.

g. Jet-eductor wellpoints are usually installed using a hole puncher and surrounding the wellpoint and riser pipe with filter sand. Jet eductors are connected to two headers-one for pressure to the eductors and

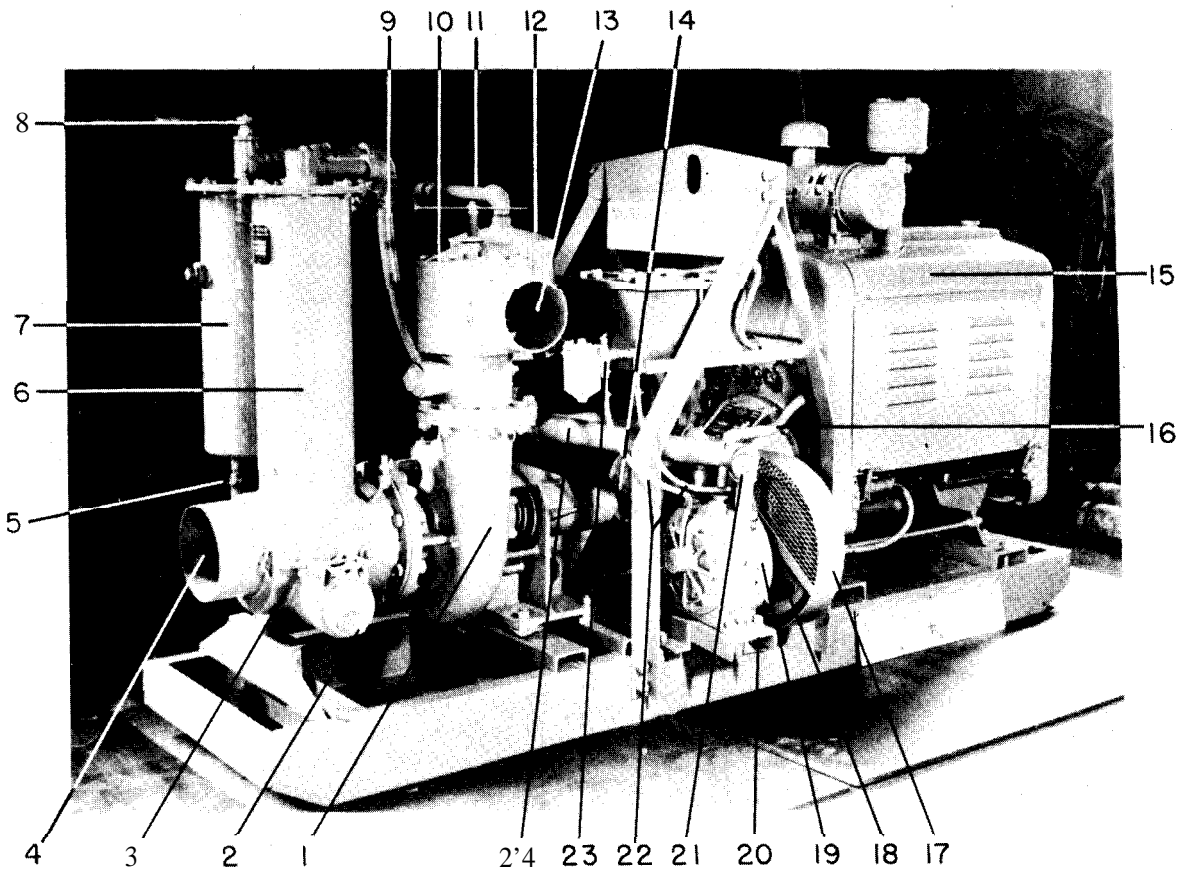

- | | | |
|---------------------------------|--|--|
| 1. Centrifugal Pump Volute | 9. Air Suction Line Wiper Float Chamber to Vacuum Pump | 16. Cooling Water Line for Vacuum Pump |
| 2. Cleanout | 10. Discharge Check Valve | 17. Belt Guard |
| 3. Screenbox | 11. Vacuum Pump Exhaust | 18. Vacuum Pump Pulley |
| 4. Suction or Header Connection | 12. Oil Reclaimer for Vacuum Pump | 19. MT71-4 Rotary-Type Vacuum Pump |
| 5. Wiper Float Drain Line | 13. Discharge Connection | 20. Vacuum Pump Rocker-Type Base |
| 6. Scrubber Float Chamber | 14. Flexible Coupling | 21. Vacuum Pump Exhaust Thermometer |
| 7. Wiper Float Chamber | 15. Engine | 22. Vacuum Pump Oil Supply Lines |
| 8. Air Vent Valve | | 23. Oil Dripper/Lubricator for Vacuum Pump |

(Courtesy of Moretrench American Corp.)

Figure 5-3. Characteristic parts of a wellpoint pump.

another for return flow from the **eductors** and the wellpoints back to the recirculation tank and pressure pump.

5-4. Vertical sand drains. Vertical sand drains can be installed by jetting a **12- to 18-inch** casing into the soil to be drained; thoroughly flushing the casing with clear water; filling it with clean, properly graded filter sand; and pulling the casing similar to installing “sanded” wellpoints. It is preferable to place the filter sand through a tremie to prevent segregation, which may result in portions of the filter being too coarse to filter **fine-grained** soils and too fine to permit vertical drainage. Sand drains should penetrate into the underlying pervious aquifer to be drained by means of wells or wellpoints.

5-5. cutoff **s.**

a. Cement and chemical grout curtains.

(1) Cement or chemical grouts are injected through pipes installed in the soil or rock. Generally, pervious soil or rock formations are grouted from the top of the formation downward. When this procedure is followed, the hole for the grout pipe is first cored or drilled down to the first depth to be grouted, the grout pipe and packer set, and the first zone grouted. After the grout is allowed to set, the hole is redrilled and advanced for the second stage of grouting, and the above procedure repeated. This process is repeated until the entire depth of the formation has been grouted. No drilling mud should be used in drilling holes for grout pipes because the sides of the hole will be plastered with the mud and little, if any, penetration of grout will be achieved.

(2) Mixing tanks and pump equipment for pressure injection of cement or chemical grouts vary depending upon the materials being handled. Ingredients for a grout mix are loaded into a mixing tank equipped with an agitator and, from there, are pumped to a storage tank also equipped with an agitator. Pumps for grouting with cement are generally duplex, positive displacement, reciprocating pumps similar to slush pumps used in oil fields. Cement grouts are highly abrasive, so the cylinder liners and valves should be of case-hardened steel. Chemical grouts, because of their low viscosity and nonabrasive nature, can be pumped with any type of pump that produces a satisfactory pressure. Grout **pump** capacities commonly range from 20 to 100 gallons per minute at pressures ranging from 0 to 500 pounds per square inch. The maximum grout pressure used should not exceed about 1 pound per square inch times the depth at which the grout is being injected.

(3) The distribution system for grouting may be either of two types: a single-line system or a recirculating system. Because of segregation that may de-

velop in the pressure supply line from the pump to the grout injection pipe, the line must occasionally be flushed to ensure that the grout being pumped into the formation is homogeneous and has the correct viscosity. The grout in a single-line system is flushed through a blowoff valve onto the ground surface and wasted. A recirculating system has a return line to the grout storage tank so that the grout is constantly being circulated through the supply line, with a tap off to the injection pipe where desired.

(4) Additional information on grouting is contained in TM 5-818-6.

b. Slurry walls.

(1) Slurry cutoff trenches can be dug with a trenching machine, backhoe, dragline, or a clam bucket, typically 2 to 5 feet wide. The walls of the trench are stabilized with a thick bentonitic slurry until the trench can be backfilled. The bentonitic slurry is best mixed at a central plant and delivered to the trench in trucks or pumped from slurry ponds. The **trench** is carried to full depth by excavation through the slurry, with the trench being maintained full of slurry by the addition of slurry as the trench is deepened and extended.

(2) With the trench open over a limited length and to full depth, cleaning of the slurry is commenced in order to remove gravelly or sandy soil particles that have collected in the slurry, especially near the bottom of the trench. Fair cleanup can be obtained using a clamshell bucket; more thorough cleaning can be obtained by airlifting the slurry to the surface for circulation through desanding units. Cleaning of the slurry makes it less viscous and ensures that the slurry will be displaced by the soilbentonite backfill. After cleaning the “in-trench” slurry, the trench is generally backfilled with a well-graded mix of sand-clay-gravel and bentonite slurry with a slump of about 4 to 6 inches. The backfill material and slurry may be mixed either along and adjacent to the trench or in a central mixing plant and delivered to the trench in trucks.

(3) The backfill is introduced at the beginning of the trench so as to displace the slurry toward the advancing end of the trench. In the initial stages of backfill, special precautions should be taken to ensure that the backfill reaches the bottom of the trench and that it assumes a proper slope (generally **1V on 5H to 1V on 10H**). In order to achieve this slope, the first backfill should be placed by clamshell or allowed to flow down an inclined ramp, dug at the beginning end of the trench. As the surface of the backfill is built up to the top of the trench, digging the trench resumes as shown in figure 5-4. As the backfill is bulldozed into the back of the trench, it flows down the sloped face of the already placed backfill, displacing slurry as it advances. Proper control of the properties of the slurry and back-

fill is required to ensure that the slurry is not trapped within the backfill.

(4) The backfill should be placed continuously as the trench is advanced. By so doing, sloughing of the trench walls will be minimized, and the amount of bentonitic slurry required kept to a minimum. The level of the slurry in the trench should be maintained at least 5 feet above the groundwater table. Care should be taken to control the density and viscosity of the bentonitic slurry as required by the design. To minimize wastage of bentonitic slurry, it may be necessary to screen out sand and gravel in order to reuse the slurry. (Construction techniques are still being developed.)

(5) The toe of the backfill slope should be kept within 50 to 150 feet of the leading edge of the trench to minimize the open length of the slurry-supported trench. During placement operations, excavation and cleaning operations proceed simultaneously ahead of the advancing backfill. (It should be noted that because of the geometric constraints set by the backfill slope, the amount of open trench length supported by slurry is a function of the depth of the trench. For example, if the trench is 100 feet deep and the backfill slope is 1V on 8H, the open length will be about 900 to 950 feet-800 feet along the slope of the backfill face plus 100 to 150 feet from the backfill toe to the leading edge of the trench.)

(6) When the trench is complete and the backfill occupies the entire trench, a compacted clay cap is normally placed over the trench. Key steps in this construction sequence involve the mixing of the bentonite-water slurry, excavation and stabilization of the trench, cleaning of the slurry, mixing of the soil-bentonite backfill, displacement of the slurry by the backfill, and treatment of the top of the trench. Each of these items must be covered in the specifications.

c. *Steel sheet piling.* Steel sheet pile cutoffs are constructed employing the same general techniques as those used for driving steel sheet piles. However, precautions should be taken in handling and driving sheet piling to ensure that the interlocks are tight for the full depth of the piling and that all of the sheets are driven into the underlying impermeable stratum at all locations along the sheet pile cutoff. Methods and techniques for driving steel sheet piling are described in numerous references on this subject.

d. *Freezing.* Freezing the soil around a shaft or tunnel requires the installation of pipes into the soil and circulating chilled brine through them. These pipes generally consist of a 2-inch inflow pipe placed in a 6-inch closed-end "freezing" pipe installed in the ground by any convenient drilling means. Two headers are required for a freezing installation: one to carry chilled brine from the refrigeration plant and the other to carry the return flow of refrigerant. The refrigeration plant should be of adequate capacity and should include standby or auxiliary equipment to maintain a continuous operation.

5-6. Piezometers.

a. *Installation.* Piezometers are installed to determine the elevation of the groundwater table (gravity or artesian) for designing and evaluating the performance of a dewatering system. For most dewatering applications, commercial wellpoints or small screens are satisfactory as piezometers. The selection of wellpoint or screen, slot size, need for filter, and method of installation is the same for piezometers as for dewatering wellpoints. Holes for the installation of piezometers can be advanced using continuous flight auger with a hollow stem plugged at the bottom with a removable

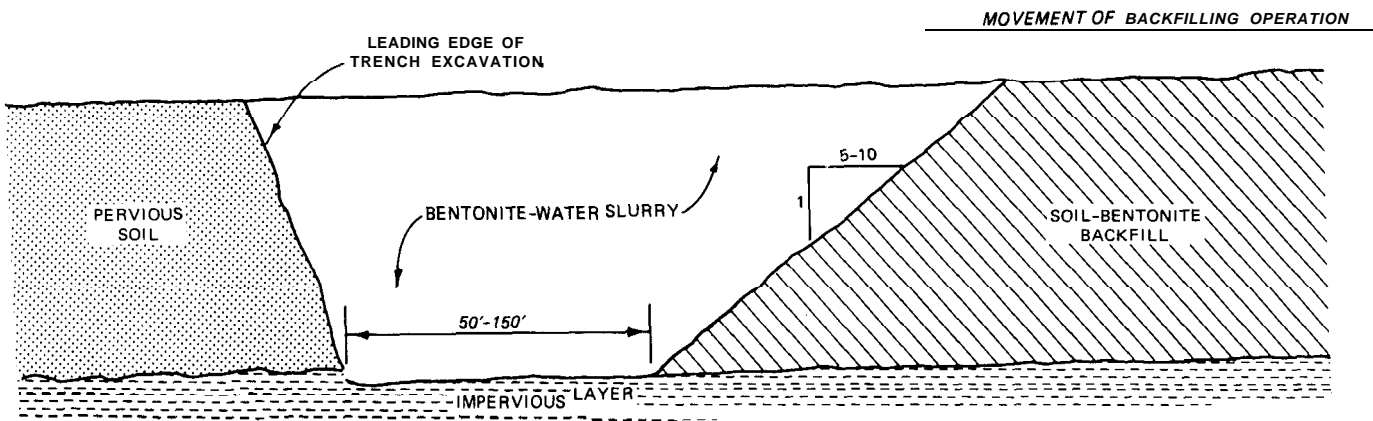

U. S. Army Corps of Engineers

Figure 5-4. Installation of a slurry cutoff trench.

plug, augering with more or less simultaneous installation of a casing, or using rotary wash-boring methods. The hole for a piezometer should be kept filled with water or approved drilling fluid at all times. **Bentonitic** drilling mud should not be used; however, an organic type of drilling fluid, such as Johnson's Revert or equivalent, may be used if necessary to keep the drilled hole open. Any auger used in advancing the hole should be withdrawn slowly from the hole so as to minimize any suction effect caused by its removal. When assembling piezometers, all fittings should be tight and sealed with joint compound so that water levels measured are those actually existing at the location of the wellpoint screen. Where the water table in different pervious formations is to be measured, the riser pipe from the piezometer tip must be sealed from the top of the screen to the ground surface to preserve the isolation of one stratum from another and to obtain the true water level in the stratum in which the piezometer is set. Such piezometers may be sealed by grouting the hole around the riser with a nonshrinking grout of bentonite, cement, and fly ash or other suitable admixture. Proportions of 1 sack of cement and 1 gallon of bentonite to 10 gallons of water have been found to be a suitable grout mix for this purpose. Fly ash can be used to replace part of the cement to reduce heat of hydration, but it does reduce the strength of the grout. The tops of piezometer riser pipes should be threaded and fitted with a vented cap to keep dirt and debris from entering the piezometer and to permit the water level in the piezometer to adjust to any changes in the natural water table.

(1) *Hollow-stem auger method.*

(a) After the hole for the piezometer is advanced to grade, 1 to 2 feet below the piezometer tip, or after the last sample is taken in a hole to receive a **piezometer**, the hollow-stem auger should be flushed clean with water and the plug reinserted at the bottom of the auger. The auger should then be slowly raised to the elevation that the piezometer tip is to be installed. At this elevation, the hollow stem should be filled with clean water and the plug removed. Water should be added to keep the stem full of water during withdrawal of the plug. The hole should then be sounded to determine whether or not the hollow stem is open to the bottom of the auger. If material has entered the hollow stem of the auger, the hollow stem should be cleaned by flushing with clear water, or fresh Johnson's Revert or **equivalent** drilling fluid if necessary to stabilize the bottom of the hole, through a bit designed to deflect the flow of water upward, until the discharge is free of soil particles. The piezometer screen and riser should then be lowered to the proper depth inside the hollow stem and the filter sand placed. A wire spider should be attached to the bottom of the piezometer screen to

center the piezometer screen in the hole in which it is to be placed.

(b) The filter sand should be poured down the hollow stem around the riser at a rate (to be determined in the field) which will ensure a continuous flow of filter sand that will keep the hole below the auger filled as the auger is withdrawn. Withdrawal of the auger and filling the space around the piezometer tip and riser with filter sand should continue until the hole is **filled** to a point 2 to 5 feet above the top of the **piezometer** screen. Above this elevation, the space around the riser pipe may be filled with any clean uniform sand up to the top of the particular sand stratum in which the piezometer is being installed but not closer than 10 feet of the ground surface. An impervious grout seal should then be placed from the top of the sand backfill to the ground surface.

(2) *Casing method.* The hole for a piezometer may be formed by setting the casing to an elevation 1 to 2 feet deeper than the elevation of the piezometer tip. The casing may be set by a combination of rotary drilling and driving the casing. The casing should be kept filled with water, or organic drilling fluid, if necessary, to keep the bottom of the hole from "blowing." After the casing has been set to grade, it should be flushed with water or fresh drilling fluid until clear of any sand. The piezometer tip and riser pipe should then be installed and a filter sand, conforming to that specified previously, poured in around the riser at a rate (to be determined in the field) which will ensure a continuous flow of filter sand that will keep the space around the riser pipe and below the casing filled as the casing is withdrawn without "sand-locking" the casing and the riser pipe. Placement of the filter sand and withdrawal of the casing may be accomplished in steps as long as the top of the filter sand is maintained above the bottom of the casing but not so much as to "sand-lock" the riser pipe and casing. Filling the space around the piezometer tip and riser with filter sand should continue until the hole is filled to a point 2 to 5 feet above the top of the piezometer screen. An impervious grout seal should then be placed from the top of the sand backfill to the ground surface.

(3) *Rotary method.* The hole for a piezometer may be advanced by the hydraulic rotary method using water or an organic drilling fluid. After the hole has been advanced to a depth of 1 or 2 feet below the **piezometer** tip elevation, it should be flushed with clear water or clean drilling fluid, and the piezometer, filter sand, sand backfill, and grout placed as specified above for the casing method, except there will be no casing to pull.

b. Development and testing. The piezometer should be flushed with clear water and pumped after installation and then checked to determine if it is functioning

properly by filling with water and observing the rate of fall. A 10-foot minimum positive head should be maintained in the piezometer following breakdown of the drilling fluid. After at least 30 minutes have elapsed, the piezometer should be flushed with clear water and pumped. For the piezometer to be considered acceptable, it should pump at a rate of at least 2 gallons per minute, or when the piezometer is filled with water, the water level should fall approximately half the distance to the groundwater table in a time slightly less than the time given below for various

types of soil:

<i>Type of Soil in Which Piezometer Screen Is Set</i>	<i>Period of Observation minutes</i>	<i>Approximate Time of 50 Percent Fall minutes</i>
Sandy silt (>50% silt)	30	30
Silty sand (<50% silt, >12% silt)	10	5
Fine sand	5	1

If the piezometer does not function properly, it will be developed by air surging or pumping with air if necessary to make it perform properly.

CHAPTER 6

OPERATION AND PERFORMANCE CONTROL

6-1. General. *The success of a dewatering operation finally hinges on the proper operation, maintenance, and control of the system. If the system is not operated and maintained properly, its effectiveness may soon be lost. After a dewatering or pressure relief system has been installed, a full-scale pumping test should be made and its performance evaluated for adequacy or need for any modification of the system. This test and analysis should include measurement of the initial water table, pump discharge, water table in excavation, water table in wells or vacuum in header system, and a comparison of the data with the original design.*

6-2. Operation.

a. Wellpoint systems.

(1) The proper performance of a wellpoint system requires continuous maintenance of a steady, high vacuum. After the system is installed, the header line and all joints should be tested for leaks by closing all swing-joint and pump suction valves, filling the header with water under a pressure of 10 to 15 pounds per square inch, and checking the line for leaks. The next step is to start the wellpoint pump with the pump suction valve closed. The vacuum should rise to a steady 25 to 27 inches of mercury. If the vacuum on the pump is less than this height, there must be air leaks or worn parts in the pump itself. If the vacuum at the pump is satisfactory, the gate valve on the suction side of the pump may be opened and the vacuum applied to the header, with the wellpoint swing-joint valves still closed. If the pump creates a steady vacuum of 25 inches or more in the line, the header line may be considered tight. The swing-joint valves are then opened and the vacuum is applied to the wellpoints. If a low, unsteady vacuum develops, leaks may be present in the wellpoint riser pipes, or the water table has been lowered to the screen in some wellpoints so that air is entering the system through one or more wellpoint screens. One method of eliminating air entering the system through the wellpoints is to use a riser pipe 25 feet or more in length. If the soil formation requires the use of a shorter riser pipe, entry of air into the system can be prevented by partially closing the main valve between the pump and the header or by adjusting the valves in the swing connections until air entering the system is stopped. This method is commonly used for controlling air entry and is known as tuning

the system; the pump operator should do this daily.

(2) A wellpoint leaking air will frequently cause an audible throbbing or bumping in the swing-joint connection, which may be felt by placing the hand on the swing joint. The throbbing or bumping is caused by intermittent charges of water hitting the elbow at the top of the riser pipe. In warm weather, wellpoints that are functioning properly feel cool and will sweat due to condensation in a humid atmosphere. A wellpoint that is not sweating or that feels warm may be drawing air through the ground, or it may be clogged and not functioning. Likewise, in very cold weather, properly functioning wellpoints will feel warm to the touch of the hand compared with the temperature of the atmosphere. Vacuum wellpoints disconnected from the header pipe can admit air to the aquifer and may affect adjacent wellpoints. Disconnected vacuum wellpoints with riser pipes shorter than 25 feet should be capped.

(3) Wellpoint headers, swing connections, and riser pipes should be protected from damage by construction equipment. Access roads should cross header lines with bridges over the header to prevent damage to the headers or riser connections and to provide access for tuning and operating the system.

b. Deep wells. Optimum performance of a deep-well system requires continuous uninterrupted operation of all wells. If the pumps produce excessive drawdowns in the wells, it is preferable to regulate the flow from all of the wells to match the flow to the system, rather than reduce the number of units operating and thus create an uneven **drawdown** in the dewatered area. The discharge of the wells may be regulated by varying the pump speed (if other than electric power is used) or by varying the discharge pressure head by means of a gate valve installed in the discharge lines. Uncontrolled discharge of the wells may also produce excessive drawdowns within the well causing undesirable surging and uneven performance of the pumps.

c. Pumps. Pumps, motors, and engines should always be operated and maintained in accordance with the manufacturer's directions. All equipment should be maintained in first-class operating condition at all times. Standby pumps and power units in operating conditions should be provided for the system, as discussed in chapter 4. Standby equipment may be required to operate during breakdown of a pumping unit

or during periods of routine maintenance and oil change of the regular dewatering equipment. All standby equipment should be periodically operated to ensure that it is ready to function in event of a breakdown of the regular equipment. Automatic starters, clutches, and valves may be included in the standby system if the dewatering requirements so dictate. Signal lights or warning buzzers may be desirable to indicate, respectively, the operation or breakdown of a pumping unit. If control of the groundwater is critical to safety of the excavation or foundation, appropriate operating personnel should be on duty at all times. Where gravity flow conditions exist that allow the water table to be lowered an appreciable amount below the bottom of the excavation and the recovery of the water table is slow, the system may be pumped only part time, but this procedure is rarely possible or desirable. Such an operating procedure should not be attempted without first carefully observing the rate of rise of the groundwater table at critical locations in the excavations and analyzing the data with regard to existing soil formations and the status of the excavation.

d. Surface water control. Ditches, dikes, sumps, and pumps for the control of surface water and the protection of dewatering pumps should be maintained throughout construction of the project. Maintenance of ditches and sumps is of particular importance. Silting of ditches may cause overtopping of dikes and serious erosion of slopes that may clog the sumps and sump pumps. Failure of sump pumps may result in flooding of the dewatering equipment and complete breakdown of the system. Dikes around the top of an excavation to prevent the entry of surface water should be maintained to their design section and grade at all times. Any breaks in slope protection should be promptly repaired.

6-3. Control and evaluation of performance. After a dewatering or groundwater control system is installed, it should be pump-tested to check its performance and adequacy. This test should include measurement of initial groundwater or artesian water table, drawdown at critical locations in the excavation, flow from the system, elevation of the water level in the wells or vacuum at various points in the header, and distance to the "effective" source of seepage, if possible. These data should be analyzed, and if conditions at the time of test are different than those for which the system was designed, the data should be extrapolated to water levels and source of seepage assumed in design. It is important to evaluate the system as early as possible to determine its adequacy to meet full design requirements. Testing a dewatering system and monitoring its performance require the installation of piezometers and the setting up of some means

for measuring the flow from the system or wells. Pressure and vacuum gages should also be installed at the pumps and in the header lines. For multistage wellpoint systems, the installation and operation of the first stage of wellpoints may offer an opportunity to check the permeability of the pervious strata, radius of influence or distance to the source of seepage, and the head losses in the wellpoint system. Thus, from observations of the drawdown and discharge of the first stage of wellpoints, the adequacy of the design for lower stages may be checked to a degree.

a. Piezometers. The location of piezometers should be selected to produce a complete and reliable picture of the drawdown produced by the dewatering system. Examples of types of piezometers and methods of installation are given in paragraphs G-5c(6) and G-6h(2) of Appendix G. Piezometers should be located so they will clearly indicate whether water levels required by specifications are attained at significant locations. The number of piezometers depends on the size and configuration of the excavation and the dewatering system. Normally, three to eight piezometers are installed in large excavations and two or three in smaller excavations. If the pervious strata are stratified and artesian pressure exists beneath the excavation, piezometers should be located in each significant stratum. Piezometers should be installed at the edge of and outside the excavation area to determine the shape of the drawdown curve to the dewatering system and the effective source of seepage to be used in evaluating the adequacy of the system. If recharge of the aquifer near the dewatering system is required to prevent settlement of adjacent structures, control piezometers should be installed in these areas. Where the groundwater is likely to cause incrustation of well screens, piezometers may be installed at the outer edge of the filter and inside the well screen to monitor the head loss through the screen as time progresses. In this way, if a significant increase in head loss is noted, cleaning and reconditioning of the screens should be undertaken to improve the efficiency of the system. Provisions for measuring the drawdown in the wells or at the line of wellpoints are desirable from both an operation and evaluation standpoint.

b. Flow measurements. Measurement of flow from a dewatering system is desirable to evaluate the performance of the system relative to design predictions. Flow measurements are also useful in recognizing any loss in efficiency of the system due to incrustation or clogging of the wellpoints or well screens. Appendix F describes the methods by which flow measurements can be made.

c. Operational records. Piezometers located within the excavated area should be observed at least once a day, or more frequently, if the situation demands, to

ensure that the required **drawdown** is being maintained. Vacuum and gages (revolutions per minute) on pumps and engines should be checked at least every few hours by the operator as he makes his rounds. Piezometers located outside the excavated area, and discharge of the system, may be observed less frequently after the initial pumping test of the completed system is concluded. Piezometer readings, flow measurements, stages of nearby streams or the elevation of

the surrounding groundwater, and the number of wells or wellpoints operating should be recorded and plotted throughout the operation of the dewatering system. The data on the performance of the dewatering system should be continually evaluated to detect any irregular functioning or loss of efficiency of the dewatering system before the construction operations are impeded, or the excavation or foundation is damaged.

CHAPTER 7

CONTRACT SPECIFICATIONS

7-1. General. Good specifications are essential to ensure adequate dewatering and groundwater control. Specifications must be clear, concise, and complete with respect to the desired results, special conditions, inspection and control, payment, and responsibility. The extent to which specifications should specify procedures and methods, is largely dependent upon the complexity and magnitude of the dewatering problem, criticality of the dewatering with respect to schedule and damage to the work, and the experience of the probable bidders. Regardless of the type of specification selected, the dewatering system(s) should be designed, installed, operated, and monitored in accordance with the principles and criteria set forth in this manual.

7-2. Types of specifications.

a. Type A. Where dewatering of an excavation does not involve unusual or complex features and failure or inadequacy of the system would not adversely affect the safety of personnel, the schedule, performance of the work, foundation for the structure, or the completed work, the specifications should be one of the following types:

(1) **Type A-1.** A brief specification that requires the Contractor to assume full responsibility for design, installation, operation, and maintenance of an adequate system. (This type should not be used unless the issuing agency has considerable confidence in the Contractor's dewatering qualifications and has the time and capability to check the Contractor's proposal and work.)

(2) **Type A-2.** A specification that is more detailed than type A-1 but still requires the Contractor to assume the responsibility for design, installation, operation, and maintenance. (This type conveys more information regarding requirements of design and construction than type A-1 while retaining the limitations described in (1) above.)

b. Type B. Where dewatering or relief of artesian pressure is complex and of a considerable magnitude and is critical with respect to schedule and damage to the work, the specifications should be of one of the following types:

(1) **Type B-1.** A specification that sets forth in detail the design and installation of a "minimum" system that will ensure a basically adequate degree of dewatering and pressure relief but still makes the Contractor

fully responsible for obtaining the required dewatering and pressure relief as proven by a full-scale pumping test(s) on the system prior to start of excavation, and for all maintenance, repairs, and operations.

(2) **Type B-2.** A specification that sets forth in detail the design and installation of a system that has been designed to achieve the desired control of groundwater wherein the Government or Owner assumes full responsibility for its initial performance, based on a full-scale pumping test(s), but makes the Contractor responsible for maintenance and operation except for major repairs required over and beyond those appropriate to normal maintenance. (This type of specification eliminates claims and contingencies commonly added to bid prices for dewatering and also ensures that the Government gets a dewatering system that it has paid for and a properly dewatered excavation if the system has been designed and its installation supervised by qualified and experienced personnel.)

(3) **Type B-3.** A specification that sets forth the desired results making the Contractor solely responsible for design, equipment, installation procedures, maintenance, and performance, but requires that the Contractor employ or subcontract the dewatering and groundwater control to a recognized company with at least 5 years, and preferably 10 years, of experience in the management, design, installation, and operation of dewatering systems of equal complexity. The specification should also state that the system(s) must be designed by a registered professional engineer recognized as an expert in dewatering with a minimum of 5 to 10 years of responsible experience in the design and installation of dewatering systems. This type of specification should further require submittal of a brief but comprehensive report for review and approval including:

(a) A description and profile of the geology, soil, and groundwater conditions and characteristics at the site.

(b) Design values, analyses, and calculations.

(c) Drawings of the complete dewatering system(s) including a plan drawing, appropriate sections, pump and pipe capacities and sizes, power system(s), standby power and pumps, grades, filter gradation, surface water control, valving, and disposal of water.

(d) A description of installation and operational procedures.

(e) A layout of piezometers and flow measuring

devices for monitoring performance of the system(s).

(f) A plan and schedule for monitoring performance of the system(s).

(g) A statement that the dewatering system(s) has been designed in accordance with the principles and criteria set forth in this manual.

(h) The seal of the designer.

(This type of specification should not be used unless the Government or Owner has or employs someone competent to evaluate the report and design submitted, and is prepared to insist on compliance with the above.)

7-3. Data to be included in specifications. All data obtained from field investigations relating to dewatering or control of groundwater made at the site of the project should be included with the specifications and drawings or appended thereto. These data should include logs of borings; soil profiles; results of laboratory tests including mechanical analyses, water content of silts and clays, and any chemical analyses of the groundwater; pumping tests; groundwater levels in each aquifer, if more than one, as measured by properly installed and tested piezometers, and its variation with the season or with river stages; and river stages and tides for previous years if available. Borings should not only be made in the immediate vicinity of the excavation, but some borings should be made on lines out to the source of groundwater flow or to the estimated "effective" radius of influence. Sufficient borings should be made to a depth that will delineate the full thickness of any substrata that would have a bearing on the control of groundwater or unbalanced uplift pressures. (Additional information on field investigations and the scope of such are given in chap 3.) It is essential that all field or laboratory test data be included with the specifications, or referenced, and that the data be accurate. The availability, adequacy, and reliability of electric power, if known, should be included in the contract documents. The same is true for the disposal of water to be pumped from the dewatering systems. The location and ownership of water wells off the project site that might be effected by lowering the groundwater level should be shown on one of the contract drawings.

7-4. Dewatering requirements and specifications. The section of the specifications relating to dewatering and the control of groundwater should be prepared by a geotechnical engineer experienced in dewatering and in the writing of specifications, in cooperation with the civil designer for the project. The dewatering specifications may be rather general or quite detailed depending upon the type of specification to be issued as described in paragraph 7-2.

CL. *Type A specifications.*

(1) If the specification is to be of Types A-1 and A-2 described in paragraph 7-2a(1) and (2), the desired results should explicitly specify the level to which the groundwater and/or piezometric surface should be lowered; give recommended factors of safety as set forth in paragraph 4-8; require that all permanent work be accomplished in the dry and on a stable subgrade; and advise the Contractor that he is responsible for designing, providing, installing, operating, monitoring, and removing the dewatering system by a plan approved by the Contracting Officer or the Engineer. This type of specification should note the limitations of groundwater information furnished since seepage conditions may exist that were not discovered during the field exploration program. It should be made clear that the Contractor is not relieved of responsibility of controlling and disposing of all water, even though the discharge of the dewatering system required to maintain satisfactory conditions in the excavation may be in excess of that indicated by tests or analyses performed by the Government. This type of specification should not only specify the desired results but also require that the Contractor provide adequate methods for obtaining them by means of pumping from wells, wellpoint systems, cutoffs, grouting, freezing, or any other measures necessary for particular site conditions. The method of payment should also be clearly specified.

(2) Prior to the start of excavation the Contractor should be required to submit for review a proposed method for dewatering the excavation, disposing of the water, and removing the system, as well as a list of the equipment to be used, including standby equipment for emergency use. (This plan should be detailed and adapted to site conditions and should provide for around-the-clock dewatering operation.)

(3) Perimeter and diversion ditches and dikes should be required and maintained as necessary to prevent surface water from entering any excavation. The specifications should also provide for controlling the surface water that falls or flows into the excavation by adequate pumps and sumps. Seepage of any water from excavated slopes should be controlled to prevent sloughing, and ponding of water in the excavation should be prevented during construction operations. Any water encountered in an excavation for a shaft or tunnel shall be controlled, before advancing the excavation, to prevent sloughing of the walls or "boils" in the bottom of the excavation or blow-in of the tunnel face. If the flow of water into an excavation becomes excessive and cannot be controlled by the dewatering system that the Contractor has installed, excavation should be halted until satisfactory remedial measures have been taken. Dewatering of excavations for shafts, tunnels, and lagged open excavations should continue for the duration of the work to be performed in the ex-

cavations unless the tunnel or shaft has been securely lined and is safe from hydrostatic pressure and seepage.

(3) The specifications should also require that the Contractor's plan provide for testing the adequacy of the system prior to start of excavation and for monitoring the performance of the system by installing piezometers and means for measuring the discharge from the system.

b. Type B specifications.

(1) Types B-1 and B-2 specifications (para 7-2b(1) and (2)) should set forth not only the required results for dewatering, pressure relief, and surface water control, but also a detailed list of the materials, equipment, and procedures that are to be used in achieving the desired system(s). The degree of responsibility of the Contractor for dewatering should be clearly set forth for specification types B-1 and B-2 as previously stated in paragraph 7-2. With either type of specification, the Contractor should be advised that he or she is responsible for operating and maintaining the system(s) in accordance with the manufacturer's recommendation relating to equipment and in accordance with good construction practice. The Contractor should also be advised that he or she is responsible for correcting any unanticipated seepage or pressure conditions and taking appropriate measures to control such, payment for which would depend upon the type of specification and terms of payment.

(2) Type B-3 specifications (para 7-2b) should include the basic requirements set forth above for types A-1 and A-2 specifications plus the additional re-

quirements set forth for type B-3 specifications in paragraph 7-2.

7-5. Measurement and payment.

a. Payment when using types A-1 and A-2 specifications is generally best handled by a "lump sum" payment.

b. Payment when using type B-1 specifications may be based on a lump sum type, or unit prices may be set up for specific items that have been predesigned and specified with lump sum payment for operational and maintenance costs,

c. Payment when using type B-2 specifications is generally on the basis of various unit prices of such items as wells, pumps, and piping, in keeping with normal payment practices for specified work. Operation for maintenance and repairs generally should be set up as a lump sum payment with partial payment in accordance with commonly accepted percentages of work completed,

d. Payment when using type B-3 specifications would generally be based on a lump sum type of payment.

e. Payment for monitoring piezometers and flow measuring devices is generally made in keeping with the method of payment for the various types of dewatering specifications described above,

7-6. Examples of dewatering specifications. Examples of various types of specifications described in paragraph 7-2, based on specifications actually issued and accomplished in practice, are included in appendix G.

APPENDIX A
REFERENCES

Government Publications

Department of Defense

Military Standard
MIL-STD-619B

Unified Soil Classification System for Roads, Airfields, Embankments, and Foundations

Departments of the Army and the Air Force

TM 5-818-1/AFM 88-3, Chap. 7

Soils and Geology: Procedures for Foundation Designs of Buildings and Other Structures (Except Hydraulics Structures)

TM 5-818-4/AFM 88-5, Chap. 5
TM 5-818-6/AFM 88-32

Soils and Geology: Backfill for Subsurface Structures Grouting Methods and Equipment

Department of the Navy

NAVFAC DM7.1
NAVFAC DM7.3

Soil Mechanics
Deep Stabilization and Grouting

Nongovernment Publications

American Society for Testing and Materials (ASTM), 1916 Race Street, Philadelphia, PA 19103

A 108431
A 743-83

Steel Bars, Carbon, Cold-Finished, Standard Quality Castings, Iron-Chromium, Iron-Chromium-Nickel, Nickel-Base, Corrosion Resistant for General Application

NAVAC DM7.2

BIBLIOGRAPHY

Foundations and Earth Structures

APPENDIX B

NOTATIONS

- A Area of filter through which seepage is passing, drainage area, radius of a circular group of wells; area of permeability test sample, area of entrance section of pipe in measuring flow through a venturi meter or with a **Pitot** tube, or area of stream of water at end of pipe in jet-flow measurement
- AD Cross-section area of sand drain
- A_e Equivalent radius of a group of wells
- A_2 Area of orifice
 - a Spacing of wells or wellpoints
- B Distance between two lines of wells, length of weir crest, or circumference of a vertical pipe in fountain flow calculations
 - b Width of drainage slot, or end dimension of a rectangular drainage slot
- b_1 Half width of rectangular array of wells
- b_2 Half length of rectangular array of wells
- C Coefficient for friction loss in pipes; coefficient for empirical relation of D_{10} versus k ; coefficient for empirical relation of k versus R ; calibrated coefficient of discharge in measuring flow through a venturi meter or orifice; coefficient for measuring flow with a **Pitot** tube; or center of a circular group of wells
- C_1, C_2 Coefficients for gravity flow to two slots from two-line sources
- C_w Weighted creep ratio for piping
- $\bar{C}_x, \Delta c$ Factors for **drawdown** in the vicinity of a gravity well
 - c Coefficient of runoff
- D Thickness of homogeneous isotropic aquifer, or inside diameter of a discharge pipe
- \bar{D} Thickness of equivalent homogeneous isotropic aquifer
- D_{10} Effective grain size
 - d Thickness of a pervious stratum, or pressure tap diameter
- d_1 Pipe diameter
- d_2 Orifice diameter
- λ Transformed thickness of homogeneous, isotropic pervious stratum
- E Electrical potential difference or voltage
- E_A Extra-length factor
- EAF Effective area factor
- F, F_p Factor for computing **drawdown** at any point due to a group of wells with circular source of seepage, or freeboard
- F', F'_p Factor for computing **drawdown** at any point due to a group of wells with line source of seepage
- F_B Factor for computing **drawdown** midway between end wells of a line of wells with a circular source of seepage
- F_B Factor for computing **drawdown** midway between end wells of a line of wells with a line source of seepage
- FS Factor of safety
- F_c Factor for computing **drawdown** at center of a group of wells with circular source of seepage
- F'_c Factor for computing **drawdown** at center of a group of wells with line source of seepage
- F_m Factor for computing **drawdown** at a well m in a two-line well array with a circular source of seepage
- F_w Factor for computing **drawdown** at a well in a group of wells with circular source of seepage
- F'_w Factor for computing **drawdown** at a well in a group of wells with line source of seepage
- G Correction factor for a partially penetrating well from **Kozeny's** formula or **Muskat's** formula
- GWT Groundwater table or level
 - g Acceleration of gravity, 32.2 feet per second squared
- H Height of water table (initial) or piezometric surface, or crest height in fountain flow measurement; gravity head

- H' Drawdown or head differential, or residual drawdown after a pump test
- H'' Drawdown expressed as $H^2 - H_0^2$
- H_a Head dimension in the measurement of flow with aParshall flume
- H_c Average head loss in header pipe to pump intake
- H_e Friction head loss in screen entrance or filter and screen entrance
- H_r Friction head loss in riser pipe and connections
- H_s Friction head loss in well screen
- H_v Velocity head loss in well
- H_w Total hydraulic head loss in well or wellpoint
- H₁ Distance from bottom of sheet pile or cutoff wall to impervious boundary
- h Head at a specific point P, head on permeability test sample in constant head permeability test; final head on permeability test sample in falling head permeability test; pressure drop across an orifice; observed head on crest in weir flow measurement; or head at a specific time during a pump test
- h' Height of free discharge above water level in a gravity well
- H_c Head at center of a group of wells
- h_D Maximum head landward from a drainage slot or line of wells, or maximum head between two slots or lines of wells
- h_e Head in an artesian drainage slot, average head at a line of wells, or height of bottom of excavation in computing the creep ratio
- h_m Head midway between wells, or height of mercury for pipe orifice flow measurement
- h_o Head in a gravity drainage slot or at equivalent drainage slot simulating a line of wellpoints or sand drains, or initial head on permeability test sample in the falling heat permeability test
- h_p Head at point P
- h_s Height of free discharge above water level in drainage slot
- h_v Velocity head in measuring flow with aPitot tube
- h_w Head at well, wellpoint, or sand drain
- h_{ws} Wetted screen length
- h_{w(p)} Head in a wellpoint that can be produced by the vacuum of a wellpoint pump
- I Electric current or rate of flow
- i Hydraulic gradient of seepage, well number, intensity of rainfall
- i_e Electrical gradient between electrodes
- j Drawdown at any well
- K Constant used in jet-flow calculations
- k Coefficient of permeability of homogeneous isotropic aquifer
- \bar{k} Transformed coefficient of permeability
- k_a Coefficient of permeability for the flow of air
- k_D Vertical coefficient of permeability of a sand drain
- k_e Coefficient of electroosmotic permeability
- \bar{k}_e Effective permeability of transformed aquifer
- k_h Horizontal coefficient of permeability
- k_v Vertical coefficient of permeability
- L Distance from drainage slot, well, or line of wells or wellpoints to the effective source of seepage, length of permeability test sample, or seepage length through which Ah acts in determining a seepage gradient
- L_G Distance from drainage slot to change from artesian to gravity flow
- L_J Distance from well j to source of seepage
- ℓ Half the distance between two parallel drainage slots or lines of wells; long dimension of a rectangular drainage slot, or number of strata penetrated by a well in calculating effective well screen penetration
- \bar{W}
- M Height of pump intake above base of aquifer
- MSL Mean sea level
- N_e Number of equipotential drops in a flow net
- N_f Number of flow channels in a flow net
- n Number of wells in system or group, or porosity, number of strata in an aquifer for transformed section calculations, or number of concentric rings in measuring flow with aPitot tube
- n_e Number of equipotential drops from seepage exit to point P

- P Point at which head is computed, or factor for **drawdown** in the vicinity of a gravity well
- \bar{p} Mean absolute pressure inflow system
- p_1 Absolute atmospheric pressure
- p_2 Absolute air pressure at line of vacuum wells
- Q Rate of flow to a fully penetrating drainage slot per unit length of slot, capacity, or rate of pumping, or rate of surface water runoff
- Q_a Rate of flow of air
- Q_{a-vp} Rated capacity of vacuum pump at atmospheric pressure
- Q_D Rate of flow to a sand dram
- Q_e Flow to well in an electroosmotic drainage system
- Q_P Total surface water pump capacity
- Q_p Rate of flow to a partially penetrating drainage slot per unit length of slot
- $Q_p(T)$ Total flow to a wellpoint system
- Q_T Total flow to a dewatering system
- Q_w Flow to a well or wellpoint
- Q'_w Flow to an observation well
- Q_{wi} Flow to well i
- Q_{wj} Flow to well j
- Q_{wp} Flow to a partially penetrating artesian well
- q Rate of flow, or flow per unit length of section flow net
- q_c Limiting flow into a filter or well screen
- R Radius of influence of well, rainfall for assumed storm, or ratio of entrance to throat diameter in measuring flow through a venturi meter
- \bar{R} Distance from well to change from artesian to gravity flow
- R_i Radius of influence of well i
- R_j Radius of influence of well j
- r Distance from well to point P, or distance from a test well to an observation piezometer
- r' Distance from image well to point P
- r_i Distance from well i to point P
- r_{ij} Distance from well i to well j
- r_w Radius (effective) of a well
- r_{wj} Radius (effective) of well j
- S Coefficient of storage, the volume of water an aquifer will release from (or take into) storage per unit of surface area per unit change in head. (For *artesian* aquifers, S is equal to the water forced from storage by compression of a column of the aquifer by the additional load created by lowering the artesian pressure in the aquifer by pumping or drainage. For *gravity flow* aquifers, S is equal to the specific yield of the material being dewatered plus the water forced from the saturated portion of the aquifer by the increased surcharge caused by lowering the groundwater table.)
- S' Extrapolated S value used in computations for nonequilibrium gravity flow
- S_i Distance from point P to image well i
- S_{ij} Distance from image well i to well j
- S_y Specific yield of aquifer (volume of water that can be drained by gravity from a saturated unit volume of material)
- s Height of bottom of well above bottom of aquifer
- T Duration of rainfall, coefficient of transmissibility in square feet per minute (the coefficient of permeability k multiplied by the aquifer thickness D), or thickness of less pervious strata overlying a more pervious stratum
- T' Coefficient of transmissibility in gallons per day per foot width
- t Depth of water in well, or elapsed pumping time
- \bar{t} Time for cone of **drawdown** to reach an impermeable boundary or a source of seepage
- t' Elapsed pumping time since pump started
- t'' Elapsed time since pump stopped
- t_0 Time at zero **drawdown** or at start of pump test
- u Argument of W(u), a well function
- V Volume of water in permeability test, volume of sample in specific yield test, velocity, or vacuum at pump intake

- \bar{V} Volume of sump storage
- V_R Volume of surface water runoff
- v Velocity at center of concentric rings of equal area in measuring flow with a Pitot tube
- V_y Volume of water drained in specific yield test
- W Penetration of a drainage well, slot, or cutoff wall in a homogeneous isotropic aquifer, penetration of a drainage well or slot required to obtain an effective penetration of \bar{W} in a stratified aquifer, distance between water table in a cofferdammed area and base of the sheet piling or cutoff wall, or size of flume in the measurement of flow with a Parshall flume
- W Effective depth of penetration of a drainage slot or well into aquifer
- $W(u)$ Exponential integral termed a "well function"
- w_t Actual well penetration in strata l in calculating effective well-screen penetration \bar{W}
- x Length of a drainage slot, distance from center line of excavation to sheet pile or cutoff wall, or distance along axis of a discharge pipe to a point in the stream in jet-flow measurement
- y Distance from drainage slot to a specific line, actual vertical dimension in an anisotropic stratum, or distance perpendicular to the axis of a discharge pipe to a point in the stream in jet-flow measurement
- \bar{y} Transformed vertical dimension in an anisotropic stratum
- z Depth of soil stabilized by electroosmosis, or height of crest above bottom of approach channel in weir-flow measurement
- Γ Gamma function for determining G
- γ_w Unit weight of water
- Δh Change in piezometric head for a particular seepage length; drawdown; artesian head above bottom of slope or excavation
- Δh_D Maximum head landward from a line of wells above head at wells
- Δh_m Head midway between wells above that at a well
- Δh_w Drawdown at well in a line of wells below head h_e at an equivalent drainage slot
- $\Delta H'$ Change in drawdown during pump test between two different pumping rates
- Δp Pressure differential
- Δs Drawdown in feet per cycle of (log) time-drawdown curve in pump test
- $\Delta s'$ Residual drawdown in feet per cycle of (log) t'/t''
- γ'_m Submerged unit weight of soil
- θ_a Uplift factor for artesian wells or wellpoints
- θ_m Midpoint uplift factor for artesian wells or wellpoints
- λ Extra-length coefficient for flow to a partially penetrating drainage slot
- μ_a Absolute viscosity of air
- μ_w Absolute viscosity of water
- ρ Specific resistance of electrolyte
- \S Geometric shape factor (dimensionless)

APPENDIX C

FIELD PUMPING TESTS

C-1. General. There are two basic types of pumping tests: *equilibrium* (steady-state flow) and *nonequilibrium* (transient flow).

a. Equilibrium-type test. When a well is pumped, the water discharged initially comes from aquifer storage adjacent to the well. As pumping continues, water is drawn from an expanding zone until a state of equilibrium has been established between well discharge and aquifer recharge. A state of equilibrium is reached when the *zone of influence* has become sufficiently enlarged so that: natural flow into the aquifer equals the pumping rate; a stream or lake is intercepted that will supply the well (fig. C-1); or vertical recharge from precipitation on the area above the zone of influence equals the pumping rate. If a well is pumped at a constant rate until the zone of drawdown has become *stabilized*, the coefficient of permeability of the aquifer can be computed from *equilibrium* formulas subsequently presented.

b. Nonequilibrium-type test.

(1) In this type of test, the value of k is computed from a relation between the rate of pumping Q , drawdown H' at a point P near the well, distance from the well to the point of drawdown measurement r , coefficient of storage of the aquifer S , and elapsed pumping time t . This relation permits determination of k from aquifer performance, while water is being drawn from storage and before stabilization occurs.

(2) Nonequilibrium equations are directly applicable to confined (artesian) aquifers and may also be used with limitations to unconfined aquifers (gravity flow conditions). These limitations are related to the percentage of drawdown in observation wells related to the total aquifer thickness. Nonequilibrium equations should not be used if the drawdown exceeds 25 percent of the aquifer thickness at the wall. Little error is introduced if the percentage is less than 10.

c. Basic assumptions.

(1) Both *equilibrium* and *nonequilibrium* methods for analyzing aquifer performance are generally based on the assumptions that:

(a) The aquifer is homogeneous and isotropic.

(b) The aquifer is infinite in extent in the horizontal direction from the well and has a constant thickness.

(c) The well screen fully penetrates the pervious formation.

(d) The flow is laminar.

(e) The initial static water level is horizontal.

(2) Although the assumptions listed above would seem to limit the analysis of pumping test data, in reality they do not. For example, most pervious formations do not have a constant k or transmissibility T ($T = k \times$ aquifer thickness), but the average T can readily be obtained from a pumping test. Where the flow is artesian, stratification has relatively little im-

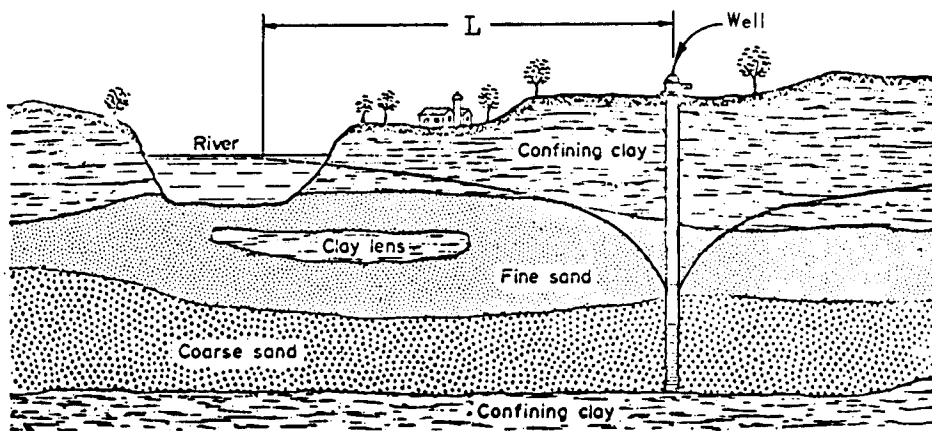

(Courtesy of UOP Johnson Division)

Figure C-1. Seepage into an aquifer from an adjacent river.

portance if the well screen fully penetrates the aquifer; of course, the derived permeability for this case is actually k_h . If the formation is stratified and $k_h \geq k_v$, and the flow to the well is gravity in nature, the computed permeability k would be $<k_h$ and $>k_v$.

(3) Marked changes of well or aquifer performance during a nonequilibrium test indicate that the physical conditions of the aquifer do not conform to the assumptions made in the development of the formula for nonsteady flow to a well. **However**, such a departure does not necessarily invalidate the test data; in fact, analysis of the change can be used as a tool to better determine the flow characteristics of the aquifer.

C-2. Pumping test equipment and procedures. Determination of k from a pumping test requires: (a) installation of a test well, (b) two, and preferably more, observation wells or piezometers, (c) a suitable pump, (d) equipment for sounding the well

and adjacent piezometers, and (e) some means for accurately measuring the flow from the well.

a. *Test and observation wells.* The test well should fully penetrate the aquifer to avoid uncertainties involved in the analysis of partially penetrating wells, and the piezometers should be installed at depths below any anticipated **drawdown** during the pumping test. The number, spacing, and arrangement of the observation wells or piezometers will depend on the characteristics of the aquifer and the geology of the area (figs. C-2 and C-3). Where the test well is located adjacent to a river or open water, one line of piezometers should be installed on a line perpendicular to the river, one line parallel to the river, and, if possible, one line away from the river. At least one line of piezometers should extend 500 feet or more out from the test well. The holes made for installing piezometers should be logged for use in the analysis of the test. The distance from the test well to each piezometer should be **meas-**

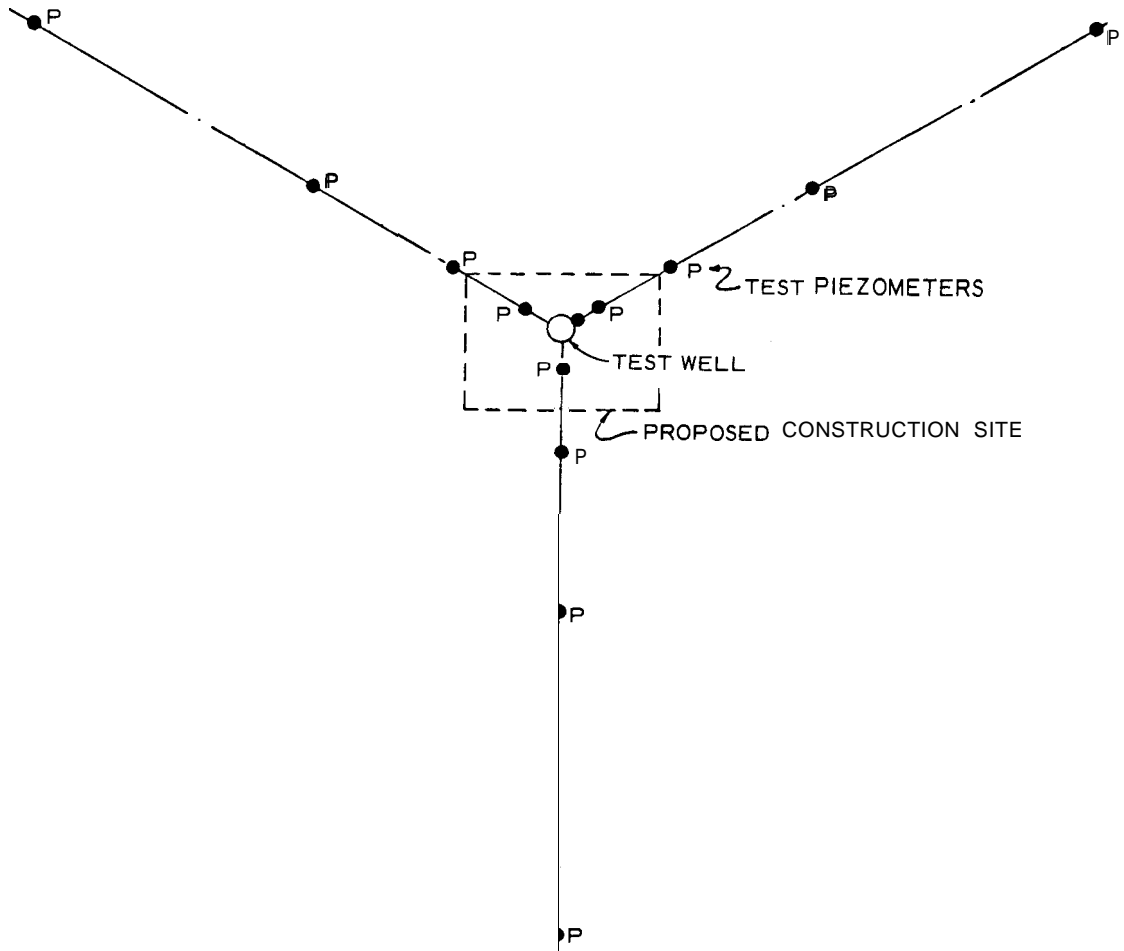

U. S. Army Corps of Engineers

Figure C-2. Layout of piezometers for a pumping test.

ured, and the elevation of the top of each accurately determined. Each piezometer should be capped with a vented cap to keep out dirt or trash and to permit change in water level in the piezometer without creating a partial vacuum or pressure. The test well and piezometers should be carefully installed and developed, and their performance checked by individual pumping or falling head tests in accordance with the procedures discussed in chapter 5 of the main text.

b. Pumps.

(1) The test pump should be a centrifugal, or more preferably, a turbine or submersible pump. It should be capable of lowering the water level in the well at least 10 feet or more depending upon the characteristics of the formation being tested. The pump should preferably be powered with an electric motor, or with an engine capable of operating continuously for the duration of the test. The pump discharge line should be equipped with a valve so that the rate of discharge can be accurately controlled. At the beginning of the test, the valve should be partially closed so that back

pressure on the pump can be varied as the test progresses to keep the rate of flow constant.

(2) During a pumping test, it is imperative that the rate of pumping be maintained constant. Lowering of the water level in the well will usually cause the pumping rate to decrease unless the valve in the discharge line is opened to compensate for the additional head or lift created on the pump. If the pump is powered with a gas or diesel engine, changes in temperature and humidity of the air may affect appreciably the operation of the engine and thus cause variations in the pumping rate. Variations in line voltage may similarly affect the speed of electric motors and thus the pumping rate. Any appreciable variation in pumping rate should be recorded, and the cause of the variation noted.

(3) The flow from the test well must be conveyed from the test site so that recharge of the aquifer from water being pumped does not occur within the zone of influence of the test well.

c. Flow and drawdown measurements.

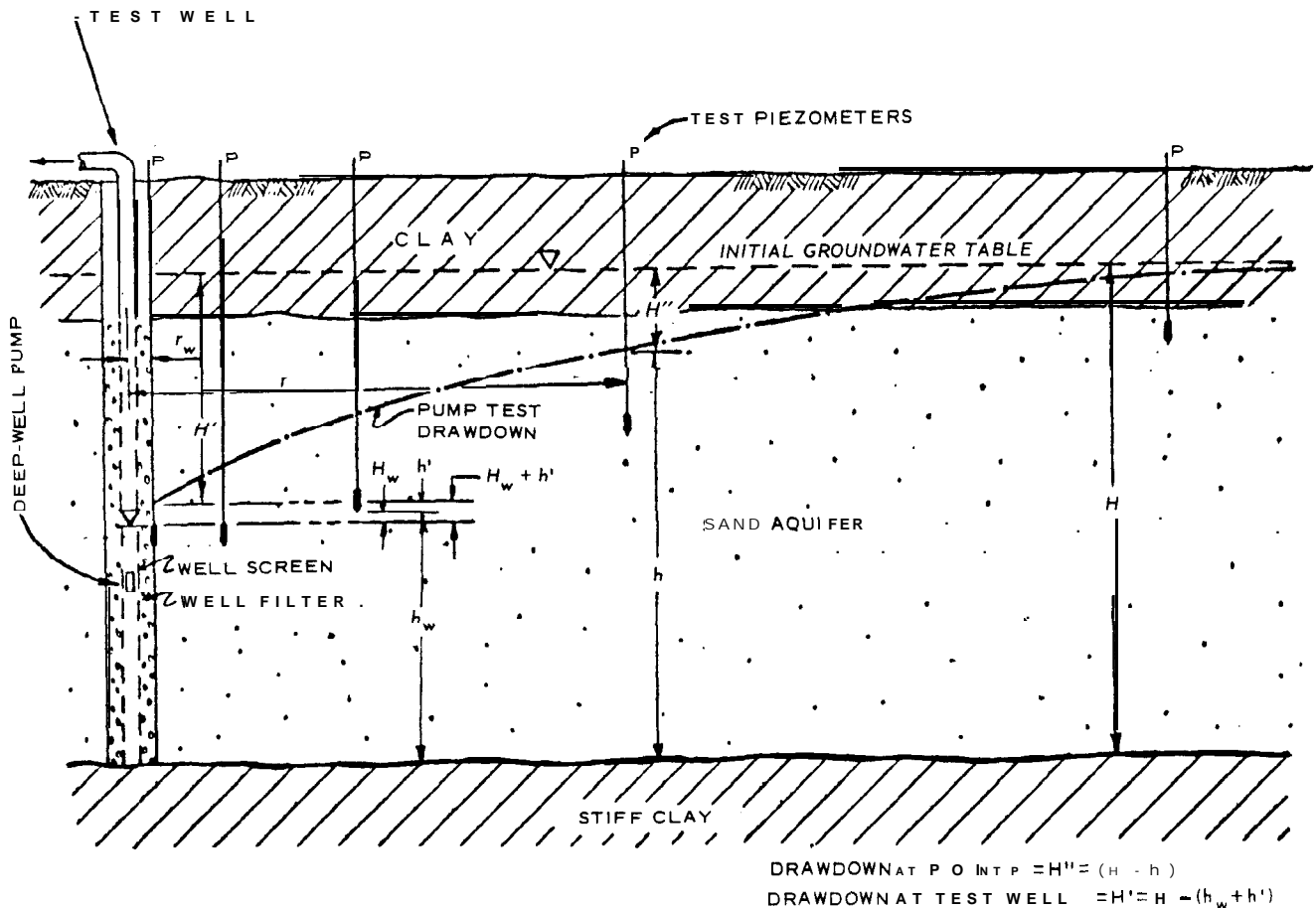

U. S. Army Corps of Engineers

Figure C-3. Section of well and piezometers for a pumping test with gravity flow near well.

(1) The discharge from the well can be measured by means of an orifice, pitometer, venturi, or flowmeter installed in the discharge pipe, or an orifice installed at the end of the discharge pipe, as described in appendix G. The flow can also be estimated from the jet issuing from a smooth discharge pipe, or measured by means of a weir or flume installed in the discharge channel. For such flow measurements, appropriate consideration must be given to the pipe or channel hydraulics in the vicinity of the flow-measuring device. Formulas, graphs, and tables for measuring flow from a test well are given in appendix G.

(2) In thick aquifers, or in deposits where the material varies with depth, it may be desirable to de-

termine the permeability of the various strata of the formations in order to better determine the required length and depth of well screens of wellpoints for the design of a dewatering or drainage system. This permeability can be determined by measuring the vertical flow within the well screen at various levels with a flowmeter. The flow from the various strata can be obtained by taking the difference in flow at adjacent measuring levels; the flow-meter, equipped with a centering device, is placed in the well before the pump is installed. Typical data obtained from such well-flow measurements in a test well are shown in figure C-4. These data can be used to compute the coefficient of permeability of the various strata tested as shown, The

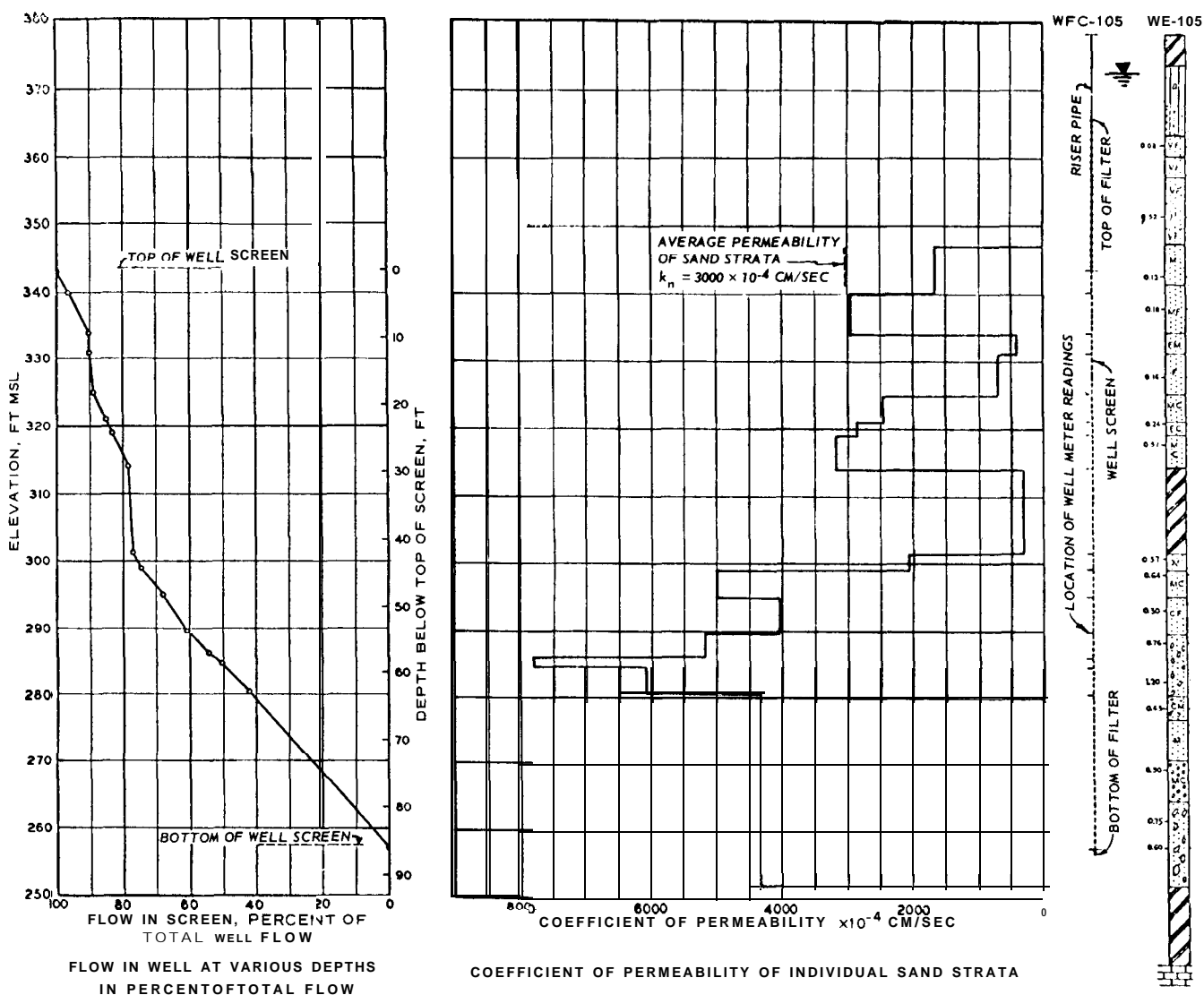

U. S. Army Corps of Engineers

Figure C-4. Coefficient of permeability k_h of various strata determined from a pumping test and flow measurements in the well screen.

correlation between D_{10} and k_h shown in figure C-4 was based on laboratory sieve analyses and on such well-flow tests.

d. General test procedures.

(1) Before a **pump** test is started, the test well should be pumped for a brief period to ensure that the pumping equipment and measuring devices are functioning properly and to determine the approximate valve and power settings for the test. The water level in the well and all observation piezometers should be observed for at least 24 hours prior to the test to determine the initial groundwater table. If the groundwater prior to the test is not stable, observations should be continued until the rate of change is clearly established; these data should be used to adjust the actual test **drawdown** data to an approximate equilibrium condition for analysis. Pumping of any wells in the vicinity of the test well, which may influence the test results, should be regulated to discharge at a constant, uninterrupted rate prior to and during the complete test.

(2) **Drawdown** observations in the test well itself are generally less reliable than those in the **piezometers** because of pump vibrations and momentary variations in the pumping rate that cause fluctuations in the water surface within the well. A sounding tube with small perforations installed inside the well screen can be used to dampen the fluctuation in the water level and improve the accuracy of well soundings. All observations of the groundwater level and pump dis-

charge should include the exact time that the observation was made.

(3) As changes in barometric pressure may cause the water level in test wells to fluctuate, the barometric pressure should be recorded during the test.

(4) When a pumping test is started, changes in water levels occur rapidly, and readings should be taken as often as practicable for certain selected piezometers (e.g., $t = 2, 5, 8, 10, 15, 20, 30, 4.5,$ and 60 minutes) after which the period between observations may be increased. Sufficient readings should be taken to define accurately a curve of water level or **drawdown** versus (log) elapsed pumping time. After pumping has stopped, the rate of groundwater-level recovery should be observed. Frequently, such data are important in evaluating the performance and characteristics of an aquifer.

C-3. Equilibrium pumping test.

a. In an equilibrium type of pumping test, the well is pumped at a constant rate until the **drawdown** in the well and piezometers becomes stable.

b. A typical timedrawdown curve for a piezometer near a test well is plotted to an arithmetical scale in figure C-5 and to a **semilog** scale in figure C-6. (The computations in fig C-6 are discussed subsequently.) Generally, a **time-drawdown** curve plotted to a **semilog** scale becomes straight after the first few minutes of pumping. If true equilibrium conditions are established, the **drawdown** curve will become horizontal.

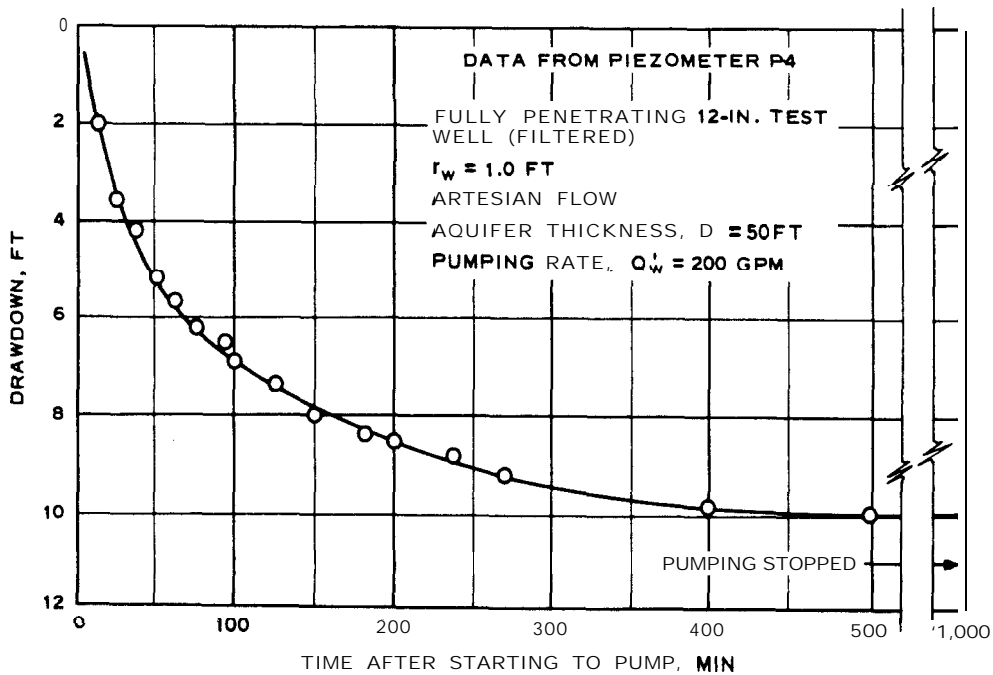

(Courtesy of UOP Johnson Division)

Figure C-5. Drawdown in an observation well versus pumping time (arithmetical scale).

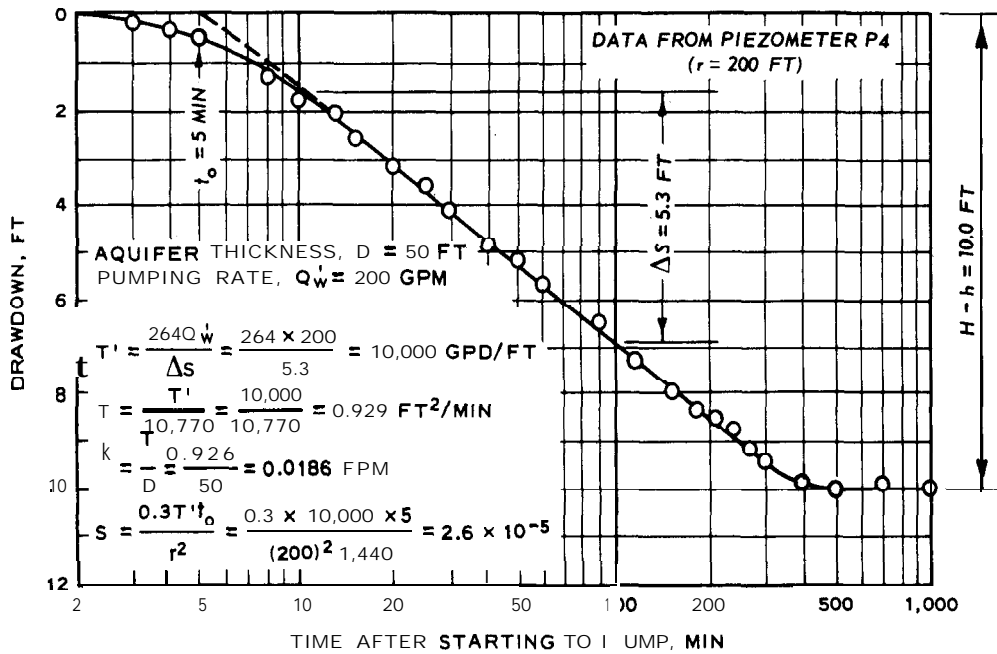

Figure C-6. Drawdown in an observation well versus pumping time (semilog scale).

The drawdown measured in the test well and adjacent observation wells or piezometers should always be plotted versus (log) time during the test to check the performance of the well and aquifer. Although the example presented in figure C-6 shows stabilization to have essentially occurred after 500 minutes, it is considered good practice to pump artesian wells for 12 to 24 hours and to pump test wells where gravity flow conditions exist for 2 or 3 days.

c. The drawdown in an artesian aquifer as measured by piezometers on a radial line from a test well is plotted versus (log) distance from the test well in figure C-7. In a homogeneous, isotropic aquifer with artesian flow, the drawdown (H-h) versus (log) distance from the test well will plot as a straight line when the flow in the aquifer has stabilized. The drawdown H^2-h^2 versus (log) distance will also plot as a straight line for gravity flow. However, the drawdown in the well may be somewhat greater than would be indicated by a projection of this straight line to the well because of well entrance losses and the effect of a "free" flow surface at gravity wells. Extension of the drawdown versus (log) distance line to zero drawdown indicates the effective source of seepage or radius of influence R, beyond which no drawdown would be produced by pumping the test well (fig. C-7).

d. For flow from a circular source of seepage, the coefficient of permeability k can be computed from the formulas for fully penetrating wells.

Artesian Flow.

$$Q_w = \frac{2\pi kD(H-h)}{\ln(R/r)} \tag{C-1}$$

Gravity Flow,

$$Q_w = \frac{\pi k(H^2-h^2)}{\ln(R/r)} \tag{C-2}$$

where

- Q_w = flow from the well
- D = aquifer thickness
- H = initial height of groundwater table (GWT)
- h = height of GWT at (H-h) or (H²-h²) = drawdown at distance r from well
- R = radius of influence

An example of the determination of R and k from an equilibrium pumping test is shown in figure C-7.

e. For combined artesian-gravity flow, seepage from a line source and a partially penetrating well, the coefficient of permeability can be computed from well-flow formulas presented in chapter 4.

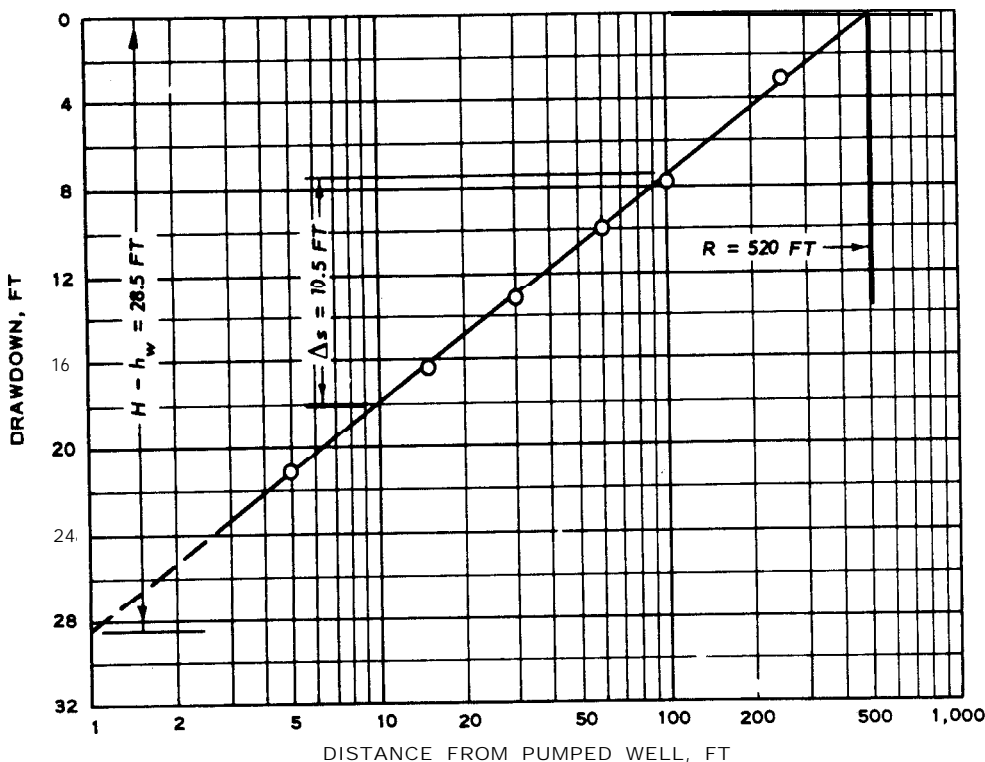

NOTE: DRAWDOWNS PLOTTED WERE MEASURED AFTER GROUNDWATER TABLE HAD STABILIZED.

EXAMPLE: FULLY PENETRATING 12-IN. TEST WELL (FILTERED), $r_w = 1.0$ FT
 ARTESIAN FLOW
 AQUIFER THICKNESS, $D = 50$ FT
 PUMPING RATE, $Q_w' = 200$ GPM
 PUMPING PERIOD $\approx 1,000$ MIN

$$k = \frac{Q_w' \ln(R/r_w)}{2\pi D (H - h_w)} = \frac{200 \ln(520/1)}{7.5 (2\pi) (50) (28.5)} = 0.0189 \text{ FPM}$$

(Courtesy of UOP Johnson Division)

Figure C-7. Drawdown versus distance from test well.

C-4. Nonequilibrium pumping test.

a. *Constant discharge tests.* The coefficients of transmissibility T , permeability k , and storage S of a homogeneous, isotropic aquifer of infinite extent with no recharge can be determined from a *nonequilibrium* type of pumping test. Average values of S and T in the vicinity of a well can be obtained by measuring the **drawdown** with time in one or more piezometers while pumping the well at a known constant rate and analyzing the data according to methods described in (1), (2), and (3) below.

(1) *Method 1.* The formula for nonequilibrium

flow can be expressed as

$$H - h = \frac{1150_w W(u)}{T'} \tag{C-3}$$

where

- $H - h$ = drawdown at observation piezometer, feet
- Q_w' = well discharge, gallons per minute
- $W(u)$ = exponential integral termed a "well function" (see table C-1)
- T' = coefficient of transmissibility, gallons per day per foot width

and

$$u = \frac{1.87r^2S}{T't} \tag{C-4}$$

Table C-1. Values Of $W(u)$ for values of u .

u	1.0	2.0	3.0	4.0	5.0	6.0	7.0	8.0	9.0
$\times 1$	0.219	0.049	0.013	0.0038	0.0011	0.00036	0.000~2	0.000038	0.0000~2
$\times 10^{-1}$	1.82	1.22	0.91	0.70	0.56	0.45	0.37	0.31	0.26
$\times 10^{-2}$	4.04	3.35	2.96	2.68	2.47	2.30	2.15	2.03	1.92
$\times 10^{-3}$	6.33	5.64	5.23	4.95	4.73	4.54	4.39	4.26	4.14
$\times 10^{-4}$	8.63	7.94	7.53	7.25	7.02	6.84	6.69	6.55	6.44
$\times 10^{-5}$	10.94	10.24	9.84	9.55	9.33	9.14	8.99	8.86	8.74
$\times 10^{-6}$	i 3.24	i 2.55	12.14	11.85	i i. 63	i i. 45	i i. 29	11.16	11.04
$\times 10^{-7}$	i 5.54	14.85	14.44	14.15	i 3.93	i 3.75	13.60	13.46	i 3.34
$\times 10^{-8}$	17.84	17.15	16.74	i 6.46	i 6.23	16.05	15.90	15.76	15.65
$\times 10^{-9}$	20.15	19.45	19.05	18.76	18.54	18.35	18.20	18.07	17.95
$\times 10^{-10}$	22.45	21.76	21.35	21.06	20.84	20.66	20.50	20.37	20.25
$\times 10^{-11}$	24.75	24.06	23.65	23.36	23.14	22.96	22.81	22.67	22.55
$\times 10^{-12}$	27.05	26.36	25.96	25.67	25.44	25.26	25.11	24.97	24.86
$\times 10^{-13}$	29.36	28.66	28.26	27.97	27.75	27.56	27.41	27.28	27.16
$\times 10^{-14}$	31.66	30.97	30.56	30.27	30.05	29.87	29.71	29.58	29.46
$\times 10^{-15}$	33.96	33.27	32.86	32.58	32.35	32.17	32.02	31.88	31.76

From "Ground Water Hydrology" by D. K. Todd, 1959, Wiley & Sons, Inc. Used with permission of Wiley & Sons, Inc., and U.S. Coast & Geodetic Survey Water Supply Paper 887.

where

r = distance from test well to observation piezometer, feet

s = coefficient of storage

t' = elapsed pumping time in days

The formation constants can be obtained approximately from the pumping test data using a graphical method of superposition, which is outlined below.

Step 1. Plot $W(u)$ versus u on log graph paper, known as a "type-curve," using table C-1 as in figure C-8.

Step 2. Plot drawdown ($H-h$) versus r^2/t' on log graph paper of same size as the type-curve in figure C-8.

Step 3. Superimpose observed data curve on type-curve, keeping coordinates axes of the two curves parallel, and adjust until a position is found by trial whereby most of the plotted data fall on a segment of the type-curve as in figure C-8.

Step 4. Select an arbitrary point on coincident

segment, and record coordinates of matching point (fig. C-8).

Step 5. With value of $W(u)$, u , $H-h$, and r^2/t' thus determined, compute S and T' from equations (C-3) and (C-4).

Step 6. T and k from the following equations:

$$T = \frac{T'}{10,770} \quad (\text{square feet per minute}) \quad (C-5)$$

$$k = \frac{T'}{10,770D} \quad (\text{feet per minute}) \quad (C-6)$$

(2) **Method 2.** This method can be used as an approximate solution for nonequilibrium flow to a well to avoid the curve-fitting techniques of method 1 by using the techniques outlined below.

Step 1. Plot time versus drawdown on semilog graph as in figure C-9.

Step 2. Choose an arbitrary point on time-drawdown curve, and note coordinates t and $H-h$.

Step 3. Draw a tangent to the time-drawdown

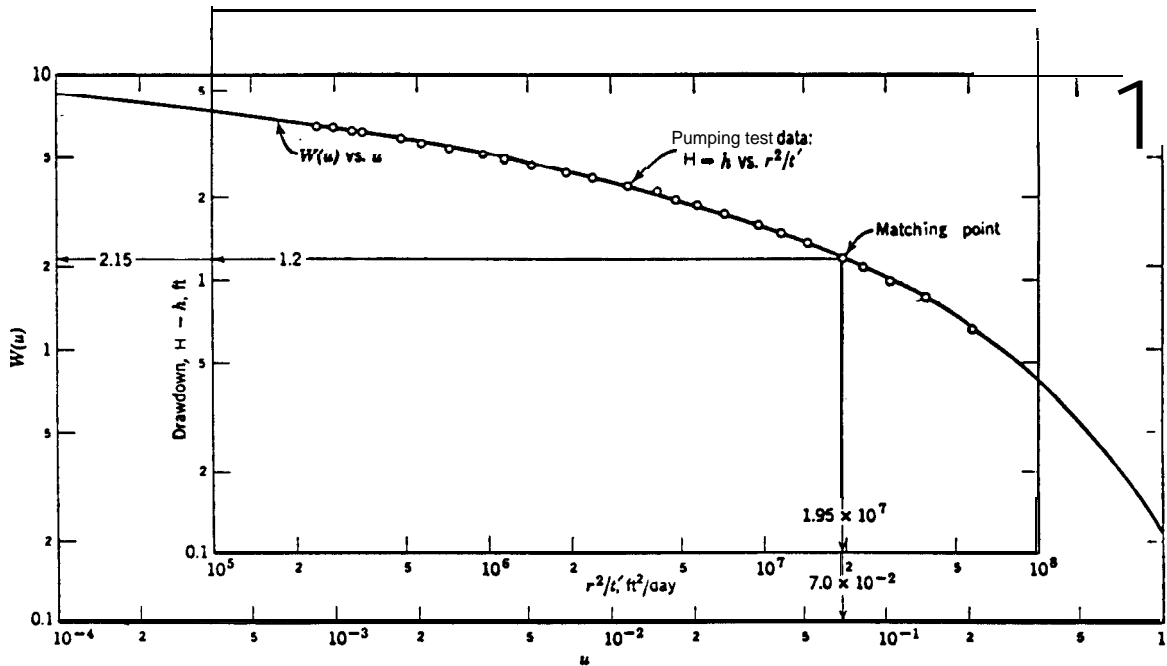

EXAMPLE: $Q'_w = 500$ GPM
 $r = 200$ FT

$$T' = \frac{115 Q'_w W(u)}{H-h} = \frac{115(500)(2.15)}{1.2} = 103,000 \text{ GPD/FT}$$

$$S = \frac{(7.0 \times 10^{-2}) (103,000)}{1.97 r^2/t'} = \frac{72,100}{1.87(1.95 \times 10^7)} = 1.98 \times 10^{-3}$$

(From "Ground Water Hydrology" by D. K. Todd, 1959, Wiley & Sons, Inc. Used with permission of Wiley & Sons, Inc.)

Figure C-8. Method 1 (Superposition) for solution of the nonequilibrium equation.

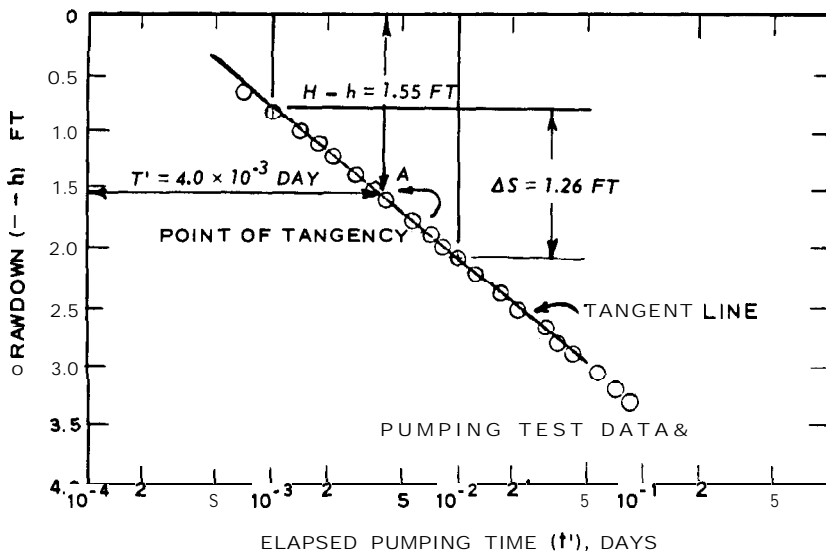

EXAMPLE: $Q_w' = 500$ GPM
 DISTANCE TO OBSERVATION WELL, $r = 200$ FT
 AT POINT A: $t' = 4.0 \times 10^{-3}$ DAY
 $H - h = 1.55$ FT
 TANGENT THROUGH A: $\Delta S = 1.26$ FT/LOG CYCLE OF PUMPING TIME IN DAYS
 THEN $F(u) = \frac{H - h}{\Delta S} = \frac{1.55}{1.26} = 1.23$ [SEE FIG. C-10 FOR $F(u)$]
 $T' = \frac{115 Q_w' W(u)}{i-h} = \frac{115(500)(2.72)}{1.55} = 101,000$ GPD/FT
 $S = \frac{T' t' u}{1.87 r^2} = \frac{101,000 (4.0 \times 10^{-3}) (0.038)}{1.87(200)^2} = 2.05 \times 10^{-4}$

(Modified from "Ground Water Hydrology" by D.K. Todd, 1959, Wiley & Sons, Inc. Used with permission of Wiley & Sons, Inc.)

Figure C-9. Method 2 for solution of the nonequilibrium equation.

curve through the selected point, and determine Δs , the drawdown in feet per log cycle of time.

Step 4. Compute $F(u) = H - h/\Delta s$, and determine corresponding $W(u)$ and u from figure C-10.

Step 5. Determine the formation constants by equations (C-3) and (C-4).

(3) Method 3. This method can be used as an approximate solution for nonequilibrium flow to a well if the time-drawdown curve plotted to a semi-log scale becomes a straight line (fig. C-6). The formation constants (T' and S) can be computed from

$$T' = \frac{2640'w}{As} \quad (C-7)$$

and

$$S = \frac{0.3T't_0}{r^2} \quad (C-8)$$

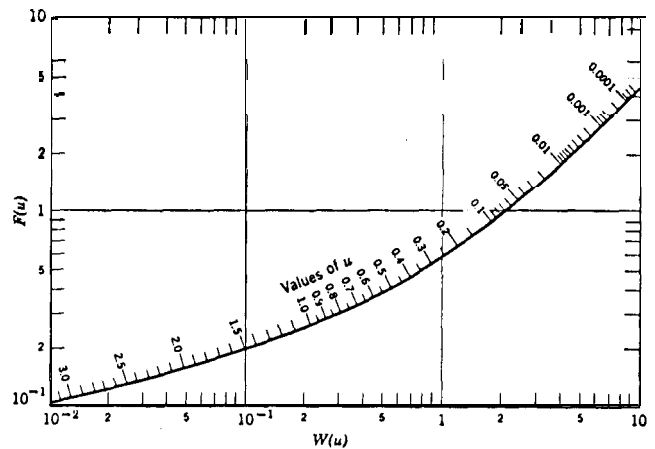

(From "Ground Water Hydrology" by D. K. Todd, 1959, Wiley & Sons, Inc. Used with permission of Wiley & Sons, Inc.)

Figure C-10. Relation among $F(u)$, $W(u)$, and u .

where

S_s = drawdown in feet per cycle of (log) time-drawdown curve

t_0 = time at zero drawdown in days

An example of the use of this method of analysis in determining values of T , S , and k is given in figure C-6, using the nonequilibrium portion of the time-drawdown curve.

(4) *Gravity flow.* Although the equations for nonequilibrium pumping tests are derived for artesian flow, they may be applied to gravity flow if the drawdown is small with respect to the saturated thickness of the aquifer and is equal to the specific yield of the dewatered portion of the aquifer plus the yield caused by compression of the saturated portion of the aquifer as a result of lowering the groundwater. The procedure for computing T' and S for *nonequilibrium gravity flow* conditions is outlined below.

Step 1. Compute T' from equation (C-3).

Step 2. Compute S from equation (C-4) for various elapsed pumping times during the test period, and plot S versus (log) t' .

Step 3. Extrapolate the S versus (log) t' curve to an ultimate value for S' .

Step 4. Compute u from equation (C-4), using the extrapolated S' , the originally computed T' , and the original value of r^2/t' .

Step 5. Recompute T' from equation (C-3) using a $W(u)$ corresponding to the computed value of u .

(5) *Recharge.* Time-drawdown curves of a test well are significantly affected by recharge or depletion of the aquifer, as shown in figure C-11. Where recharge does not occur, and all water is pumped from storage, the H' versus (log) t curve would resemble curve a. Where the zone of influence intercepts a source of seepage, the H' versus (log) t curve would resemble curve b. There may be geological and recharge conditions where there is some recharge but not

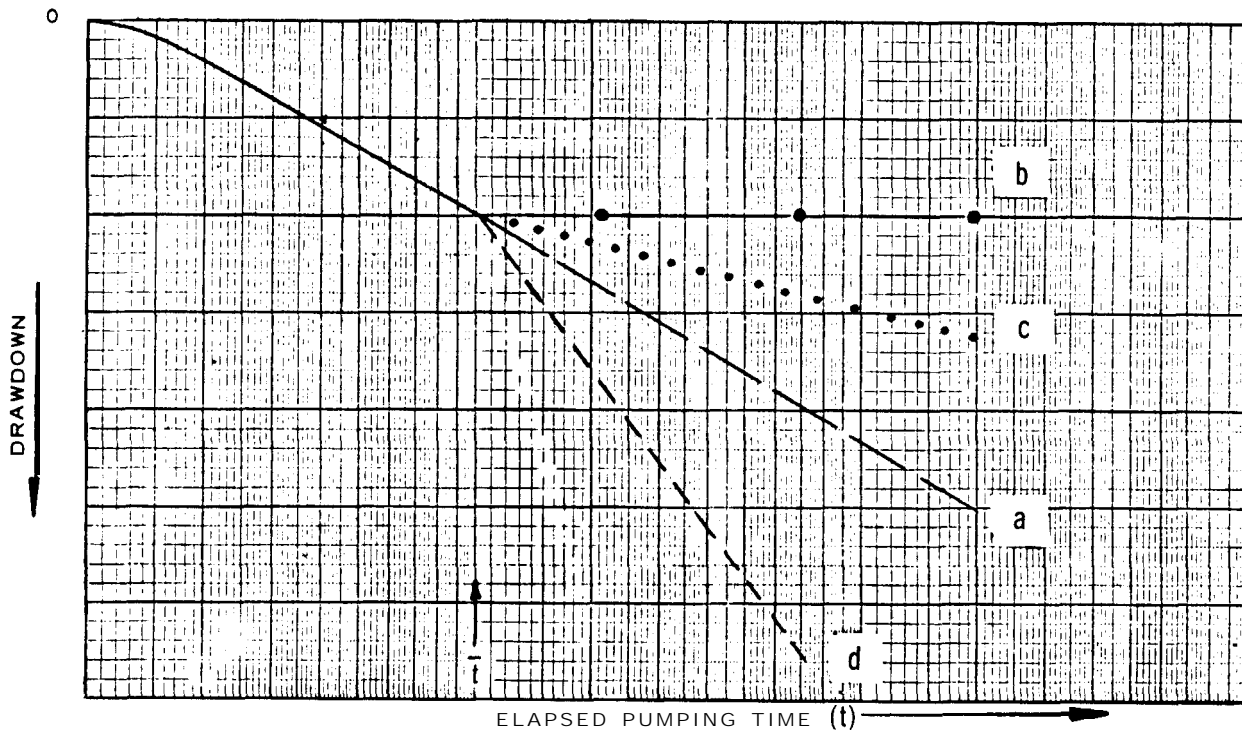

CURVE a - ALL WATER FROM STORAGE-NO AQUIFER RECHARGE.

- b - CONE OF INFLUENCE INTERCEPTS A SOURCE OF SEEPAGE AT TIME \bar{t} .
- c - CONE OF INFLUENCE INTERCEPTS A SOURCE OF SEEPAGE AT TIME \bar{t} WITH SUPPLY LESS THAN RATE OF PUMPING AT TIME \bar{t} .
- d - CONE OF INFLUENCE INTERCEPTS AN IMPERMEABLE BOUNDARY AT TIME \bar{t} .

U.S. Army Corps of Engineers

Figure C-11. Time-drawdown curves for various conditions of recharge

enough to equal the rate of well flow (e.g., curve c). In many areas, formation boundary conditions exist that limit the areal extent of aquifers. The effect of such a boundary on an H' versus $(\log) t$ graph is in reverse to the effect of recharge. Thus, when an impermeable boundary is encountered, the slope of the H' versus $(\log) t$ curve steepens as illustrated by curve d. It should be noted that a *nonequilibrium* analysis of a pumping test is valid only for the first segment of a time-drawdown curve.

b. Step-drawdown pump test.

(1) The efficiency of a well with respect to entrance losses and friction losses can be determined from a *step-drawdown* pumping test, in which the well is pumped at a constant rate of flow until either the **drawdown** becomes stabilized or a straight-line relation of the time-drawdown curve plotted to a **semilog** scale is established. Then, the rate of pumping is in-

creased and the above-described procedure repeated until the well has been pumped at three or four rates. The **drawdown** from each step should be plotted as a continuous time-drawdown curve as illustrated in figure C-12. The straight-line portion of the **time-drawdown** curves is extended as shown by the dashed lines in figure C-12, and the incremental **drawdown** $\Delta H'$ for each step is determined as the difference between the plotted and extended curves at an equal time after each step in pumping. The **drawdown** H' for each step is the sum of the preceding incremental drawdowns and can be plotted **versus** the pumping rate as shown in figure C-13. If the flow is entirely laminar, the **drawdown** ($H-h$ for *artesian flow* and H^2-h^2 for *gravity flow*) versus pumping rate will plot as a straight line; if any of the flow is turbulent, the plot will be curved.

(2) The well-entrance loss H_e , consisting of friction losses at the aquifer and filter interface through the filter and through the well screen, can be deter-

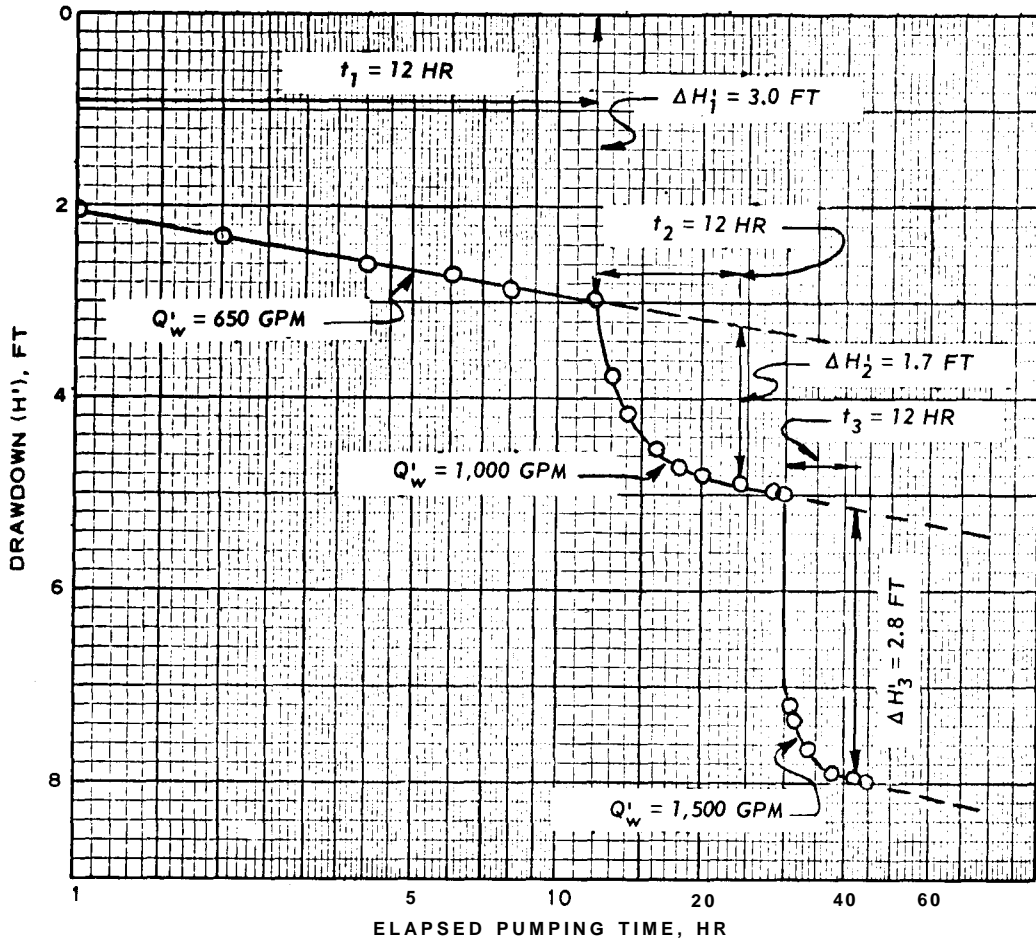

U.S. Army Corps of Engineers

Figure C-12. Drawdown versus elapsed pumping time for a step-drawdown test.

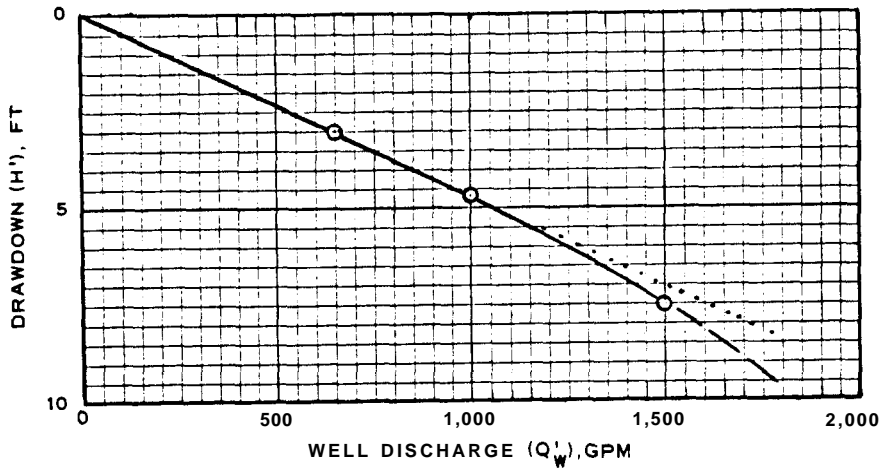

U. S. Army Corps of Engineers

Figure C-13. Drawdown versus pumping rate for a step-drawdown test.

mined from the drawdown versus distance plots for a step-drawdown pump test as illustrated in figure C-14. The difference in drawdown between the extended drawdown-distance curve and the water elevation measured in the well represents the well-entrance loss and can be plotted versus the pumping rate as shown in figure C-15. Curvature of the H_w versus Q_w line indicates that some of the entrance head loss is the result of turbulent flow into or in the well.

c. Recovery test.

(1) A recovery test may be made at the conclusion of a pumping test to provide a check of the pumping test results and to verify recharge and aquifer boundary conditions assumed in the analysis of the pumping test data. A recovery test is valid only if the pumping test has been conducted at a constant rate of discharge. A recovery test made after a step-drawdown test cannot be analyzed.

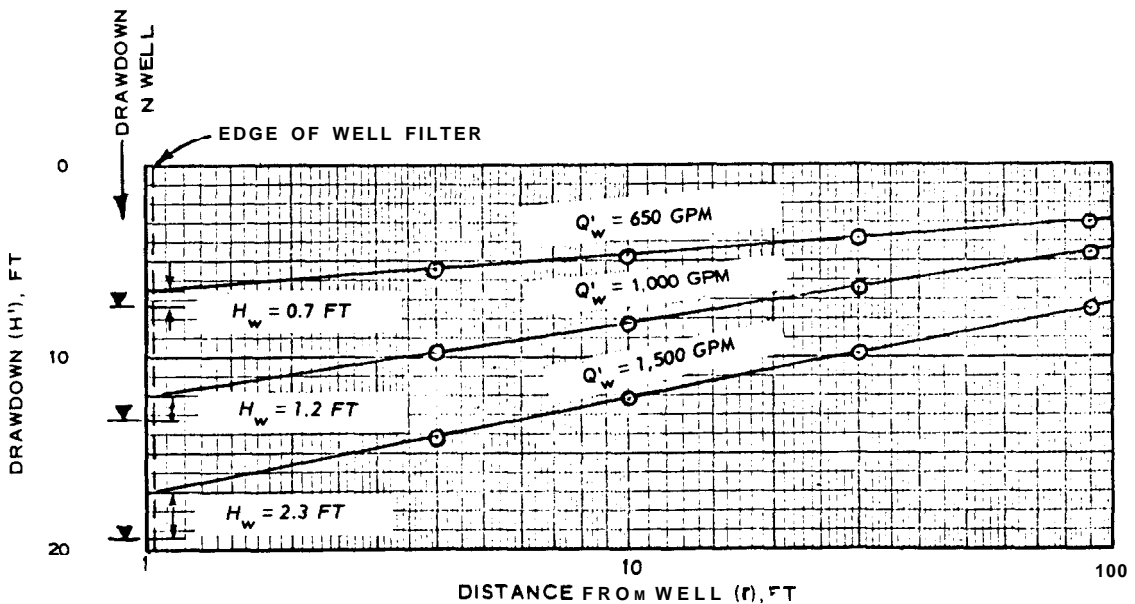

U. S. Army Corps of Engineers

Figure C-14. Drawdown versus distance for a step-drawdown test for determining well-entrance loss.

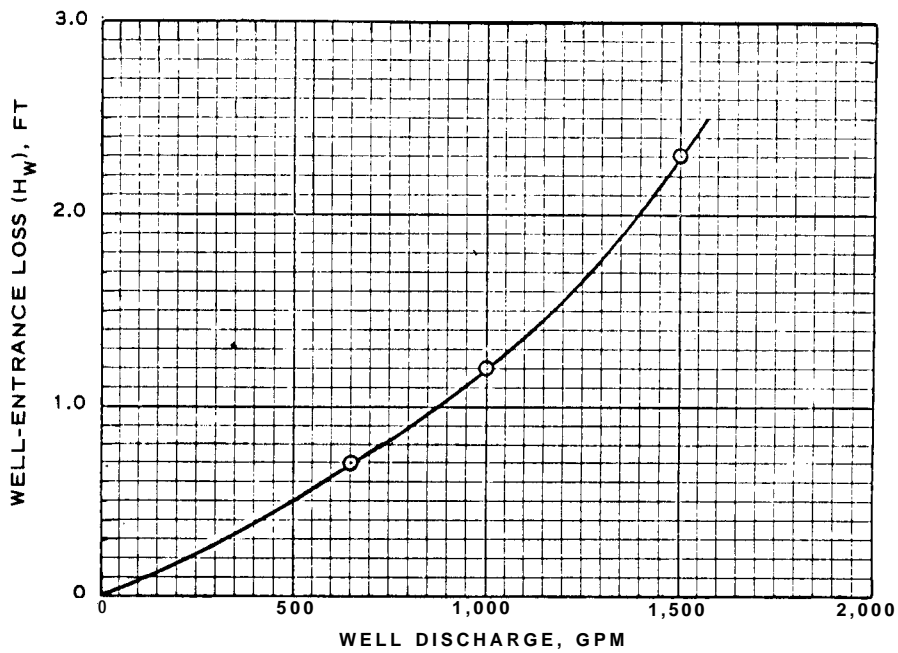

U. S. Army Corps of Engineers

Figure C-15. Well-entrance loss versus pumping rate for a step-drawdown test.

(2) When the pump is turned off, the recovery of the groundwater levels is observed in the same manner as when the pump was turned on, as shown in figure C-16. The residual drawdown H' is plotted versus the

ratio of $\log t'/t''$, where t' is the total elapsed time since the start of pumping, and t'' is the elapsed time since the pump was stopped (fig. C-17). This plot should be a straight line and should intersect the zero

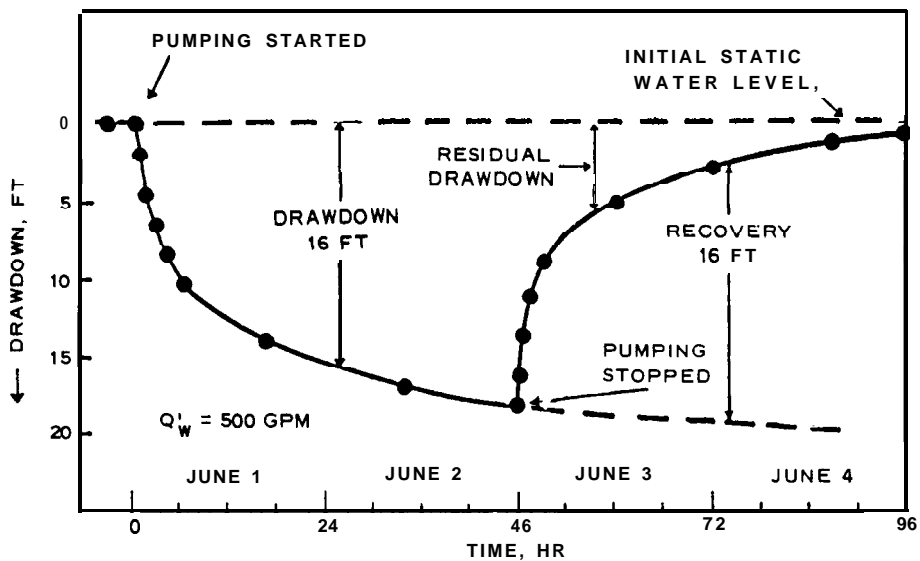

(Courtesy of UOP Johnson Division)

Figure C-16. Typical drawdown and recovery curves for a well pumped and then allowed to rebound.

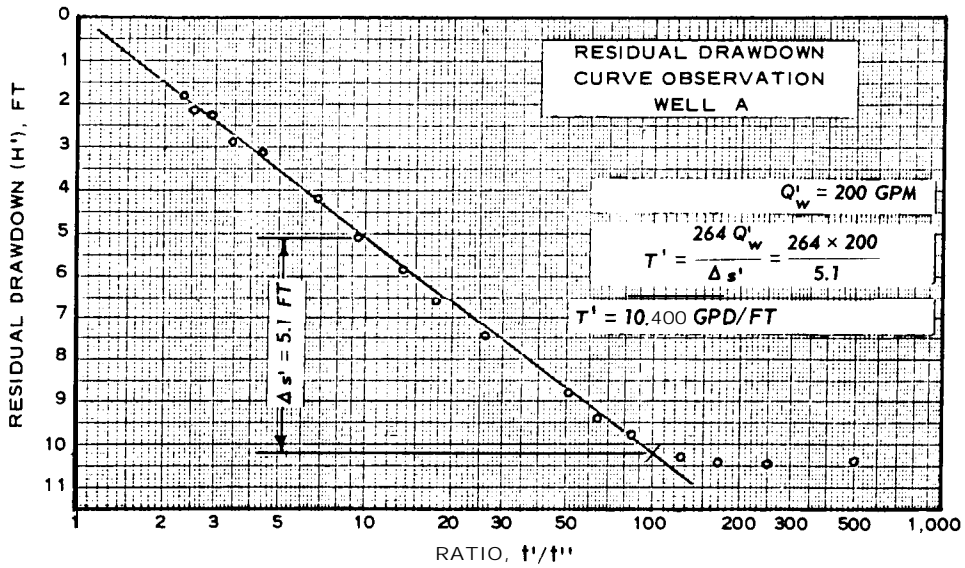

(Courtesy of UOP Johnson Division)

Figure C-17. Residual drawdown versus t'/t'' (time during recovery period increased toward the left).

residual drawdown at a ratio of $t'/t'' = 1$ if there is normal recovery, as well as no recharge and no discontinuities in the aquifer within the zone of drawdown. The ratio t'/t'' approaches one as the length of the recovery period is extended.

(3) The transmissibility of the aquifer can be calculated from the equation

$$T = \frac{264Q'_w}{As'} \tag{C-9}$$

where As' = residual drawdown in feet per cycle of (log) t'/t'' versus residual drawdown curve. Displacement of the residual drawdown versus (log) ratio t'/t'' curve, as shown in figure C-18, indicates a variance with the assumed conditions.

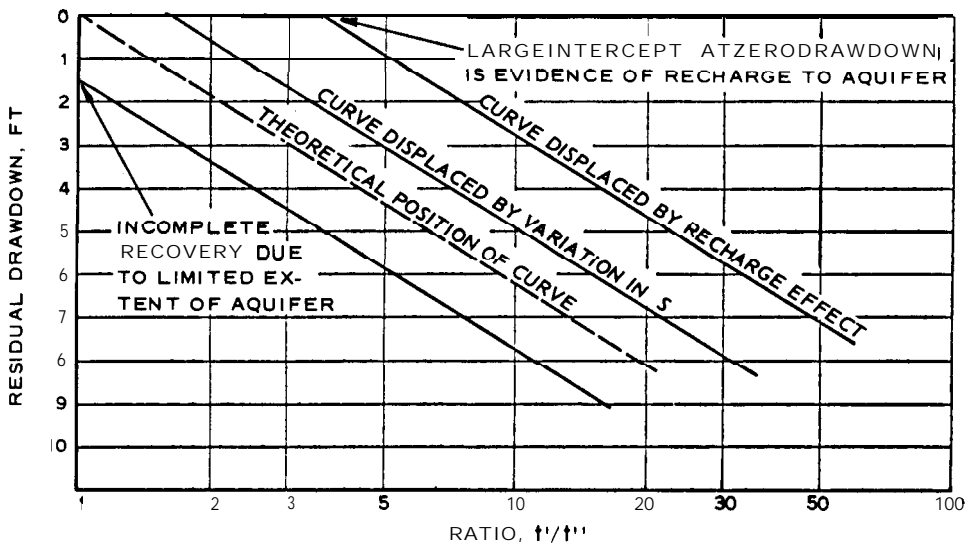

(Courtesy of UOP Johnson Division)

Figure C-18. Displacement of residual drawdown curve when aquifer conditions vary from theoretical conditions

APPENDIX D

EXAMPLES OF DESIGN OF **DEWATERING** AND
PRESSURE RELIEF SYSTEMS

This appendix consists of figures D-1 through D- 10, which follow.

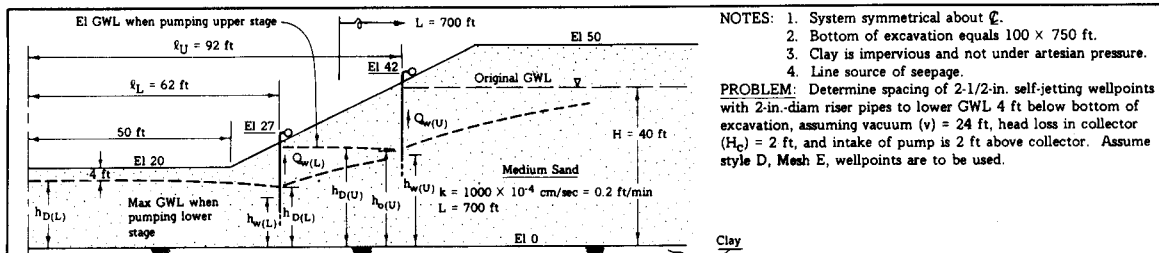

NOTES: 1. System symmetrical about CL.
 2. Bottom of excavation equals 100 x 750 ft.
 3. Clay is impervious and not under artesian pressure.
 4. Line source of seepage.

PROBLEM: Determine spacing of 2-1/2-in. self-jetting wellpoints with 2-in.-diam riser pipes to lower GWL 4 ft below bottom of excavation, assuming vacuum (v) = 24 ft, head loss in collector (Hc) = 2 ft, and intake of pump is 2 ft above collector. Assume style D, Mesh E, wellpoints are to be used.

SOLUTION: Compute spacing of wellpoints so that available (net) vacuum in headers (20 ft) will lower water level at wellpoints below that required to produce the necessary h_D . Assume two stages of wellpoints will be required and that each stage will be installed 2 ft above the groundwater table existing at the time of installation. Also, assume $r_w = 0.12$ ft.

Upper stage. Install upper stage at el 42, and 92 ft from CL of the excavation, to temporarily lower the groundwater 15 ft to el 25 to permit installation of a lower stage of wellpoints at el 27. Required $h_D = 25$ ft. Compute h_o at a partially penetrating slot from eq 4 (fig. 4-3)

$$h_{D(U)} = h_o(U) \left[\frac{1.48}{L} (H - h_o) + 1 \right] \quad \therefore 25 = h_o(U) \left[\frac{1.48}{700} (40 - h_o) + 1 \right] \quad \therefore h_o(U) = 24.2 \text{ ft}$$

Compute Q_p to a partially penetrating slot from eq 3 (fig. 4-3).

$$Q_p = \left[0.73 + 0.27 \left(\frac{H - h_o}{H} \right) \right] \frac{k}{2L} (H^2 - h_o^2) = \left[0.73 + 0.27 \left(\frac{40 - 24.2}{40} \right) \right] \frac{0.2}{2(700)} (40^2 - 24.2^2)$$

$$Q_p = 0.121 \text{ cfm/ft} = 0.91 \text{ gpm/ft}$$

Assume $a = 10$ ft, then $Q_w = aQ_p = 9.1$ gpm.

From a plan flow net it can be shown that the average flow for a finite line of wellpoints for this excavation will be about 35 percent greater than for an infinite line. Thus $Q_w = 1.35 (9.1 \text{ gpm}) = 1.64 \text{ cfm}$.

Calculate head at wellpoint, h_w , from eq 1 (fig. 4-22).

$$h_D^2 - h_w^2 = \frac{Q_w}{\pi k} \ln \frac{a}{2\pi r_w} \quad \therefore h_w^2 = (25)^2 - \frac{1.64}{0.2\pi} \ln \frac{10}{2\pi(0.12)} \quad \therefore h_w = 24.9 \text{ ft}$$

For $Q_w = 12.3$ gpm and well screen length = 3 ft, the hydraulic head losses are as follows:

$$H_e = 0.2 \text{ ft from fig. 4-6a, curve 7} \quad H_s = 0.9 \text{ ft from fig. 4-6b} \quad H_r + H_v = 0.5 \text{ ft from fig. 4-26c which includes loss in swing.}$$

$$H_{w(U)} = 1.6 \text{ ft. Thus } h_w(U) - H_{w(U)} = 24.9 - 1.6 = 23.3 \text{ ft.}$$

Therefore, the required effective vacuum in the header = el 42 - 23.3 = 18.7 ft. Since this value is slightly less than the available 20 ft, a wellpoint spacing of 10 ft with header at el 42 and top of wellpoint at el 21 would be satisfactory.

Lower stage. Install lower stage at el 27 and 62 ft from CL of the excavation, to lower the groundwater to el 16. Required $h_{D(L)} = 16$ ft. Compute $h_o(L)$ at a partially penetrating slot from eq 4 (fig. 4-3).

$$h_{D(L)} = h_o(L) \left[\frac{1.48}{L} (H - h_o) + 1 \right] \quad \therefore 16 = h_o(L) \left[\frac{1.48}{700} (40 - h_o) + 1 \right] \quad \therefore h_o(L) = 15.2 \text{ ft}$$

Compute Q_p to a partially penetrating slot from eq 3 (fig. 4-3).

$$Q_p = \left[0.73 + 0.27 \left(\frac{H - h_o(L)}{H} \right) \right] \frac{k}{2L} (H^2 - h_o^2) = \left[0.73 + 0.27 \left(\frac{40 - 15.2}{40} \right) \right] \frac{0.2}{2(700)} (40^2 - 15.2^2) = 0.175 \text{ cfm/ft} = 1.3 \text{ gpm/ft}$$

Assume $a = 15$ ft, then $Q_w = aQ_p = 15 \times 1.3 = 19.5$ gpm for an infinite line of wellpoints. For finite line of wellpoints, increase Q_w in this case by 35 percent. $Q_w = 1.35 \times 26.3 \text{ gpm} = 3.52 \text{ cfm}$.

Calculate head at wellpoint, $h_w(L)$, from eq 1 (fig. 4-22).

$$h_{D(L)}^2 - h_w(L)^2 = \frac{Q_w}{\pi k} \ln \frac{a}{2\pi r_w} \quad \therefore h_w(L)^2 = (16)^2 - \frac{3.52}{0.2\pi} \ln \frac{15}{2\pi(0.12)} \quad \therefore h_w(L) = 15.5 \text{ ft}$$

For $Q_w = 26.3$ gpm and a well screen length of 3 ft, the hydraulic head losses are as follows:

$$H_e = 0.3 \text{ ft from fig. 4-25a} \quad H_s = 2.0 \text{ ft from fig. 4-25b} \quad H_r + H_v = 1.5 \text{ ft from fig. 4-25c}$$

$$H_{w(L)} = 3.8 \text{ ft. Thus } h_w - H_{w(L)} = 15.5 - 3.8 = 11.7 \text{ ft.}$$

Therefore, the required effective vacuum in the header = el 27 - 11.7 = 15.3 ft. Since the vacuum available in the header is 20 ft, the assumed spacing would be satisfactory.

The wellpoints would be installed with 21-ft-long riser pipes.

It would be advisable to observe groundwater levels before and during pumping of the upper stage and to measure the discharge. From these data, the design of the lower stage could be adjusted if observed values were appreciably different from the design values. Such differences can occur because of limitations in the accuracy of k , L , and H_w used in design.

(Modified from "Foundation Engineering," G. A. Leonards, ed., 1962, McGraw-Hill Book Company. Used with permission of McGraw-Hill Book Company.)

Figure D-1. Open excavation; two-stage wellpoint system; gravity flow.

PROBLEM: Design a system of 16-in. slotted screen wells, pumped by deep-well turbine pumps, for lowering the groundwater level 5 ft below the bottom of the excavation. Assume maximum allowable $Q_w = 1,200$ gpm, wells located 5 ft from top of slope, well radius $r_w = 1$ ft, and D_{10} of gravel filter = 0.25 mm.

SOLUTION: Estimate total flow required from eq 3 (fig. 4-17) using radius A_e of an equivalent large-diameter well computed from eq 6 (fig. 4-14).

$$A_e = \frac{4}{\pi} \sqrt{770/2 \times 370/2} = 340 \text{ ft}$$

$$Q_T = \frac{\pi(0.2)(85^2 - 45^2)}{\ln((2 \times 1,000)/340)} = 1,840 \text{ cfm} = 13,800 \text{ gpm}$$

Use 12 wells with $Q_w = 1,150$ gpm. Locate wells as shown in plan so as to intercept equal quantity of flow as indicated by flow net and to obtain approximate level drawdown beneath excavation. Compute head h_c at center of excavation and head h_w at a well from eq 3 and 4 (fig. 4-18) to check adequacy of system.

Head at Point C and Well 4 Computed by Method of Images for $Q_w = 1,150$ gpm = 153 cfm

Well	Head at Point C			Head at Well 4		
	S_1 ft	r_1 ft	$\ln \frac{S_1}{r_1}$	$S_{1,4}$ ft	$r_{1,4}$ ft	$\ln \frac{S_{1,4}}{r_{1,4}}$
1	1,620	390	1.42	1,650	410	1.39
2	1,630	420	1.36	1,640	400	1.41
3	1,800	290	1.82	1,800	240	2.02
4	2,040	180	2.42	2,050	1	7.65
5	2,280	330	1.93	2,300	250	2.22
6	2,400	390	1.82	2,420	370	1.88
7	2,400	390	1.82	2,435	460	1.67
8	2,280	330	1.93	2,330	440	1.67
9	2,040	180	2.42	2,090	370	1.73
10	1,800	290	1.82	1,840	435	1.44
11	1,630	420	1.36	1,675	540	1.13
12	1,620	390	1.42	1,650	480	1.24

$$F_c = 21.54 \times 154 = 3320 \quad F_w = 25.44 \times 154 = 3920$$

From eq 2 and 3 (fig. 4-18), $H^2 - h_c^2 = \frac{3320}{\pi(0.2)} = 5280$. From eq 3 and 4 (fig. 4-18), $H^2 - h_w^2 = \frac{3920}{\pi(0.2)} = 6240$

$$h_c = \sqrt{85^2 - 5280} = 44.1 \text{ ft} \quad h_w = \sqrt{85^2 - 6240} = 31.4 \text{ ft}$$

The corresponding flow per foot of well screen is $1,150/32$, or 36 gpm per ft. Compute head loss in well H_w from fig. 4-24.

$$H_s = 1.80 \text{ ft} \quad (\text{from fig. 4-24a}) \quad H_v = 0.06 \text{ ft} \quad (\text{from fig. 4-24c})$$

$$H_t + H_s = 0.15 \left(\frac{32}{100} \times \frac{1}{2} \right) = 0.02 \quad (\text{from fig. 4-24b and using the flow through one-half the length of screen})$$

$$H_w = 1.88 \text{ ft, say } 2.0 \text{ ft}$$

Thus $h_w - H_w = 32.0 - 2.0 = 30.0$ ft. Bowls of pump should be set about 2 ft below this level, and the pump provided with a 10-ft suction pipe. With such a suction pipe, $H_t + H_s$ will be slightly less than the value computed above. Had the approximate method in fig. 4-19: (array 4) been used, the following values of F_c and F_w would have been obtained:

$$F_c = 154 \times 12 \ln \frac{2 \times 1,000}{340} = 3270$$

$$F_w = 154 \times \left[12 \ln \left(\frac{2 \times 1,025}{340} \right) + \ln \frac{340}{12 \times 1} \right] = 3840$$

These values agree closely with those computed by the exact method.

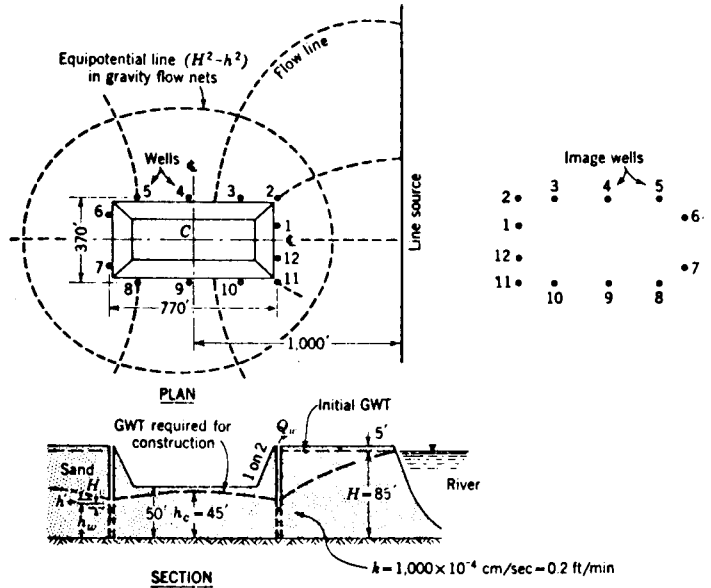

(Modified from "Foundation Engineering," G. A. Leonards, ed., 1962, McGraw-Hill Book Company. Used with permission of McGraw-Hill Book Company.)

Figure D-2. Open excavation; deep wells; gravity flow.

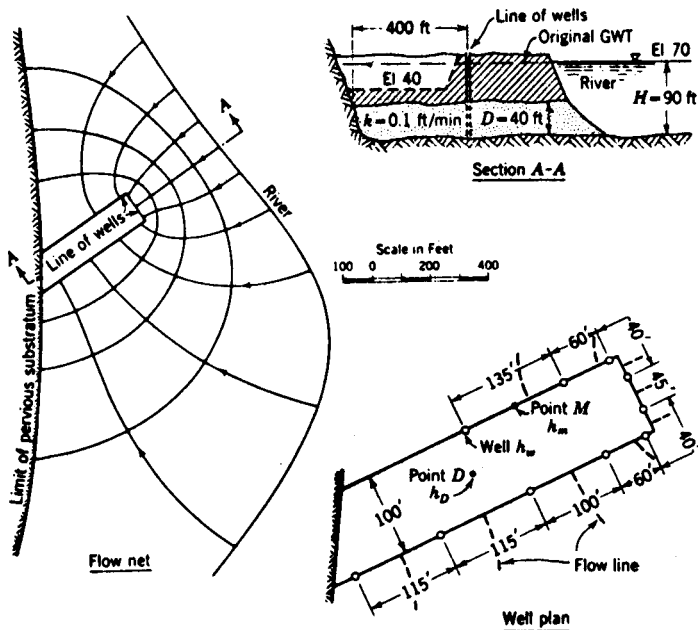

PROBLEM: Given the flow net, the data in the figure, and the plan of wells as shown, compute the well flow required to reduce the head in the sand stratum to el 40 ft at point D, the corresponding head h_w at the wells, h_m midway between wells, and h_D at the center of the excavation. Assume that wells fully penetrate the pervious stratum and that $D = 40$ ft, $k = 500 \times 10^{-4}$ cm/sec = 0.1 fpm, and $r_w = 1.0$ ft.

SOLUTION: Flow to slot (or wells) from flow net, eq 5 (fig. 4-27)

$$Q_T = k(H - h_e) \frac{N_f}{N_e} D = 0.1(90 - 60) \frac{10.0}{4.0} \times 40 = 300 \text{ cfm} = 2,250 \text{ gpm}$$

Assume 10 wells located as shown in "Well Plan." Since a well has been spaced at the center of each flow channel, the flow per well is the same for all wells. Thus $Q_w = 225$ gpm or 30 cfm per well.

From eq 2 (fig. 4-28)

$$H - h_w = \frac{30}{0.1(40)} \left[10 \left(\frac{4}{10} \right) + \frac{1}{2\pi} \ln \frac{90}{2\pi(1)} \right] = 33.2 \text{ ft}$$

Since the average well spacing a is approximately 90 ft, compute Δh_m from eq 3 (fig. 4-2a) for $a = 90$ ft.

$$\Delta h_m = \frac{30}{2\pi(0.1)40} \ln \frac{90}{\pi(1)} = 4.0 \text{ ft}$$

Thus

$$H - h_m = H - h_w - \Delta h_m = 33.2 - 4.0 = 29.2 \text{ ft}$$

From eq 1 (fig. 4-2a) for $a = 90$ ft,

$$\Delta h_D = \Delta h_w = \frac{30}{2\pi(0.1)40} \ln \frac{90}{2\pi(1)} = 3.2 \text{ ft}$$

Thus

$$H - h_D = H - h_w - \Delta h_D = 33.2 - 3.2 = 30.0 \text{ ft}$$

The heads h_w , h_m , and h_D in terms of elevation are as follows:

$$h_w = 70 - 33.2 = 36.8 \text{ ft MSL}$$

$$h_m = 70 - 29.2 = 40.8 \text{ ft MSL}$$

$$h_D = 70 - 30.0 = 40.0 \text{ ft MSL}$$

Since GWT is to be lowered to el 40 at point D and since the computed head at this point is at el 40.0, $Q_w = 30$ cfm, or 225 gpm per well will produce the required head reduction. The values of Δh_D , Δh_m , and $(H - h_w)$ also can be computed from eq 1 and 3 (fig. 4-21) and 3 (fig. 4-28) respectively, as shown below. Note that the values so obtained are identical to those computed above.

From fig. 4-21 $\theta_a = 0.42$ and $\theta_m = 0.53$ for $a/r_w = 90$ and $W/D = 100$ percent.

From eq 3 (fig. 4-28)

$$H - h_w = \frac{30}{0.1(40)} \left[10 \left(\frac{4}{10} \right) + 0.42 \right] = 33.2 \text{ ft}$$

From eq 3 (fig. 4-21)

$$\Delta h_m = \frac{30(0.53)}{0.1(40)} = 4.0 \text{ ft}$$

From eq 1 (fig. 4-21)

$$\Delta h_D = \Delta h_w = \frac{30(0.42)}{0.1(40)} = 3.2 \text{ ft}$$

(Modified from "Foundation Engineering," G. A. Leonards, ed., 1962, McGraw-Hill Book Company. Used with permission of McGraw-Hill Book Company.)

Figure D-3. Open excavation; artesian flow; pressure relief design by flow net.

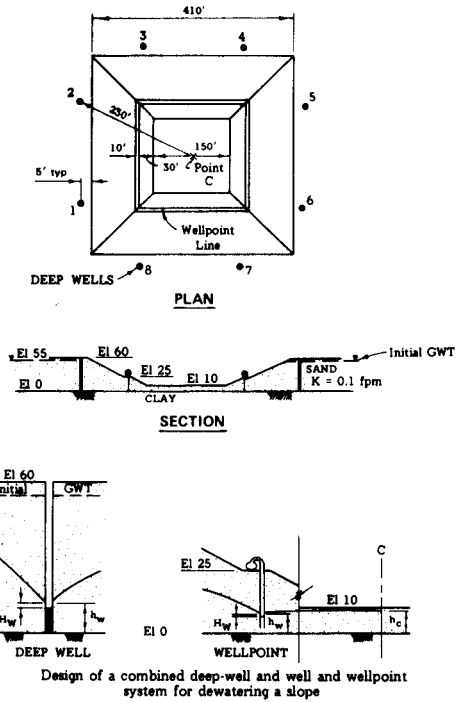

Wells should have about 15 ft of 12-in. well screen. From fig. 4-24, estimate $H_w = 0.9$ ft : $h_w - H_w = 11.1 - 0.9 = 10.2$ ft.

Wellpoints. Use 3-ft slotted wellpoints with filter, $r_w = 0.5$ ft, and 2-in. riser pipes 21 ft long; set header pipe at el 25. Assume wellpoint pump vacuum equals 24 ft with 2-ft friction loss in header and pump suction set 2 ft above header pipe. Net vacuum in header pipe equals 20 ft. Install wellpoints 110 ft from \mathcal{C} ; from eq 6 (fig. 4-14). $A_e = 140$ ft.

Assume some head, h , at the line of wells; the flow to the combined system can be expressed as follows (eq 3 (fig. 4-13) and 2 (fig. 4-14)).

$$H^2 - h^2 = \frac{nQ_w + Q_p(T)}{\pi k} \ln R/A_e \text{ (flow to line of wells)}$$

$$h^2 - h_c^2 = \frac{Q_p(T)}{\pi k} \ln \frac{R}{A_e} \text{ (flow from line of wells to wellpoints, } R = A_e \text{ for well, i.e., } R = 230 \text{ ft)}$$

Equate h^2 and solve for $Q_p(T)$

$$H^2 - h_c^2 = \frac{nQ_w + Q_p(T)}{\pi k} \ln \frac{R}{A_e} + \frac{Q_p(T)}{\pi k} \ln \frac{R}{A_e}$$

In order to prevent excessive drawdown at the wells, with both wells and wellpoints operating, reduce Q_w by 50 percent. Then $Q_w = 0.50(37.4) = 18.7$ cfm.

$$(55)^2 - (8)^2 = \frac{8(18.7) + Q_p(T)}{0.1\pi} \ln \frac{3170}{230} + \frac{Q_p(T)}{0.1\pi} \ln \frac{230}{140}$$

$$Q_p(T) = 172 \text{ cfm} = 1287 \text{ gpm}$$

The flow per foot of header is

$$Q_p = \frac{Q_p(T)}{\text{length}} = \frac{1287}{4(220)} = 1.46 \text{ gpm/ft}$$

Assume a wellpoint spacing (a) of 8 ft. Thus the flow per wellpoint, Q_w , is: $Q_w = 8(1.46) = 11.7$ gpm = 1.56 cfm

Compute head at wellpoint, h_w , from eq 1 (fig. 4-22) ($h_e = h_p$)

$$h_c^2 - h_w^2 = \frac{Q_w}{\pi k} \ln \frac{a}{2\pi r_w}$$

$$(8)^2 - h_w^2 = \frac{1.56}{0.1\pi} \ln \frac{8}{2\pi(0.5)}$$

$$h_w = 7.7 \text{ ft}$$

For $Q_w = 11.7$ gpm, the hydraulic head losses are as follows:

$$H_e = 0.1 \text{ ft, from fig. 4-25a, curve 5}$$

$$H_s = 1.0 \text{ ft, from fig. 4-25b}$$

$$H_v + H_f = 0.4 \text{ ft, from fig. 4-25c}$$

$$H_w = 1.4 \text{ ft}$$

Thus $h_w - H_w = 7.7 - 1.4 = 6.3$ ft

Therefore, the required effective vacuum at the header = el 25 - 6.3 = 18.7 ft.

Since this is less than the available 20 ft, a wellpoint spacing of 8 ft with the header at el 25 and the top of the wellpoint screen at el 4 would be satisfactory. Calculate drawdown at well from eq 3 (fig. 4-13) and 1 (fig. 4-14).

$$H^2 - h_w^2 = \frac{Q_w}{\pi k} [n \ln R - \ln nr_w - (n-1) \ln A_e] + \frac{Q_p(T)}{\pi k} \ln \frac{R}{A_e}$$

$$(55)^2 - h_w^2 = \frac{18.7}{\pi(0.1)} [8 \ln 3170 - \ln 8(1.0) - (8-1) \ln 230] + \frac{172}{\pi(0.1)} \ln \frac{3180}{230}$$

$$h_w = 11.7 \text{ ft}$$

From fig. 4-24, estimate H_w 0.7 ft: $h_w - H_w = 11.7 - 0.7 = 11.0$ ft.

In order to provide adequate pump submergence, set deep-well pump at el 3. (Since the actual drawdown in a well may be greater than the computed drawdown, it is generally advisable to set the pump intake not less than 7 to 10 ft below the computed drawdown in the well.)

PROBLEM: Design a combined deep-well and wellpoint system to lower the groundwater to 2 ft below the bottom of the excavation. Use deep wells located 5 ft back from the edge of the excavation to lower the groundwater to permit the installation of a single stage of wellpoints for lowering the groundwater below the bottom of the excavation.

SOLUTION:

Deep wells. The deep-well system must be designed such that the groundwater level is lowered 2 ft below the elevation at which the header pipes for the wellpoint system will be set. Set header pipes for wellpoint system at el 25. Required drawdown:

$$H - h_c = 55 - 23 = 32 \text{ ft}$$

Locate fully penetrating wells in a circular array around the perimeter of the excavation, $A_e = 230$ ft. Estimate radius of influence, R , from fig. 4-23 For $k = 0.1$ fpm and final drawdown, $H - h_D = 55 - (10 - 2) = 47$ ft, $R = 3180$ ft. Calculate flow to well system from eq 3 (fig. 4-13) and 2 (fig. 4-14).

$$H^2 - h_c^2 = \frac{nQ_w \ln R/A_e}{\pi k}$$

$$(55)^2 - (23)^2 = \frac{nQ_w \ln 3180/230}{\pi(0.1)}$$

$$nQ_w = 299 \text{ cfm} = 2233 \text{ gpm}$$

Try eight wells with radius, $r_w = 1.0$ ft (12-in. screen with 6-in. filter).

$$Q_w = \frac{299}{8} = \frac{299}{8} = 37.4 \text{ cfm} = 280 \text{ gpm}$$

Calculate drawdown at well from eq 3 (fig. 4-13) and 1 (fig. 4-14)

$$H^2 - h_w^2 = \frac{Q_w}{\pi k} \ln \left(\frac{R^n}{nr_w A_e^{(n-1)}} \right) = \frac{Q_w}{\pi k} [n \ln R - \ln nr_w - (n-1) \ln A_e]$$

$$(55)^2 - h_w^2 = \frac{37.4}{\pi(0.1)} [8 \ln 3180 - \ln 8(1.0) - (8-1) \ln 230]$$

$$h_w = 11.1 \text{ ft}$$

Figure D-4. Open excavation; combined deep-well and wellpoint system; gravity flow.

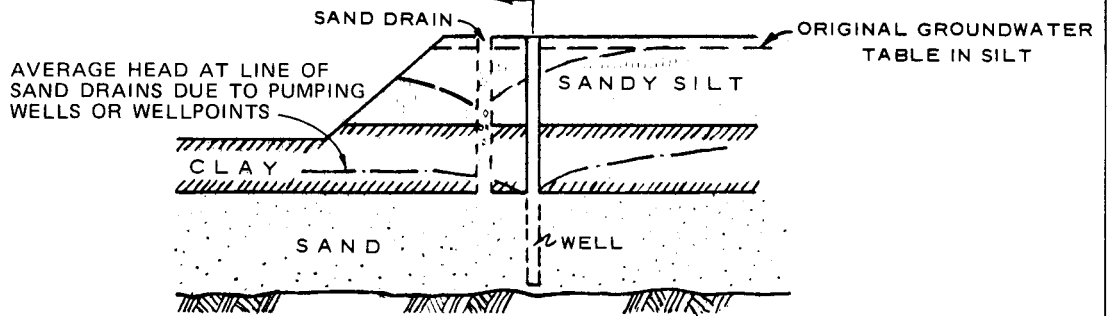

PROBLEM: Given a condition as shown, where $k = 5 \times 10^{-4}$ cm/sec, $H = 15$ ft, $z = 12$ ft, $z_1 = 3$ ft, $k_D = 1000 \times 10^{-4}$ cm/sec, $r_D = 0.5$ ft, $A_D = 0.785$ sq ft. Determine spacing of sand drains required to drain lift stratum.

SOLUTION: Compute Q_D from eq 4-12 assuming $h_w = 0$. Since Q_p must equal Q_D , substitute this value of Q_D in eq 1 (fig. 4-22) and compute h_o for various values of a assuming $h_w = 0$. Using these values of h_o and a , compute Q_p from eq 3 (fig. 4-3). The required spacing a is that which makes Q_p from eq 3 (fig. 4-3) equal to Q_D computed from eq 1 (fig. 4-22). From eq 4-12.

$$Q_D = \frac{0.20(12 - 3)0.785}{12} = 0.118 \text{ cfm} = 0.88 \text{ gpm}$$

Substituting this value of Q_D in eq 1 (fig. 4-22) and assuming $h_w = 0$ gives

$$h_o^2 = \frac{0.118}{\pi \times 0.001} \ln \frac{a}{2\pi(0.5)}$$

Also, from fig. 4-23, $L = 100$ ft for $H - h_w = 15$ ft. Substituting this value and the other constants into eq 3 (fig. 4-3) results in the following equation:

$$Q_p = \left[0.73 + \frac{0.27(15 - h_o)}{15} \right] \frac{0.001a}{2 \times 100} (15^2 - h_o^2)$$

Compute h_o and Q_p for various values of a from eq 1 (fig. 4-22) and eq 3 (fig. 4-3), respectively, which results in the values tabulated below.

a ft	h_o ft	Q_p	
		cfm	gpm
5	4.17	0.045	0.34
10	6.58	0.086	0.65
15	7.65	0.117	0.88
20	8.33	0.143	1.07

From the tabulation above, the required spacing is 15 ft, since the corresponding value of $Q_p = Q_D$ computed from eq 4-12. However, since the above equations do not consider effect of entrance head loss, the drain spacing should be reduced somewhat. Therefore, a spacing of about 10 to 12 ft would be used.

EQUATIONS:

$$Q_D = K_D i A_D = \frac{k_D (z - z_1 + h_w) A_D}{z + h_w}$$

$$Q_p = \left(0.73 + 0.27 \frac{H - h_o}{H} \right) \frac{k a}{2L} (H^2 - h_o^2)$$

$$h_o^2 = h_w^2 + \frac{Q_D}{\pi k} \ln \frac{a}{2\pi r_D} \text{ (where } h_D = h_d)$$

Note: To solve the equations above simultaneously, it is necessary to assume $h_w = 0$.

NOTATIONS:

Q_D = vertical flow per drain

Q_p = seepage through stratum being drained per length a measured along line of drains

k_D = vertical permeability of drain

A_D = sectional area of drain with radius r_D

k = permeability of stratum being drained

h_o = head at equivalent slot simulating line of drains

h_w = head at sand drain

a = spacing of drains

Other dimensions and symbols are as shown.

(Modified from "Foundation Engineering," G. A. Leonards, ed., 1962, McGraw-Hill Book Company. Used with permission of McGraw-Hill Book Company.)

Figure D-5. Open excavation; pressure relief combined with sand drains; artesian and gravity flows.

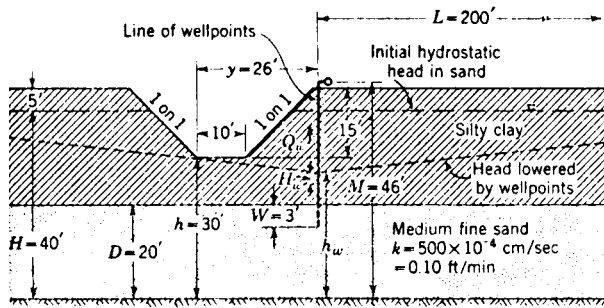

PROBLEM: Determine required spacing of 2-1/2-in.-ID 0.35-in. long, style CB self-jetting wellpoints with 2-in.-ID riser pipes to lower hydrostatic head to bottom of trench. Assume effective vacuum at top of riser pipe = 20 ft, $L = 200$ ft, and $r_w = 0.104$ ft.

SOLUTION: Use a single line of wellpoints at top of excavation, one stage being required. For $W/D = 3/20 = 0.15$, $\lambda = 0.82$ from fig. 4-4b; therefore $\lambda D = 0.82 \times 20 = 16.4$ ft. Maximum

h at trench = 30 ft. Assume this value of h at the far edge of the trench, a distance y of 26 ft from the line of wellpoints. Compute the required h_e from eq 2 (fig. 4-4) as follows:

$$30 = h_e + (40 - h_e) \frac{26 + 16.4}{200 + 16.4} \text{ or } h_e = 27.7 \text{ ft}$$

The flow Q_p per unit length of system as computed from eq 1 (fig. 4-4) is

$$Q_p = \frac{2 \times 0.1 \times 20 \times 1 \times (40 - 27.6)}{200 + 16.4} = 0.23 \text{ cfm} = 1.7 \text{ gpm per ft of trench}$$

Compute Δh_w from eq 1 (fig. 4-20), h_w from eq 2 (fig. 4-21), and H_w from fig. 4-25, and select a so that $h_w - H_w \geq 26$ ft (M minus the vacuum at the top of the riser pipe).

a ft	Q_w cfm	Δh_w ft	h_w ft	Head Loss in Wellpoint, ft			H_w	$h_w - H_w$ ft
				H_s^\dagger	H_e^\ddagger	$H_r + H_v^\S$		
10	2.3	0.50	27.2	1.75	0.22	0.87	2.84	24.4
8	1.8	0.36	27.3	1.16	0.17	0.54	1.87	25.4
6	1.4	0.25	27.5	0.74	0.13	0.34	1.21	26.3

† From fig. 4-25b.

‡ From fig. 4-25a, assuming H_e same as that given by curve 7.

§ From fig. 4-25c, assuming $C = 110$.

Thus a spacing of 6 ft would be required, since $h_w - H_w$ should not be less than 26 ft. The tops of the wellpoint screens would be set slightly below the top of the sand stratum.

(Modified from "Foundation Engineering," G. A. Leonards, ed., 1962, McGraw-Hill Book Company. Used with permission of McGraw-Hill Book Company.)

Figure D-6. Trench excavation; pressure relief by wellpoints; artesian flow.

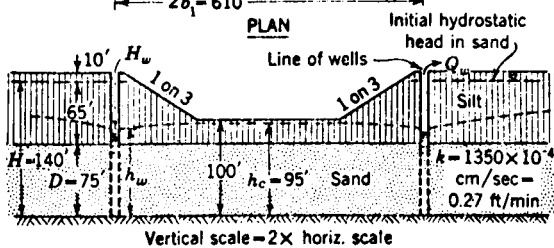
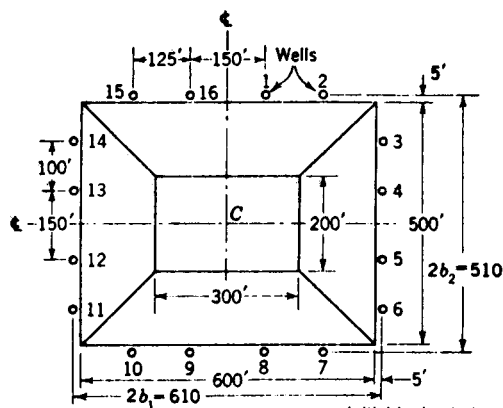

SECTION

PROBLEM: Determine the number of 10-in.-diam wells with 6-in. gravel filter required to lower the head in the sand stratum 5 ft below bottom of excavation, for wells located at the top of slope and pumped by deep-well turbine pump (assume $r_w = 1.0$ ft). Use a fully penetrating system of wood-stave wells with 3/16-in. slots and a gravel filter with D_{10} size = 0.25 mm. Area of slot \approx 10 percent of circumferential area of well screen. Geologic and soil conditions indicate a circular source of seepage $k = 1,350 \times 10^{-4}$ cm/sec or $2,700 \times 10^{-4}$ fpm.

SOLUTION: Determine equivalent radius A_e of well system from eq 6 (fig. 4-14) with wells located 5 ft from crown of slope

$$A_e = \frac{4}{\pi} \sqrt{b_1 b_2} = \frac{4}{\pi} \times \frac{610}{2} \times \frac{510}{2} = 355 \text{ ft}$$

From fig. 4-23, $R \approx 4,960$ ft for $k = 1,350 \times 10^{-4}$ cm/sec and $H - h_w = 45$ ft. Compute total required flow, Q_T , from eq IV-22 for $h_w = 95$ ft and $r_w = A_e = 355$ ft.

$$Q_T = \frac{2\pi k D (H - h_w)}{\ln(R/r_w)} = \frac{2\pi (0.27)(75)(140 - 95)}{\ln 4,960/355} = 2,100 \text{ cfm} = 16,000 \text{ gpm}$$

As 1,000 gpm is about the maximum that can be pumped in a normal 10-in.-deep well pump, 16 wells would be required. Try spacing shown on plan. Make computations for the 4 wells in one quadrant and multiply the results by 4.

For 4 wells: drawdown at center of excavation $H - h_c$ is determined from eq 1 and 2 (fig. 4-10) ($R_1 = R$): $Q_{wi} = \frac{15,000}{16} = 1000 \text{ gpm} = 134 \text{ cfm}$

Well	R_i , ft	r_i , ft	$\frac{\ln R}{r_i}$
1	4,700	266	2.93
2	4,700	324	2.73
3	4,700	352	2.65
4	4,700	314	2.76
			$\Sigma = 11.07$

$$H - h_c = \frac{\sum_{i=1}^4 Q_{wi} \ln \frac{R_i}{r_i}}{2\pi k D} = \frac{134(11.07)}{2\pi(0.27)(75)} = 11.6 \text{ ft}$$

For 16 wells:

$$H - h_c = 4(11.6) = 46.4 \text{ ft}$$

or

$$h_c = 140 - 46.4 = 93.6 \text{ ft}$$

Since the maximum allowable h_c is 95 ft, the system shown in plan is adequate. The approximate head h_w at a well is computed from eq 1 (fig. 4-20) using an average well spacing, a , of $2(510 + 610)/16 = 140$ ft.

$$\Delta h_w = \frac{Q_w}{2\pi k D} \ln \frac{a}{r_w} = \frac{134}{2\pi(0.27)(75)} \ln \frac{140}{1.0} = 3.3 \text{ ft; or } h_w \approx 93.6 - 3.3 = 90.3 \text{ ft}$$

Hydraulic head losses in wells are obtained from fig. 4-24, assuming intake of pump is about 85 ft above the bottom of the sand.

$$H_s = 0.60 \text{ ft (from fig. 4-24a, with } Q_w = 1,000 \text{ gpm/75 ft of screen} = 13.3 \text{ gpm/ft)}$$

$$H_z = 0.37 \text{ ft (from fig. 4-24b using a screen length of } 0.5(75) = 37.5 \text{ ft)}$$

$$H_r = 0.07 \text{ ft (from fig. 4-24b, for 10 ft of riser pipe and } C = 130)$$

$$H_v = 0.26 \text{ ft (from fig. 4-24c)}$$

$$H_w = 1.30 \text{ ft}$$

Thus the water surface in the wells would be about $90.3 - 1.3 = 89.0$ ft above the bottom of sand. Set pump bowl about 85 ft above bottom of sand and provide with 10-ft suction pipe.

(Modified from "Foundation Engineering," G. A. Leonards, ed., 1962, McGraw-Hill Book Company. Used with permission of McGraw-Hill Book Company.)

Figure D-7. Rectangular excavation; pressure relief by deep wells; artesian flow.

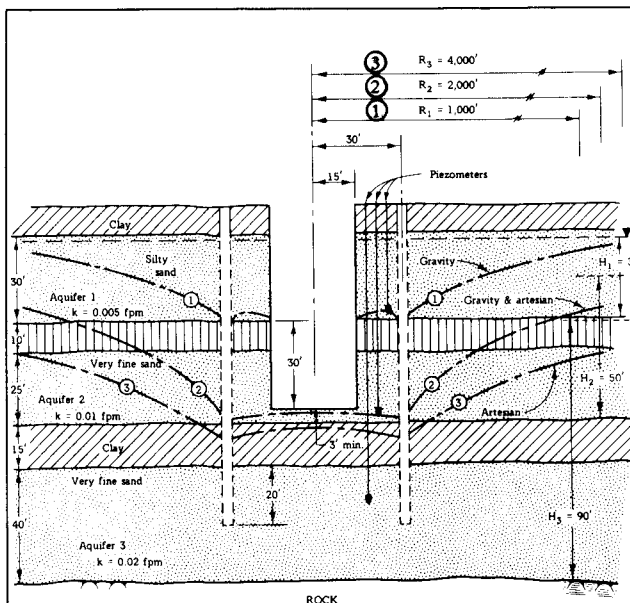

PROBLEM: Design a deep well and vacuum system to dewater a 70-ft deep shaft to be sunk into stratified clays and sand below the groundwater table. Assume a ring of wells installed 15 ft out from perimeter of shaft with an equivalent radius of influence, $A = 30$ ft. Wells to fully penetrate the sand strata penetrated by the shaft and pumps to have a capacity in excess of the flow to each well. Vacuum to be maintained in wells equals 15 ft. Assume radius of influence of vacuum (R) to be the same for seepage (i.e., vacuum varies from that at well or wells to zero at R). Maximum height of shaft exposed at any one time equals 30 ft.

SOLUTION:

Aquifer 1. Compute flow of water to wells assuming gravity flow for hydrostatic head, and "equivalent" artesian flow for the additional head produced by the vacuum in the wells. Assume $h_w = 2$ ft. Hydrostatic water flow, from eq 2 (fig. 4-11) ($r_w = A$):

$$Q_{T-H-1} = \frac{\pi k(H^2 - h_w^2)}{\ln R/A} = \frac{0.005\pi(30^2 - 2^2)}{\ln 1000/30} = 4.01 \text{ cfm}$$

Vacuum water flow, from eq 2 (fig. 4-10) ($r_w = A$, effective aquifer thickness,

$$D = \frac{H + h_w}{2}, \text{ and drawdown, } H - h_w = V):$$

$$Q_{T-V-1} = \frac{2\pi k \left(\frac{H + h_w}{2}\right) V}{\ln R/A} = \frac{2(0.005)\pi \left(\frac{30 + 2}{2}\right) (15)}{\ln 1000/30} = 2.15 \text{ cfm}$$

Total water flow, aquifer 1, $Q_{T-1} = Q_{T-H-1} + Q_{T-V-1} = 4.01 + 2.15 = 6.16 \text{ cfm} = 46.1 \text{ gpm}$.

Aquifer 2. Compute the flow of water assuming combined artesian-gravity flow conditions for "Hydrostatic" water flow. Compute the additional flow caused by vacuum in wells assuming an equivalent artesian flow condition under the net vacuum head existing in the gravity flow region. Assume $h_w = 2$ ft.

Hydrostatic water flow, from eq 1 (fig. 4-12):

$$Q_{T-H-2} = \frac{\pi k(2DH - D^2 - h_w^2)}{\ln R/A} = \frac{0.01\pi[(2)(25)(50) - (25)^2 - (2)^2]}{\ln 2000/30} = 14.0 \text{ cfm}$$

Vacuum water flow; compute \bar{R} from eq 3 (fig. 4-12)

$$\ln \bar{R} = \frac{(D^2 - h_w^2) \ln R + 2D(H - D) \ln A}{2DH - D^2 - h_w^2} = \frac{(25^2 - 2^2) \ln 2000 + 2(25)(50 - 25) \ln 30}{2(25)(50) - (25)^2 - (2)^2} = 4.80$$

then $\bar{R} = 121$ ft.

Estimate vacuum at artesian-gravity flow boundary by plotting the vacuum versus $\log r$

($V = 15$ ft at $A = 30$ ft; $V = 0$ at $R = 2,000$ ft), the vacuum is 10 ft at $R = 121$ ft. Thus the net vacuum in the gravity flow region = $15 \text{ ft} - 10 \text{ ft} = 5$ ft. Vacuum water flow, from eq 2 (fig. 4-10)

$$Q_{T-V-2} = \frac{2\pi k \left(\frac{D + h_w}{2}\right) V}{\ln R/A} = \frac{2(0.01)\pi \left(\frac{25 + 2}{2}\right) 5}{\ln 121/30} = 3.04 \text{ cfm}$$

Total water flow, aquifer 2, $Q_{T-2} = Q_{T-H-2} + Q_{T-V-2} = 14.0 + 3.04 = 17.04 \text{ cfm} = 127.5 \text{ gpm}$.

Aquifer 3. For artesian flow, the head producing flow for the combined hydrostatic vacuum system is $H + V - h_w$. Assuming the circular array of wells to be a continuous drainage slot, for which $W/D = 50$ percent and $R/A = 133$, it can be seen from fig. 4-7 that the head in the center of the circular drainage slot approaches the head in the slot as R/A increases. Therefore, the flow to the wells for this situation can be computed from eq 2 (fig. 4-10), in which $(H - h_w) = (H + V - h_w)$, $G = 1$, and $r_w = A$.

$$Q_T = \frac{2\pi kD(H + V - h_w)}{\ln R/A} = \frac{2(0.02)\pi(40)(90 + 15 - 2)}{\ln 4000/30} = 80.1 \text{ cfm} = 599 \text{ gpm}$$

Total flow to well system = $46.1 + 127.5 + 599.4 = 773 \text{ gpm}$.

Use 12 wells located 30 ft from the center of the shaft, with a spacing (a) between wells of 15.5 ft.

$$\text{Flow per well, } Q_w = \frac{773}{12} = 64.4 \text{ gpm} = 8.61 \text{ cfm}$$

Compute Δh_w for the artesian flow in aquifer 3 to determine the required draw-down in the well. From eq IV-80 (and fig. IV-21 for values of θ_s),

$$\Delta h_w = \frac{Q_w \mu_s}{kD} = \frac{64 \times 0.02 \times 5}{7.5 \times 0.02 \times 40} = 5.33 \text{ ft}$$

Thus $h_w = 57 - 5.3 = 51.7$.

Use 8-in. well screens with 6-in.-thick filter surrounding the screen. Check screen hydraulics:

	Aquifer 1	Aquifer 2	Aquifer 3
Total flow, Q_w	46.1 gpm	127.5 gpm	599.4 gpm
Well flow, Q_w	3.8 gpm	10.6 gpm	50.0 gpm
Wetted screen length	2.0 ft	2.0 ft	20.0 ft
Flow per ft of screen	1.9 gpm	5.3 gpm	2.5 gpm

From fig. 4-24a, it can be seen that the well entrance losses (H_e) should be negligible.

Vacuum system. It is assumed that the overlying clay is a continuous impermeable formation, and that the quantity of air that may enter the aquifers through the clay is negligible compared to that which will enter through the exposed excavation surface. It is also assumed that only one aquifer will be exposed at a time, and that the permeability of the aquifers for the flow of air is effectively reduced by half due to the capillary water retained in the voids of soil following the lowering of the water table.

Compute the airflow to the wells from eq 1 (fig. 4-3). To obtain the shape factor, construct a plan flow net for the flow of air from the shaft excavation to the wells, for which

$$\beta = \frac{N_f}{N_d} = 0.6 \text{ per well}$$

$$Q_a = \Delta p (D - h_w) \mu_a$$

Aquifer 1

$$Q_a = 15 \text{ ft}(30 \text{ ft} - 2 \text{ ft}) \frac{0.005}{2} \left(\frac{2.359 \times 10^{-5} \text{ lb sec/ft}^2}{3.744 \times 10^{-7} \text{ lb sec/ft}^2} \right) 0.6 = 39.7 \text{ cfm/well}$$

Total airflow = $12(39.7) = 476.6 \text{ cfm}$ at the mean absolute pressure,

$$p, \text{ of } \frac{34 + (34 - 15)}{2} = 26.5 \text{ ft of water.}$$

Compute the required vacuum pump capacity

$$Q_{a-vp} = Q_a \frac{p}{34} = 476 \left(\frac{26.5}{34} \right) = 371 \text{ cfm}$$

Aquifer 2

$$Q_a = 15(25 - 2) \frac{0.01}{2} \left(\frac{2.359 \times 10^{-5}}{3.744 \times 10^{-7}} \right) 0.6 = 65.2 \text{ cfm/well}$$

Total airflow = $12(65.2) = 783 \text{ cfm}$ at $p = 26.5$ ft of water

$$Q_{a-vp} = 783 \left(\frac{26.5}{34} \right) = 610 \text{ cfm}$$

Provide vacuum pumps with a total capacity of 610 cfm at 15 ft (of water) vacuum.

U. S. Army Corps of Engineers

Figure D-8. Shaft excavation; artesian and gravity flows through stratified foundation; deep-well vacuum system.

PROBLEM: Design a deep-well system to dewater an excavation for a tunnel for the conditions shown. For a single-line source, use the method of image analysis. The layout, as shown, was determined from an approximate flow net sketched for preliminary design purposes.

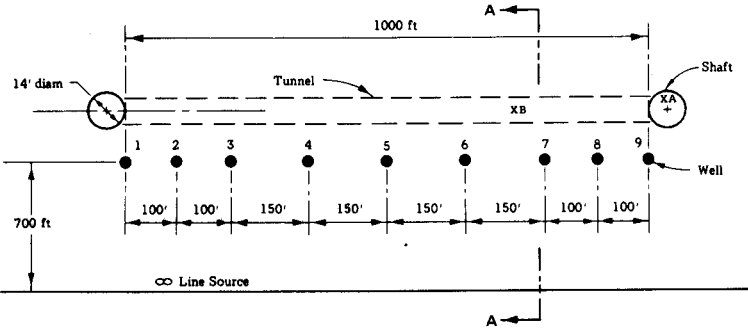

PLAN

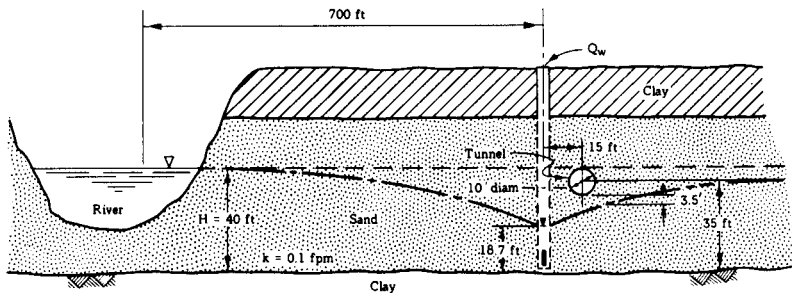

SECTION A-A

SOLUTION: Assume 12-in. fully penetrating wells with surrounding filter, $r_w = 1.0$ ft. For an assumed $Q_w = 150$ gpm, the drawdown at points A and B and at well 5 are computed from eq 2 and 3 (fig. 4-18):

$$H^2 - h_p^2 = \frac{1}{\pi k} \sum_{i=1}^{i=n} Q_{wi} \ln \frac{S_i}{r_i}$$

Well	At Point A			At Point B			At Well 5		
	r_i ft	S_i ft	$\ln S_i/r_i$	r_i ft	S_i ft	$\ln S_i/r_i$	r_i ft	S_i ft	$\ln S_i/r_i$
1	1010	1740	0.54	730	1590	0.78	500	1490	1.09
2	910	1680	0.61	630	1540	0.89	400	1455	1.29
3	810	1630	0.70	530	1510	1.05	300	1430	1.56
4	660	1560	0.86	380	1465	1.35	150	1410	2.24
5	510	1500	1.08	230	1430	1.83	1	1400	7.24
6	360	1460	1.40	80	1415	2.87	150	1410	2.24
7	210	1430	1.92	80	1415	2.87	300	1430	1.56
8	110	1420	2.56	175	1425	2.10	400	1455	1.29
9	17	1415	4.42	275	1440	1.66	500	1490	1.09
Total			14.09			15.40			19.60

$$h_p^2 = 1600 - \frac{150(14.09)}{0.1\pi(7.5)}$$

$$h_p = 26.5 \text{ ft}$$

$$h_p^2 = 1600 - \frac{150(15.40)}{0.1\pi(7.5)}$$

$$h_p = 24.9 \text{ ft}$$

$$h_p^2 = h_w^2 = 1600 - \frac{150(19.60)}{0.1\pi(7.5)}$$

$$h_w = 18.8 \text{ ft}$$

For $h_w = 18.8$ ft, the flow per foot of well screen would be $\frac{150 \text{ gpm}}{18.8} = 8.0$ gpm/ft, which is a satisfactory rate of inflow. The maximum allowable head at points A and B is $35 - 5 - 3.5 = 26.5$. Thus the system is adequate.

U. S. Army Corps of Engineers

Figure D-9. Tunnel dewatering; gravity flows; deep-well system.

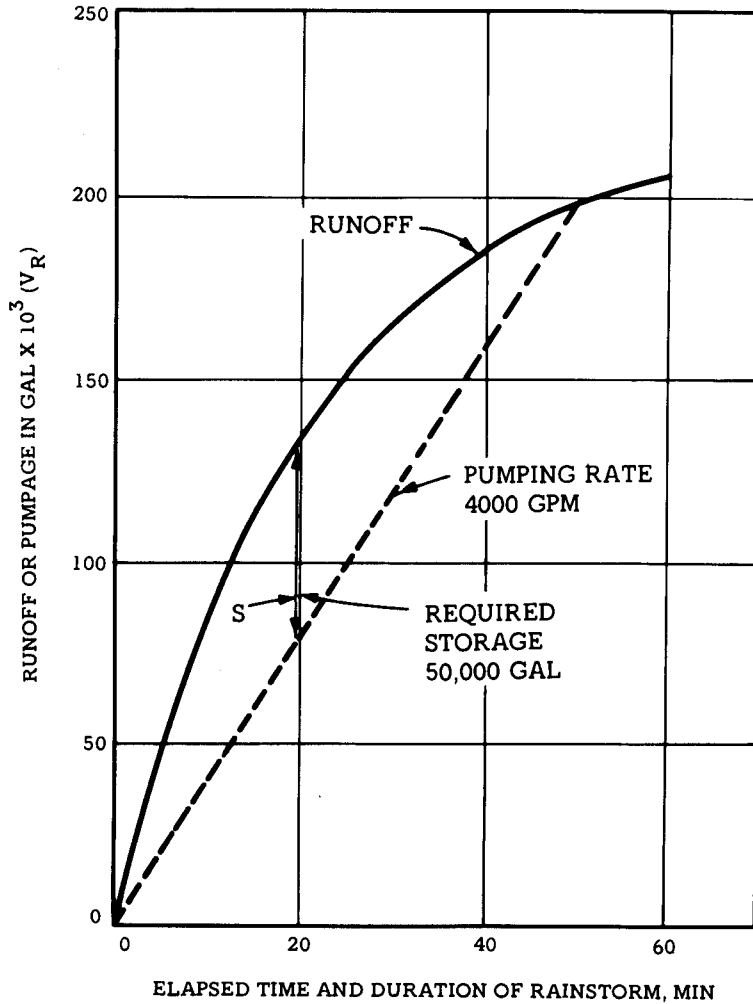

PROBLEM: Determine sump and pump capacity to control surface water in an excavation, 4 acres in area, located in Little Rock, Ark., for a rainstorm frequency of 1 in 5 years and assuming $c = 0.9$. Assume all runoff to one sump in bottom of excavation.

SOLUTION:

$$V_R = cRA$$

FROM FIGURE:

<u>Rainstorm, min</u>	<u>R, in.</u>	<u>$V_R - (X 10^3 \text{ gal})$</u>
10	0.85	83
30	1.70	166
60	2.10	205

Assume sump pump capacity = 4000 gpm. From plot, required storage = 50,000 gal.

U. S. Army Corps of Engineers

Figure D-10. Sump and pump capacity for surface runoff to an excavation.

APPENDIX E

TRANSFORMATION OF ANISOTROPIC SOIL CONDITIONS
TO ISOTROPIC SOIL CONDITIONS

E-1. General. All of the analytical methods for computing seepage through a permeable deposit are based on the assumption that the permeability of the deposit is isotropic. However, natural soil deposits are stratified to some degree, and the average permeability parallel to the planes of stratification is greater than the permeability perpendicular to these planes. Thus, the soil deposit actually possesses anisotropic permeability, with the permeability in the horizontal direction usually the greatest. To construct a flow net or make a mathematical analysis of the seepage through an anisotropic deposit, the dimensions of the deposit and the problem must be transformed so that the permeability is isotropic. Each permeable stratum of the deposit must be separately transformed into isotropic conditions. If the seepage flows through more than one stratum (isotropically transformed), the analysis can be made by a flow net constructed to account for permeability of the various strata.

E-2. Anisotropic stratum. A homogeneous, anisotropic stratum can be transformed into an isotropic stratum in accordance with the following equation:

$$\bar{y} = y \sqrt{\frac{k_h}{k_v}} \quad (E-1)$$

where

- \bar{y} = transformed vertical dimension
- y = actual vertical dimension
- k_h = permeability in the horizontal direction
- k_v = permeability in the vertical direction

The horizontal dimensions of the problem would remain unchanged in this transformation. The permeability of the transformed stratum, to be used in all equations for flow or drawdown, is as follows:

$$\bar{k} = \sqrt{k_v k_h} \quad (E-2)$$

where \bar{k} equals the transformed coefficient of permeability.

E-3. Effective well penetration. In a stratified aquifer, the effective well penetration usually differs from that computed from the ratio of the length of well screen to total thickness of aquifer. To deter-

mine the required length of well screen W to achieve an effective penetration \bar{W} in a stratified aquifer, the following procedure can be used. This method is used in analyses to determine penetration depths needed to obtain required discharge from partially penetrating wells or wellpoints. Each stratum of the previous foundation or aquifer with thickness d and horizontal and vertical permeability coefficients k_h and k_v , respectively, is first transformed using equation (E-1) into an isotropic layer of thickness \bar{d} , where

$$= \bar{d} \sqrt{\frac{k_h}{k_v}}$$

The transformed coefficient of permeability of each stratum from equation (E-2) is

$$\bar{k} = \sqrt{k_h k_v}$$

The thickness of the equivalent homogeneous isotropic aquifer is

$$\bar{D} = \sum_{m=1}^{m=n} \bar{d}_m \quad (E-3)$$

where n equals the number of strata in the aquifer.

The effective permeability of the transformed aquifer is

$$\bar{k}_e = \frac{\sum_{m=1}^{m=n} \bar{k}_m \bar{d}_m}{\bar{D}} \quad (E-4)$$

where n equals the number of strata in the aquifer. The effective well-screen penetration into the transformed aquifer is

$$\bar{W} = \frac{\sum_{l=1}^{l=m} w_l k_{hl} + \sum_{m=1}^{m=l-1} d_m k_{hm}}{\bar{k}_e} \quad (E-5)$$

where

- w_l = actual well penetration in strata l
- l = number of strata penetrated by well

The penetration of the well screen in the transformed aquifer (expressed as a decimal) is \bar{W}/\bar{D} , where \bar{W} and \bar{D} are obtained from equations (E-5) and (E-3), respectively.

APPENDIX F

WELL AND TOTAL DISCHARGE MEASUREMENTS

F-1. General. The simplest method for determining the flow from a pump is to measure the volume of the discharge during a known period of time by collecting the water in a container of known size. However, this method is practical only for pumps of small capacity; other techniques must be used to measure larger flows.

F-2. Pipe-flow measurements.

a. Venturi meter. The flow from a dewatering system can be accurately measured by means of a venturi meter installed in the discharge line. In order to obtain accurate measurements, the meter should be located about 10 pipe diameters from any elbow or fitting, and the pipe must be flowing full of water. The flow through a venturi meter can be computed from

$$Q = 3.12CA = \frac{\sqrt{2g(h_1 - h_2)}}{\sqrt{1 - R^4}} \quad (F-1)$$

where

$$3.12 = \text{conversion factor} = \frac{7.48 \text{ gal/ft}^3 \times 60 \text{ sec/min}}{144 \text{ in.}^2/\text{ft}^2}$$

Q = flow, gallons per minute

C = calibrated coefficient of discharge (usually about 0.98)

A = area of entrance section where upstream manometer connection is made, square inches

g = acceleration of gravity (32.2 feet per second squared)

$h_1 - h_2$ = difference in pressure between entrance section and throat, as indicated by manometer, feet

R = ratio of entrance to throat diameter = d/d_1

The pressures h_1 and h_2 may be taken as illustrated in figure F-1 for low pressures, or by a differential mercury manometer for high pressures. Gages may be used but will be less accurate.

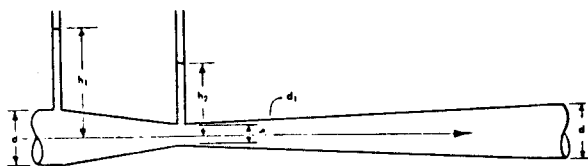

(Courtesy of Fairbanks Morse, Inc., Pump Division)

Figure F-1. Venturi meter.

b. Orifices.

(1) The flow from a pipe under pressure can be conveniently measured by installation of an orifice on the end of the pipe (fig. F-2), or by insertion of an orifice plate between two flanges in the pipe (fig. F-3). The pressure tap back of the orifice should be drilled at right angles to the inside of the pipe and should be perfectly smooth as illustrated in figure F-4. A rubber tube and glass or plastic pipe may be used to measure the pressure head. The diameter of the orifice plate should be accurate to 0.01 inch; the edge of the plate should be square and sharp, should have a thickness of $\frac{1}{8}$ inch, and should be chamfered at 45 degrees as shown in figure F-2. The approach pipe must be smooth, straight, and horizontal; it must flow full, and the orifice should be located at least eight pipe diameters from any valves or fittings. The flow for various sized cap orifice-pipe combinations can be obtained from figure F-5.

(2) The flow through an orifice in a pipe can be computed from

$$Q = CA_2 \frac{1}{\sqrt{1 - (d_2/d_1)^4}} \times \sqrt{2gh} \quad (F-2)$$

where

Q = capacity, cubic feet per second

C = orifice discharge coefficient

A_2 = area of orifice, square feet

d_2 = orifice diameter, inches

d_1 = pipe diameter, inches

g = 32.2 feet per second squared

h = pressure drop across the orifice in feet of head

(3) The expression $\sqrt{1 - (d_2/d_1)^4}$ corrects for the velocity of approach. The reciprocal of this expression and the coefficient C are listed in the following tabulation for various values of d_2/d_1 .

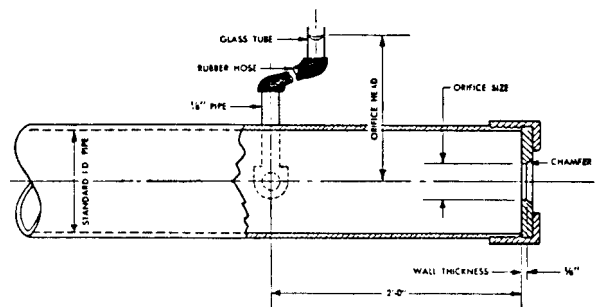

(Courtesy of Fairbanks Morse, Inc., Pump Division)

Figure F-2. Pipe cup orifice.

where

$$V = \frac{\sum_{n} v}{n}$$

and

v = velocity at center of concentric rings of equal area

n = number of concentric rings

F-3. Approximate measurement methods.

a. *Jet flow.* Flow from a pipe can be determined approximately by measuring a point on the arc of the stream of water emerging from the pipe (fig. F-6), using the following equation:

$$Q = \frac{3.61Ax}{\sqrt{y}} \tag{F-4}$$

where

Q = flow, gallons per minute

A = area of stream of water at end of pipe in square inches. If the pipe is not flowing full, the value of A is the cross-sectional area of the water jet where it emerges from the pipe. The area of the stream can be obtained by multiplying the area of the pipe times the Effective Area Factor (EAF) in figure F-7 using the ratio of the freeboard to the inside diameter of the pipe.

x = distance along axis of the discharge pipe through which the stream of water moves from the end of the pipe to a point(s), inches

y = distance perpendicular to the axis of the discharge pipe through which the stream of water drops, measured from the top or surface of the stream of water to point(s), inches

It should be noted that the x and y distances are measured from the top of the stream of water; if y is measured in the field from the top of the pipe, the pipe

thickness and freeboard must be *subtracted* from the measured y to obtain the *correct* value of y.

b. *Fountain flow.* The flow from a vertical pipe can be approximated by measuring the height of the use of the stream of water above the top of the pipe (fig. F-8). Two types of flow must be recognized when dealing with fountain flow. At low crest heights, the discharge has the character of weir flow, while at high crest heights the discharge has the character of jet flow. Intermediate values result in erratic flow with respect to the height of the crest H.

(1) Where the flow exhibits jet character, it can be computed from

$$Q = 5.68KD^2\sqrt{H} \tag{F-5}$$

where

Q = flow, gallons, per minute

K = constant varying from 0.87 to 0.97 for pipes 2 to 6 inches in diameter and h = 6 to 24 inches

D = inside pipe diameter, inches

H = vertical height of water jet, inches

Where the flow exhibits weir character, it can be approximated by using the Francis Formula, $Q = 3.33 Bh^{3/2}$, with B being the circumference of the pipe.

(2) Some values of fountain flow for various nominal pipe sizes and heights of crest are given in table F-1.

F-4. Open channel flows.

a. *Weirs.* Flow in open channels can be measured by weirs constructed in the channel. Certain dimensional relations should be recognized in constructing a weir to obtain the most accurate flow measurements as shown in figure F-9. The weir plate should be a non-corrosive metal about 1/4 inch thick with the crest 1/8 inch wide, and the downstream portion of the plate beveled at 45 degrees, The crest should be smooth, and the plate should be mounted in a vertical plane perpendicular to the flow. The channel walls should be

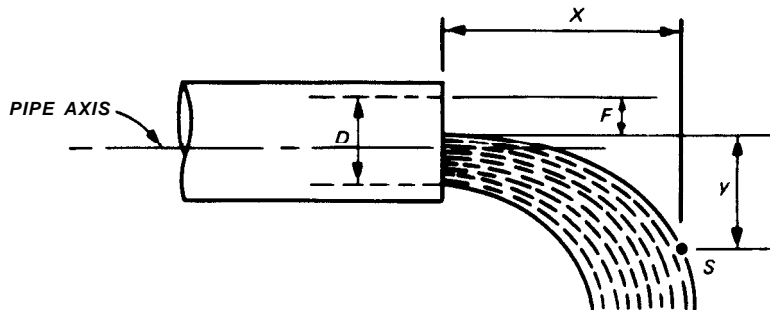

U.S. Army Corps of Engineers

Figure F-6. Flow from pipe.

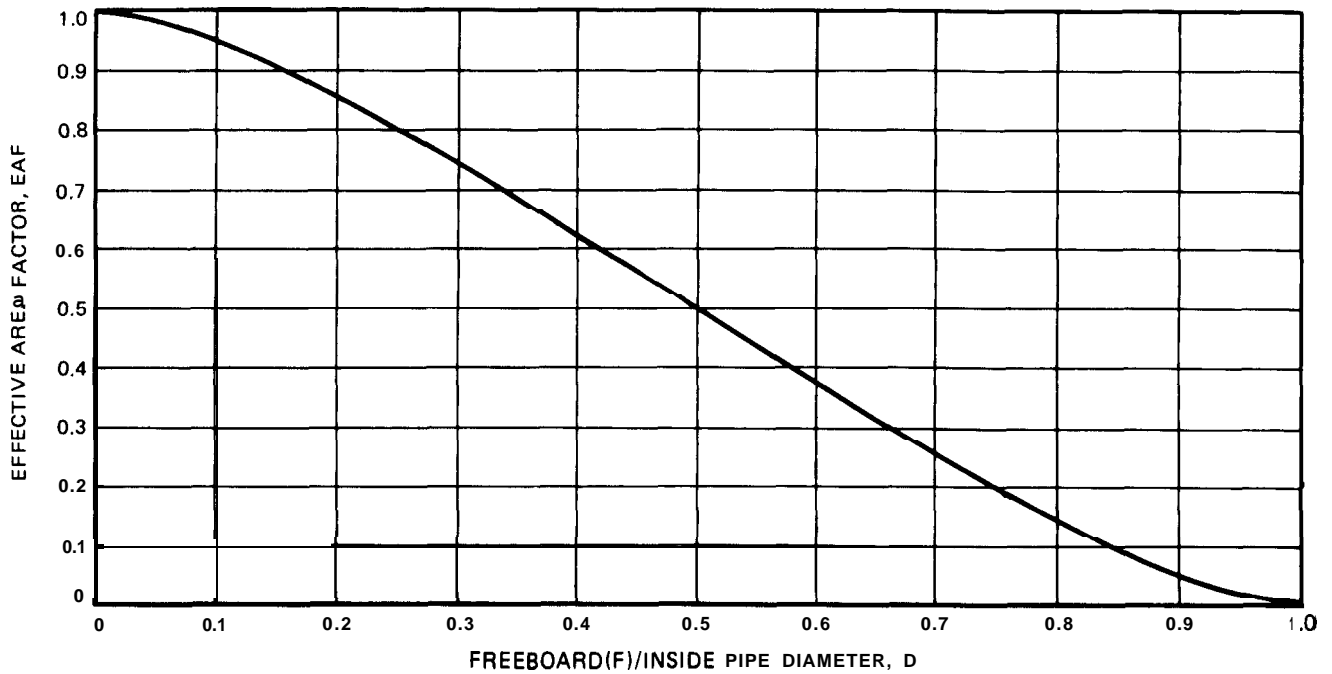

U. S. Army Corps of Engineers

Figure F-7. Effective area factor for partially filled pipe.

Table F-1. Flow (gallons per minute) from Vertical Pipes

Height of Crest H inches	Nominal Diameter of Pipe, inches					
	2	3	4	5	6	8
1-1/2	22	43	68	85	110	160
2	26	55	93	120	160	230
3	33	74	130	185	250	385
4	38	88	155	230	320	520
5	44	99	175	270	380	630
6	48	110	190	300	430	730
8	56	125	225	360	510	900
10	62	140	255	400	580	1050
12	69	160	280	440	640	1150
15	78	175	315	500	700	1300
18	85	195	350	540	780	1400
21	93	210	380	595	850	1550
24	100	230	400	640	920	1650

U.S. Army Corps of Engineers

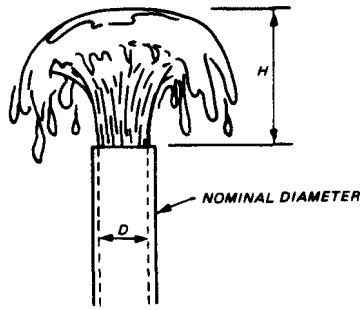

U. S. Army Corps of Engineers

Figure F-8. Fountain flow measurement.

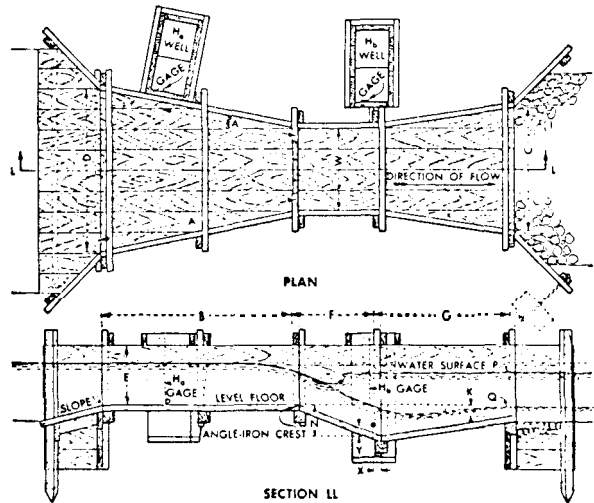

(Courtesy of Fairbanks Morse, Inc., Pump Division)

Figure F-11. Plan and elevation of the Parshall measuring flume.

smooth and parallel, and extend throughout the region of flow associated with the weir. Complete aeration of the nappe is required for rectangular suppressed weirs. The approach channel should be of uniform section and of a length at least 15 times the maximum head on the weir. Smooth flow to and over the weir is essential to determination of accurate rates of flow. The head on the weir should be measured with a hook gage located in a stilling box at the side of the approach channel. The communication pipe to the stilling box should be about 1 1/2 inches in diameter and should be flush with the side of the channel. Formulas for calculating the flow over various types of weirs are shown in figure F-10.

b. Parshall flume. Flow in an open channel may also be measured with a Parshall flume (fig. F-11). The head drop through the flume is measured by two gages (fig. F-11); but if the depth of water at the lower gage is less than 70 percent of the depth at the upper gage, the flow is termed "free" and the discharge can be determined by reading the upstream hook gage alone. The construction and dimensions of a Parshall flume are shown in figure F-11 and table F-2. The free flow discharge of a Parshall flume is given in table F-3.

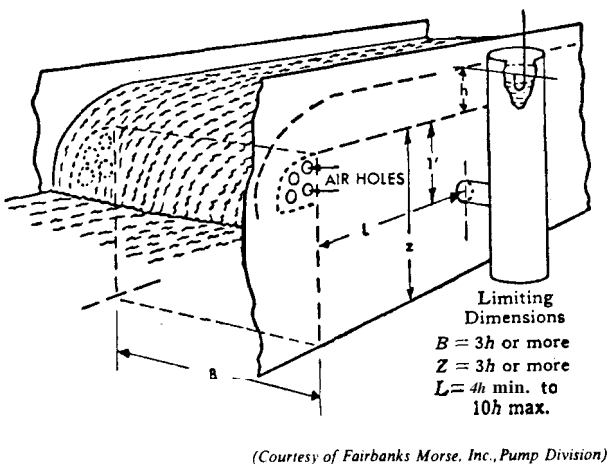

(Courtesy of Fairbanks Morse, Inc., Pump Division)

Figure F-9. Rectangular suppressed weir.

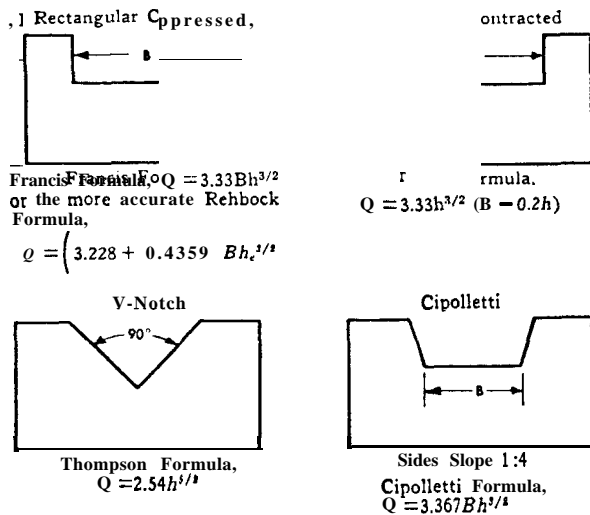

(Courtesy of Fairbanks Morse, Inc., Pump Division)

Figure F-10. Formulas for computing flow over various types of weirs.

Table F-2. Dimensions and Capacities, Parshall Flumes.

Throat Width	A	½ A	B	C	D	E	F	G	K	N	X	Y	Free Flow Cu.ft./Sec.	
													Max.	Min.
0'3"	1'6¾"	1'0¼"	1'6"	0'7"	0'10⅞"	1'4"	½'	1'	1"	2¼"	1"	1½"	1.1	0.03
0'6"	2'0⅞"	1'4⅞"	2'0"	1'3⅝"	1'3⅝"	2'0"	1'	2'	3"	4½"	2"	3"	3.9	0.05
0'9"	2'10⅝"	1'11⅜"	2'10"	1'3"	1'10⅝"	2'6"	1'	1½'	3"	4½"	2"	3"	8.8	0.09
1'0"	4'6"	3'0"	4'4⅞"	2'0"	2'9¼"	3'0"	2'	3'	3"	9"	2"	3"	16.1	0.35
1'6"	4'9"	3'2"	4'7⅞"	2'6"	3'4⅜"	3'0"	2'	3'	3"	9"	2"	3"	24.6	0.51
2'0"	5'0"	3'4"	4'10⅞"	3'0"	3'11½"	3'0"	2'	3'	3"	9"	2"	3"	33.1	0.66
3'0"	5'6"	3'8"	5'4¾"	4'0"	5'1⅞"	3'0"	2'	3'	3"	9"	2"	3"	50.4	0.97
4'0"	6'0"	4'0"	5'10⅝"	5'0"	6'4¼"	3'0"	2'	3'	3"	9"	2"	3"	67.9	1.26
5'0"	6'6"	4'4"	6'4½"	6'0"	7'6⅝"	3'0"	2'	3'	3"	9"	2"	3"	85.6	2.22
6'0"	7'0"	4'8"	6'10⅝"	7'0"	8'9"	3'0"	2'	3'	3"	9"	2"	3"	103.5	2.63
7'0"	7'6"	5'0"	7'4¼"	8'0"	9'11⅝"	3'0"	2'	3'	3"	9"	2"	3"	121.4	4.08
8'0"	8'0"	5'4"	7'10⅝"	9'0"	11'1¼"	3'0"	2'	3'	3"	9"	2"	3"	139.5	4.62

(Courtesy of Fairbanks Morse, Inc., Pump Division)

Table F-3. Free-flow Discharge (in cubic feet per second), Parshall Flume.

$$Q = 4 W H_a^{1.522W^{0.026}}$$

Size of Flume, W.

Head, H _a Feet	3"	6"	9"	1'0"	1'6"	2'0"	3'0"	4'0"	5'0"	6'0"	7'0"	8'0"
0.1	.028	.05	.09
0.2	.082	.16	.26	.35	.51	.66	.97	1.26
0.3	.154	.31	.49	.64	.94	1.24	1.82	2.39	2.96	3.52	4.08	4.62
0.4	.241	.48	.76	.99	1.47	1.93	2.86	3.77	4.68	5.57	6.46	7.34
0.5	.339	.69	1.06	1.39	2.06	2.73	4.05	5.36	6.66	7.94	9.23	10.51
0.6	.450	.92	1.40	1.84	2.73	3.62	5.39	7.15	8.89	10.63	12.36	14.08
0.7	.571	1.17	1.78	2.33	3.46	4.60	6.86	9.11	11.36	13.59	15.82	18.04
0.8	.702	1.45	2.18	2.85	4.26	5.66	8.46	11.25	14.04	16.81	19.59	22.36
0.9	.843	1.74	2.61	3.41	5.10	6.80	10.17	13.55	16.92	20.29	23.66	27.02
1.0	.992	2.06	3.07	4.00	6.00	8.00	12.00	16.00	20.00	24.00	28.00	32.00
1.1	2.40	3.55	4.62	6.95	9.27	13.93	18.60	23.26	27.94	32.62	37.30
1.2	2.75	4.06	5.28	7.94	10.61	15.96	21.33	26.71	32.10	37.50	42.89
1.3	4.59	5.96	8.99	12.01	18.10	24.21	30.33	36.47	42.62	48.78
1.4	5.14	6.68	10.10	13.48	20.32	27.21	34.11	41.05	47.99	54.95
1.5	7.41	11.20	15.00	22.64	30.34	38.06	45.82	53.59	61.40
1.6	8.18	12.40	16.58	25.05	33.59	42.17	50.79	59.42	68.10
1.7	8.97	13.60	18.21	27.55	36.96	46.43	55.95	65.48	75.08
1.8	9.79	14.80	19.90	30.13	40.45	50.83	61.29	71.75	82.29
1.9	10.62	16.10	21.63	32.79	44.05	55.39	66.81	78.24	89.76
2.0	11.49	17.40	23.43	35.53	47.77	60.08	72.50	84.94	97.48
2.1	12.37	18.80	25.27	38.35	51.59	64.92	78.37	91.84	105.40
2.2	13.28	20.20	27.15	41.25	55.52	69.90	84.41	98.94	113.60
2.3	14.21	21.60	29.09	44.22	59.56	75.01	90.61	106.20	122.00
2.4	15.16	23.00	31.09	47.27	63.69	80.25	96.97	113.70	130.70
2.5	16.13	24.60	33.11	50.39	67.93	85.62	103.50	121.40	139.50

NOTE: Approximate values of flow for heads other than those shown may be found by direct interpolation in the table.

(Courtesy of Fairbanks Morse, Inc., Pump Division)

APPENDIX G

EXAMPLES OF DETAILED DEWATERING SPECIFICATIONS

G-1. General. This appendix provides examples based on actual specifications for installation of dewatering or pressure relief systems, extracted from Government and private industry contract documents. They have been selected and presented to illustrate the various types of specifications described in the test (para 7-2).

G-2. Types of specifications.

a. Type A specifications are projects where the dewatering is not too critical with respect to damage to the permanent work or safety to personnel, and only the desired results are to be specified. This type of specifications makes the Contractor completely responsible for design, installation, and operation of the system(s). Specifications may be brief (type A-1) or more detailed (type A-2), depending upon complexity and criticality of the dewatering or pressure relief system. The examples of these two types are from Corps of Engineers projects.

b. Type B specifications are recommended for large, complex systems, or where the dewatering or pressure relief is critical with regard to construction of the project, damage to permanent work, and safety.

(1) *Type B-1.* A specification that gives a detailed design and requirements for installation of a "minimum" system but makes the Contractor responsible for operating and maintaining the system, supplementing it as necessary to obtain the required results. The installation is then checked with a full-scale pumping test to verify its adequacy.

(2) *Type B-2.* A specification that gives a detailed design and installation procedure but makes the Contractor responsible only for normal repairs and operations. The Government or Owner thus assumes the responsibility for the adequacy of the system and its components, major repairs, and replacement of equipment if necessary.

(3) *Type B-3.* A specification that is similar to type A, wherein only the desired results are specified, except the degree of difficulty or criticality of the system requires that the Contractor retain an "Expert" in the field of dewatering or pressure relief systems to design, supervise installation, and monitor the system.

c. Types A-1 and B-3 specifications should not be used unless the issuing agency has considerable confidence in the (dewatering) qualification of the bidders;

ample time and knowledge to check the Contractor's submittals; and a willingness to reject the Contractor's proposals and accept any associated delays in starting the project until an acceptable design is submitted.

d. For large and complex dewatering projects where dewatering is critical to the safety of the work, type B-1 specifications are recommended; types A-2 and B-3 may be suitable if the Owner or Engineer can or will enforce the provisions relating to approval of design, installation, and operation.

G-3. Example of type A-1 specifications (dewatering).

a. *General.* The Contractor shall provide all dewatering necessary to keep the construction and work areas dry. The Contractor shall design, install, operate, and maintain an adequate system. The system shall be of sufficient size and capacity to maintain a dry condition without delays to construction operations.

b. *Submittals.* The Contractor shall submit a *proposed dewatering plan* for approval of the Contracting Officer prior to initiation of any construction or excavation operations. The plan shall show all facilities proposed for complying with this section.

c. *Payments.* Payment for all work covered in this specification will be made at the contract lump sum price for "dewatering," which price shall constitute full compensation for furnishing all plant, equipment, labor, and materials to install, operate, maintain, and remove the dewatering system.

G-4. Example of type A-2 specifications (dewatering).

a. *Scope.* This section covers the design, furnishing, installation, operation, maintenance, and removal of a dewatering system, complete.

b. *Dewatering.*

(1) *General.* The dewatering system shall be of a sufficient size and capacity as required to control hydrostatic pressure on all clay strata below elevation - 13.0 feet to depths indicated by the logs of borings, to permit dewatering of the area specified in paragraph d below, and to allow all material to be excavated, piles driven, and concrete placed, all in a dry condition. The system shall include a deep-well system, a wellpoint system, other equipment, appurte-

nances, and related earthwork necessary for the required control of water. The sequence of installation of components of the dewatering system shall be in accordance with the specifications and drawings. The system shall remain in continuous operation, as specified, until a written directive to cease dewatering operations has been received from the Contracting Officer.

(2) *Control of water.* The Contractor shall control, by acceptable means, all water regardless of source. Water shall be controlled and its disposal provided for at each berm. The entire periphery of the excavation area shall be ditched and diked to prevent water from entering the excavation. The Contractor shall be fully responsible for disposal of the water and shall provide all necessary means at no additional cost to the Government.

c. *Design.* The dewatering system shall be designed using accepted and professional methods of design and engineering consistent with the best modern practice. The dewatering system shall include the deep wells, wellpoints, and other equipment, appurtenances, and related earthwork necessary to perform the function. A representative of the Contractor shall visit the site to determine the conditions thereof. The Contractor shall be responsible for the accuracy of the drawings and design data required hereinafter.

(1) *Drawings and design data.* The Contractor shall submit for the approval of the Contracting Officer, within 30 calendar days after receipt of Notice to Proceed, drawings and complete design data showing methods and equipment he or she proposes to utilize in dewatering, including relief of hydrostatic head, and in maintaining the excavation in a dewatered and in a hydrostatically relieved condition. The material to be submitted shall include, but not necessarily be limited to, the following:

(a) Drawings indicating the location and size of berms, dikes, ditches, all deep wells, observation wells, wellpoints, sumps, and discharge lines, including their relation to water disposal ditches.

(b) Capacities of pumps, prime movers, and standby equipment.

(b) Design calculations proving adequacy of system and selected equipment.

(d) Detailed description of dewatering procedure and maintenance method.

(2) *Responsibility.* Approval by the Contracting Officer of the plans and data submitted by the Contractor shall not in any way be considered to relieve the Contractor from full responsibility for errors therein or from the entire responsibility for complete and adequate design and performance of the system in controlling the water level in the excavated area and for control of the hydrostatic pressures to the depths hereinbefore specified. The Contractor shall be solely responsible for proper design, installation, proper

operation, maintenance, and any failure of any component of the system.

d. *Dewatering system,*

(1) *Deep-well system.* The clay and sand strata below elevation -13.0 feet are continuous over a large area. Removal of soils above elevation -25.0 feet. A deep-well system shall be provided to relieve this pressure. The pressure shall be relieved in the sand strata such as those indicated on boring S-II-SS-1-62(A) from 67.5 to 72.0 feet and from 85.5 to 142.5 feet. These strata will vary in elevation and thickness over the area. The deep-well system shall be of sufficient capacity to lower the hydrostatic head to elevation -40.0 feet as measured in observation wells at nine points in the excavation. One installed spare deep well, complete and ready for immediate operation, shall be provided for each two operating wells. The use of gas-line prime movers will not be permitted in the operation of deep wells. At each of the nine points two observation wells shall be installed. One observation well shall be installed with the screen in the upper sands, and one observation well shall be installed with the screen in the lower sands. The riser pipe for the observation wells will be 2-inch pipe in 5-foot sections. One of the observation points shall be constructed at coordinate N254 460, E260 065. The remainder of the observation points will be located by the Contracting Officer after the dewatering plan is submitted. The exact tip elevation of all observation wells will be established after the dewatering plan is submitted; however, the tip elevation in the lower sand will be at least 100 feet below original ground surface, and the tip elevation of the observation wells in the upper sands will be approximately 70 feet below original ground surface. The Contractor shall maintain the observation wells and keep daily records of readings until otherwise directed by the Contracting Officer.

(2) *Wellpoint system.* A wellpoint system shall be used above the top of clay shown on the borings at approximate elevation -14.0 feet but to dewater the area from original ground surface to the top of the clay. This system shall have sufficient capacity to lower the head within the excavation to the top of the clay.

e. *Available soil test data and pumping test data.* The soil test data obtained by the Government are shown on the boring logs. Additional laboratory data and samples of the soils from borings shown in the plans are available in the District office for inspection by bidders. Typical permeability data from laboratory tests at this site are tabulated. Pumping tests have not been made at the site; however, the soil profile at the B-1 and B-2 test stand excavation is similar to this site and this excavation is now being dewatered by a deep-well system. Data on this system can be inspected

at the office of the Area Engineer or in the District office.

f. Standby equipment. The Contractor shall furnish standby pumping equipment power as follows:

(1) Diesel, liquid petroleum gas, and gasoline fueled prime movers for pumps shall have 50 percent standby equipment.

(2) Portable electric generators shall have 100 percent standby generating equipment.

(3) Commercial electric power, which is available at the site, shall have 100 percent standby electric generating equipment.

(4) The Contractor shall provide not less than one complete spare pumping unit for every five pumping units other than deep-well pumps in the system. In no case shall less than one standby pumping unit be provided. The sizes of the standby pumping units shall be subject to the approval of the Contracting Officer.

g. Damages. The Contractor shall be responsible for, and shall repair without cost to the Government, any damage to work in place, the other Contractors' equipment, and the excavation, including damage to the bottom due to heave and including removal of material and pumping out of the excavated area that may result from his or her negligence, inadequate or improper design and operation of the dewatering system, and any mechanical or electrical failure of the dewatering system.

h. Maintaining excavation in dewatered condition.

(1) *General.* Subsequent to completion and acceptance of all work, including piling and concrete work, in the excavated area, the Contractor shall maintain the excavation in a dewatered condition and the water level in the observation wells at the specified and approved elevation until such time as the succeeding Contractor commences dewatering operations, and a written directive to cease pumping operations has been received from the Contracting Officer. System maintenance shall include but not be limited to 24-hour supervision by personnel skilled in the operation, maintenance, and replacement of system components; standby and spare equipment of the same capacity and quantity as specified in *f* above; and any other work required by the Contracting Officer to maintain the excavation in a dewatered condition. Dewatering shall be a continuous operation and interruptions due to outages, or any other reason, shall not be permitted.

(2) *Responsibility.* The Contractor shall be responsible for all damages to accepted work in the excavation area and for damages to any other area caused by his or her failure to maintain and operate the system as specified above or from water overflowing his or her ditch.

i. System removal. Upon receipt of written directive to cease dewatering operations from the Contracting

Officer, the Contractor shall remove all dewatering equipment from the site, including related temporary electrical secondary as approved by the Contracting Officer. All wells shall be plugged and/or filled, Removal work required under this paragraph does not include any of site cleanup work as required elsewhere in these specifications.

j. Method of measurement. Dewatering, as specified in *k(2)* below, to be paid for will be determined by the number of calendar days (24 hours), counted on a day-to-day basis, the excavation is maintained in a dewatered condition, measured to the nearest hour, from completion and final acceptance of the concrete foundation for the A- 1 test stand area to the date on which a written directive to cease pumping operations is received from the Contracting Officer.

k. Payment.

(1) *Dewatering during excavation and construction.* Payment for furnishing all designs and engineering data, plant, labor, equipment, material, and appurtenances and for performing all operations in connection with designing, furnishing, installing, operating, and maintaining the dewatering system until the work in the area is completed and accepted will be made at the applicable contract lump sum price for "Dewatering A-1 Test Stand Area, Deep Wells," and "Dewatering A-1 Test Stand Area, Except for Deep Wells." Twenty-five percent of the contract price for each item will be paid upon completion of the installation of the dewatering system for the excavation. A second 25 percent of the contract price for each item will be paid upon satisfactory completion of 80 percent of the estimated excavation quantity. A third 25 percent of the contract price for each item will be paid upon satisfactory completion of 100 percent of the required excavation. Fifteen percent of the contract price for each item will be paid when final acceptance of all work in the excavation is made. The remaining 10 percent of the contract price for each item will be paid after written notice to cease dewatering operations has been issued and final cleanup and final acceptance of all work has been made.

(2) *Maintaining area in dewatered condition.* Payment for furnishing all plant, labor, equipment, and material and for performing all operations in connection with maintaining the accepted excavations in a dewatered condition will be made at the applicable contract unit price per calendar day for "Maintaining A-1 Test Stand Excavation in Dewatered Condition." No payment will be made for this item for periods, measured to nearest hour, during which the dewatering system is not operated and maintained as specified hereinbefore.

(3) *Removal of systems.* Payment for furnishing all plant, labor, equipment, and material and for performing all operations in connection with removal of

the dewatering system will be made at the applicable contract lump sum price for "Removal of A-1 Test Stand Dewatering System." However, if the Contractor so elects to sell the installed and operating system to the succeeding Contractor or to dispose of the system in place by other means, as approved by the Contracting Officer, the Contractor shall be relieved from the requirements of the specified removal work and no payment will be made for this item.

G-5. Example of type B-1 specifications (dewatering and pressure relief).

a. Scope. This section covers furnishing, installation, operation, maintenance, and removal of the jet-eductor wellpoint and pressure relief well systems, as subsequently specified in this section; control of any seepage from the soils above the bottom of the excavation not intercepted by the jet-eductor wellpoint system deemed necessary by the Contractor to permit installation of the sheeting shown to grade as specified; pumping of surface water or seepage through the sheeting during excavation or after the jet-eductor dewatering system is turned off or removed; and installing any additional pressure relief wells, pumps, and appurtenances, if necessary, to maintain the hydrostatic water level in the clayey silty sand and sandy silt (semipervious) stratum (about el 235± 1 foot) beneath the excavation at all times.

b. Responsibility. The Contractor shall be fully responsible for furnishing, installing, operating, maintaining, and removing all wellpoint, pressure relief, and seepage or surface water control systems. However, any pressure relief wells, pumps, piping, and electrical wiring and controls required to lower and maintain the hydrostatic water level in the semipervious stratum below the bottom of the excavation, other than the pressure relief system specified, will be paid for as an extra.

(1) The Contractor shall be responsible for:

(a) Installing and testing the wellpoint and pressure relief systems as specified.

(b) Dewatering or controlling any seepage from the soils above the bottom of the excavation so that the sheeting may be installed without any significant sloughing of earth during excavation and placement of sheeting and pea gravel backpack.

(c) Maintaining the hydrostatic water level in the semipervious stratum below elevation 250.0 feet at all times.

(d) Maintaining the bottom of the excavation free of all seepage or surface water until the structural mat has been placed and the waterproofing installed up to the top of the mat.

(e) Operating, maintaining, and monitoring the wellpoint and pressure relief well systems. System maintenance shall include but not be limited to at least

daily supervision by someone skilled in the operation, maintenance, and replacement of system components; at least one spare submersible pump and controls and one pressure pump of the same capacity as specified; and any other work required by the Contracting Officer to maintain the excavation in a dewatered and hydrostatically relieved condition. Dewatering and pressure relief shall be a continuous operation and interruptions due to power outages, or any other reason, shall not be permitted. Some responsible person shall also monitor the dewatering sump pumping, and pumping the relief wells continuously until the succeeding contractor assumes the responsibility for such, and the Contractor has received a written instructive that he or she is no longer responsible for this operation.

(2) The Contractor shall also be fully responsible for any failure of any component of the systems. The Contractor shall be responsible for all damages to work in the excavation area and for damages to any other area caused by failure to maintain and operate the dewatering and pressure relief systems as specified.

c. Wellpoint and pressure relief systems.

(1) *General.* The jet-eductor wellpoint system specified is to lower the groundwater table adjacent to the excavation and intercept seepage from the sandy and gravelly soil above the Cockfield formation (at about el 253.0 feet) so that excavation and placement of the wood sheeting and pea gravel backpack can be accomplished with minimum difficulty, and with little if any sloughing of the soil from the cut slope. The wellpoint system combined with a sump ditch between the sheeting and edge of structural mat when properly installed, maintained, and pumped should permit placing the "mud" mat on foundation soils free of any surface water. If the Contractor considers the spacing of the wellpoints inadequate to accomplish the excavation and placement of the wood sheeting, as specified, he or she should space the wellpoints closer. The wellpoint system shall remain in continuous operation until the excavation has been dug to grade and the "mud" mat poured. After the "mud" mat has been placed, the wellpoint system may be turned off and any seepage through the wood sheeting removed by sump pumping. After the "A" piezometers for monitoring the groundwater table above the Cockfield formation and the wellpoint system have been installed, the system shall be tested for flow and groundwater lowering prior to starting any excavation. The well system is to relieve excess hydrostatic pressure in the semipervious stratum below the excavation to insure no heave of the soil strata above this stratum. It is imperative that no heave of the soil strata above the semipervious stratum occur inasmuch as the building will be founded directly on the foundation soils above this stratum.

(2) *Control of water.* The Contractor shall control all surface water, any seepage into the excavation, and hydrostatic pressure in the semipervious stratum beneath the excavation, regardless of source. Any opening in the wood lagging, through which seepage is carrying any soil, shall be promptly caulked. Any water seeping, falling, or running into the excavation as it is dug shall be promptly pumped out. The entire periphery of the excavation area shall be suitably diked, and the dike maintained, to prevent any surface water from running into the excavation. The Contractor shall be fully responsible for disposal of all water from the excavation and from the wellpoint and relief well systems in an approved manner at no additional cost to the Government.

(3) *Wellpoint and pressure relief system data.* The Contractor shall submit for approval by the Contracting Officer, within 10 calendar days after receipt of Notice to Proceed, complete information regarding motor generator, pumps, wellpoints, jet-eductors, well screens, and any other equipment that he or she proposes to utilize in dewatering and relieving hydrostatic pressure, and in maintaining the excavation in a dewatered and hydrostatically relieved condition. The data to be submitted shall include, but not necessarily be limited to, the following:

(a) Characteristics of pumps and motor generator, and types and pertinent features of well screens, wellpoints, and jet-eductor pumps.

(b) Plans for operating, maintaining, and monitoring the wellpoint and relief well systems.

(4) *Jet-eductor wellpoint system.*

(a) The soils at the site consist essentially of fill, clays and silts, and some silty sand and clay sands with occasionally pea gravel above the Cockfield formation. The jet-eductor wellpoint system has been designed to lower the groundwater table and intercept most of the seepage that will flow toward the excavation. Because of the impervious Cockfield formation at about the bottom of the excavation, it is not possible to lower the groundwater table and intercept most of the seepage that will flow toward the excavation as it is dug. Because of the impervious Cockfield formation at about the bottom of the excavation, it is not possible to lower the groundwater table completely down to the top of this stratum or to intercept all seepage above it. By proper installation, the jet-eductor wellpoint system should intercept most of the seepage and stabilize the soil sufficiently to install the wood sheeting subsequently specified without any significant sloughing of the soil behind the sheeting prior to placement of the pea gravel backpack. The fact that some minor seepage may bypass the wellpoints should be anticipated by the Contractor. The tips for the wellpoints shall be installed approximately 12 inches below the top of the

Cockfield formation as encountered during installation of the system.

(b) The wellpoints shall have a minimum screen or slotted length of 30 inches and shall be of the "bottom suction" type. The wellpoint screens shall be of 30-mesh cloth or have #25 slots. The wellpoints shall be of a high-capacity type with a diameter of approximately 2 1/2 inches. The jet-eductor pumps and pressure and return riser pipes shall have a capacity and be operated at a pressure which will produce a minimum flow of 2 gallons per minute with a static lift of 25 feet. If the Contractor uses jet-eductor pumps with a yield capacity greater than 3 gallons per minute, it will be necessary for him to redesign the pressure and return header lines. The pressure pumps and recirculation tank shall be designed by the Contractor. The pumps shall have adequate head and pumping characteristics to match the number and capacity of the jet-eductors being used. Both the pressure and return header lines shall be provided with pressure gages at the pumps and across the excavation from the pumps. Overflow from the recirculation tank shall be arranged so that the flow from the wellpoint system can be readily measured.

(c) The filter sand to be placed around the wellpoints and up to within 10 feet of the ground surface shall be a clean, washed sand (A) having a gradation falling within the following range:

U.S. Standard Sieve Size	Filter Sand A Percent Passing
10	78-100
16	35-82
20	15-58
30	3-32
40	0-13
50	0-3

(d) The wellpoints shall be installed by a combination of driving and jetting (with a hole puncher) a 12-inch "sanding" casing to approximately 1 foot below the top of the Cockfield formation, rinsing the "sanding" casing until there is no more sediment in the casing, centering the wellpoint and lowering it to the bottom of the hole, placing Filter Sand A in the casing around the wellpoint in a heavy continuous stream up to within 10 feet of the ground surface, and then filling the remainder of the hole with a thick bentonitic grout or by pouring in a mixture of dry sand containing 10 percent granular bentonite, up to the ground surface. Before the working day is over, all wellpoints installed that day shall be pumped with a small centrifugal pump, capable of producing a 25-foot vacuum, until the effluent becomes clear. Jet water used for installing the wellpoints shall be clear polished so that return of jet water up through the sanding casing is achieved before the casing has been driven to a depth of more than about 10 feet from the surface. It may be necessary or expeditious to prebore the holes for the

wellpoints with a 10-inch auger prior to driving and jetting the 12-inch sanding casing to grade. Any such predrilling should be accomplished in a manner which will not cause any caving of the hole as it is drilled. In jetting the sanding casing for the wellpoints, provision shall be made to prevent jet water from spraying over sidewalks and streets being used for pedestrians and/or vehicular traffic, and from running over or into streets being used by such. The Contractor will be responsible for disposal of jet water in a manner satisfactory to the City and the Construction Manager.

(e) Each jet-eductor wellpoint shall be provided with a suitable strainer at the top of the pressure riser pipe to prevent the entrance of any particles, which might clog the jet-eductor nozzle, and a stopcock or valves, which will permit isolating the wellpoint to permit pressure testing and pumping the wellpoint separately if desired,

(5) *Pressure relief wells and pumps.* The pressure relief wells shall be installed at the locations specified. These wells are to reduce the hydrostatic head in the semipervious stratum below the excavation to elevation 250.0 feet or lower as measured by the B piezometers installed in this same stratum at the locations, as subsequently specified.

(a) The screens for the relief wells shall be 10 feet long and shall be installed in the semipervious stratum at about elevation 235±1 foot. The screens shall have a nominal diameter of 4 inches. They may be manufactured of slotted Schedule 40 PVC pipe, Johnson wire-wrapped screen, or other approved screen. The screens shall be covered with 30-mesh brass or stainless steel gauze or slotted with #20 slots with a minimum open area of 5 percent. The riser pipe shall also have a 4-inch nominal diameter; it may be either PVC plastic pipe or steel. The screen portion of the wells and up for a distance of 5 feet above the top of screen shall be surrounded with a clean, washed uniform filter sand (B) with the following gradation:

U.S. Standard Sieve Size	Filter Sand B Percent Passing
10	95-100
20	58-90
30	30-73
40	5-50
50	0-25
70	0-8

Suppliers who can furnish Filter Sands A and B are as follows:

Supplier	Filter Sand A	Filter Sand B
1.	—	—
2.	—	—
3.	—	—

(b) Pumps for the relief wells shall be submersible pumps suitable for installation in 4-inch nominal diameter wells with a capacity of 3 to 10 gallons per

minute at a total dynamic head (TDH) equal to 50 feet. The Contractor shall be responsible for designing and installing the electrical system for powering the submersible pumps in the relief wells. The electrical system shall meet the local electrical code and be approved by the Contracting Officer. Each pump shall be provided with a starter and fuse disconnect with a clearly visible red light mounted on the control panel that shows red when the pump is running. A motor generator with a capacity capable of starting all of the submersible pumps in the relief wells at one time shall be provided and hooked into the electrical system at all times. This generator shall be operated to keep the pumps in the relief wells running in event of power failure. It shall be maintained in first class condition, protected from the weather, and started at least twice a week to check its operating condition.

(c) The bottom of the screens for the relief wells shall be installed at or slightly below the bottom of the semipervious stratum as encountered during installation. They shall be installed using the same procedure as specified for the wellpoints except that in all probability it will be necessary to predrill the holes to grade with a 10-inch auger because of the difficulty in jetting through some of the clay strata to be penetrated. After the (12-inch) sanding casing has been driven and jetted to grade, the well screen and riser pipe shall be centered accurately and lowered to within 1 foot of the bottom of the casing. Filter Sand B poured into the sanding casing around the well riser pipe in a heavy steady stream until the filter sand is at least 5 feet above the top of the screen; the remainder of the hole may be filled with clean medium sand. The sanding casing shall then be immediately pulled. After the well has been installed, it shall be promptly pumped with a centrifugal pump capable of producing a 25-foot vacuum until the effluent is clear. The submersible pump then shall be lowered and suspended in the well with the intake of the pump at about the top of the well screen. The pump or discharge pipe shall be provided with a check valve, and the connection between the discharge pipe from the pump to header pipe shall be provided with a gate valve which will permit removal of the pump if necessary. The top of the well shall be sealed with a suitable well cap or plate provided with a hole through which a sounding line may be lowered to determine the water level in the well when testing and monitoring the system. A full-scale pumping test shall be run on the completed system to determine its adequacy and pumping rate. This test shall be run for a minimum of 6 hours. The water level in the B piezometers and in the wells and flow from the system shall be measured at the following intervals after the start of pumping: 10 minutes, 30 minutes, 1 hour, 2 hours, 3 hours, 4 hours, and 6 hours.

(d) All of the submersible pumps shall be new,

and one new spare pump and controls shall be at the job site at all times. The electrical system and controls shall be designed so that failure of any one pump, or the need to disconnect and replace a pump, does not adversely affect operation of any other pump.

(e) The Contractor shall be responsible for recording the results of the pumping tests on the well system and furnishing them to the Construction Manager. He shall also advise the Construction Manager at least three days in advance of making this test so that a representative of the Government can observe the test.

(f) Because of the importance of preventing any significant artesian head in the semipervious stratum above the bottom of the excavation, tees shall be installed in the riser pipe for the deep wells to provide relief of this artesian pressure in event of any pump or electrical failure. These tees shall be provided with plugs during installation of the wells; as the excavation is carried down to each tee, the plug in that tee shall be removed and a Z-inch pipe with brass check valve inserted in the tee so that water can flow into the excavation. As each tee is connected into the excavation, the tee above shall be sealed.

(g) Installation of the wellpoint and the relief well systems shall be supervised by someone with at least 5 years actual experience in installing such systems. A log of each relief well shall be maintained by the Contractor; forms for logging installation of the wells will be furnished by the Contracting Officer.

(6) **Piezometers.** Piezometers shall be installed at the locations specified to measure the groundwater table in the line of wellpoints and in the excavation (A piezometers), and to measure the hydrostatic water level in the semipervious stratum beneath the excavation (B piezometers). The tips of the A piezometers shall be set at the top of the Cockfield formation; the tips of the B piezometers shall be set in the middle of the semipervious stratum. The A piezometers shall be surrounded with Filter Sand A; the tips of the B piezometers shall be surrounded with Filter Sand B. The A piezometers shall be installed using the same equipment and procedure specified for installing the wellpoints; the B piezometers shall be sealed with an expanding cement bentonite grout up to at least elevation 252.0 feet. After sealing around a B piezometer, the sanding casing shall be checked to see if there is any bentonite or cement in the casing; and if such exists, the casing shall be thoroughly washed prior to installation of the next piezometer.

(a) The piezometers shall consist of a 1.50-inch inside diameter (I.D.) (Sch 40 or 80) PVC screen with 0.025- to 0.030-inch slots connected to 1.50-inch I.D. (Sch 40 or 80) PVC riser pipe. Screens shall be 5 feet long. The joints of the screen and riser shall be flush (inside and outside) and shall be glued together with

PVC pipe cement. The top of the riser shall be cut off 30 inches above the ground surface and provided with a threaded cap with a 1/2-inch hole in the side. The upper part of the piezometer shall be protected by installing a 6-inch I.D. cardboard casing around the riser embedded 2 feet below the ground surface and filling the casing with concrete. After removal of the cardboard casing, the top 30 inches of each piezometer shall be painted day-glo orange, and the piezometer number marked in 3-inch-high black characters.

(b) Each piezometer shall be pumped after installation and then checked to determine if it is functioning properly by filling with water and observing the rate of fall. For the piezometer to be considered acceptable it shall pump at a rate of at least 0.5 gallon per minute, or when the piezometer is filled with water, the water level shall fall approximately half the distance to the groundwater table in a time less than the time given below for various types of soil:

<i>Type of Soil in which piezometer screen is wet</i>	<i>Period of observation minutes</i>	<i>Approximate time of 50 percent fall, minutes</i>
Sandy silt (>50% silt)	30	30
Silty sand (<50% silt, >12% silt)	10	5
Fine sand (<12% silt)	5	1

If the piezometer does not function properly, it shall be developed by air surging or pumping with air if necessary to make it perform properly.

d. **Available soil data.** Generalized soil profiles and logs of boring were made for Government. Samples of the soils from the borings made by _____ are available for inspection by bidders at _____

e. **Damages.** The Contractor shall be responsible and shall repair any damage to the excavation, including damage to the bottom due to heave, that may result from his or her negligence, improper operation of the dewatering and pressure relief systems, and any mechanical or electrical failure of the systems.

f. **Maintaining excavation unwatered and pressure relieved.** Subsequent to completion and acceptance of all work in the excavated area, the Contractor shall maintain the excavation unwatered and the water level in the B piezometers at or below elevation 250.0 feet until placement of the structural mat is complete and the backfill has been placed to elevation 256.0 feet, and a written directive to cease pumping has been received from the Contracting Officer. The Contractor shall be responsible for maintaining the excavation unwatered and pressure relieved during this period as set for above except for operation of the wellpoint system.

g. **Removal of wellpoint system.** After excavation to grade, installation of drainage ditch, sump pump, and placement of the "mud" mat, the wellpoint system may be removed, Removal of the wellpoint dewatering sys-

tern shall include pulling all of the wellpoints and related header pipes, pumps, recirculation tank, and temporary electrical secondary, as approved by the Contracting Officer. Any holes remaining after pulling the wellpoints shall be filled with sand. Sump pumping of seepage and surface water thereafter shall continue as required to keep the excavation in an unwatered condition until all structural concrete work and backfill are complete, and the succeeding Contractor has assumed responsibility for maintaining the excavation in an unwatered condition.

h. Method of measurement. Dewatering, as specified in *f* above, to be paid for will be determined by the number of calendar days (24 hours), counted on a day-to-day basis, the excavation is maintained in an unwatered condition and pressure relieved, from completion and final acceptance of the concrete mat to the date on which a written directive to cease pumping operations is received from the Contracting Officer.

i. Unit price. Any pressure relief wells and related appurtenances required in addition to the specified pressure relief system shall be paid for at the unit price for "additional pressure relief wells."

G-6. Example of type B-2 specifications (dewatering and pressure relief).

a. Scope. This section covers: furnishing, installing, operating, and maintaining the dewatering systems shown on the drawings and specified herein; unwatering the Phase I excavation; installing any additional dewatering wells, pumps, and appurtenances, if necessary, to lower and maintain the hydrostatic water level in the sand formation beneath the excavation to a level at least 5 feet beneath any Phase II excavated surfaces, and have the capacity to lower the water level to elevations - 29.0 and - 35.0 feet beneath the chamber and gate bay sections, respectively, of the lock for a Red River stage of elevation 60.0 feet; and controlling seepage from the soils above and below the bottom of the excavation, not intercepted by the specified well and jet-eductor systems, by installing additional jet-eductor wells, wellpoints, pumps, and appurtenances if necessary, so as to assure a stable bottom at grade for the Phase II excavation and prevent any significant seepage or raveling of excavated slopes. The dewatering systems shall include deep wells; jet-eductor wells; wellpoints and/or sand drains if required; pumps, engines, and piping; and related appurtenances; and dikes, ditches, sumps, and pumps necessary for control of surface water. The dewatering systems shall remain in continuous operation, as specified, until completion of this (Phase II) Contract and the systems are transferred to the Phase III Contractor or to the Government.

b. Compliance with specifications and drawings.

The contractor shall designate a representative or engineer experienced in dewatering large excavations whose responsibility will be to assure that the dewatering systems comply with the contract plans and specifications with respect to materials, installation, maintenance, and operation of the dewatering systems so as to control subsurface pressures, groundwater and seepage, and surface water, and maintain records as specified herein. The "dewatering" engineer's duties shall include the following:

(1) *Materials and equipment.* The Contractor's "dewatering" engineer shall obtain all specified data and supervise making all tests and/or measurements to determine that all materials incorporated in the work are in accordance with the plans and specifications. Materials and equipment to be checked shall include, but not be limited to, well screens, riser pipes, filter sand, pumps, column pipe, gear drives, couplings, diesel engines, well discharge pipe and fittings, header pipe, valves, discharge system outlet structures, piezometers, and related appurtenances.

(2) *Installation.* The Contractor's "dewatering" engineer shall check to be sure that specified procedures and methods for installing wells, pumps, jet-eductor wells, piezometers, and any other supplemental dewatering or groundwater control system required are installed in accordance with the specifications and drawings.

(3) *Operation and maintenance.* The Contractor's "dewatering" engineer shall supervise the operation and maintenance of the dewatering systems, supplemental groundwater control facilities if any, surface water control systems, and shall assist with obtaining all required piezometric, well performance, and flow data. The Contractor shall inspect the test starting of each nonoperating dewatering pump and engine installed in a well or on the system on a weekly basis and include in a daily report reference to the conduct of the test, the number of pumps and engines tested, and any unsatisfactory performance data and remedial action taken. The Contractor's "dewatering" engineer shall notify the Contractor and the Contracting Officer's Representative (C.O.R.) immediately of any event or information not in accordance with the specifications. Thirty days prior to completion of the work under this contract, the Contractor shall furnish to the Government a complete set of "as-built" drawings of the dewatering facilities installed, and all significant operational, maintenance, and performance data and records.

(4) *Records.* A copy of all inspection and test data relating to materials, installation, operation and maintenance, and performance of the dewatering systems, and supplemental groundwater control facilities if any, as required, shall be promptly furnished to the Contracting Officer.

c. *General.* The dewatering systems shall be installed, operated, and maintained so as to reduce the artesian pressure in the sand formation below the excavation, and control seepage from any excavated slopes or into the bottom of the excavation as specified below, so that the work covered under this contract can be accomplished in stable areas free of water and without heaving of soil strata overlying the sand aquifer within the cofferdammed area.

(1) *Dewatering requirements.* Construction dewatering to be performed by the Contractor shall consist of:

(a) Dewatering lock and dam excavation by pumping from deep wells; jet-educator wells; and any other supplemental groundwater control facilities if required.

(b) Unwatering the Phase I excavation.

(c) Testing adequacy of deep-well system prior to and after unwatering the Phase I excavation. Evaluation of the adequacy of the jeteducator system after unwatering the excavation.

(d) Controlling and removing of surface water falling into the excavation.

The dewatering systems for Phase II excavation for the lock and dam shall be constructed in accordance with the details shown on the drawings and the requirements herein specified. The dewatering systems shall be installed and operated by the Contractor to control seepage from any excavated slopes or the bottom of the excavation so as to assure a stable work area at grade and prevent raveling or sloughing of excavated slopes, and to lower the hydrostatic water level in the deep underlying sand formation so that as the excavation progresses the piezometric heads and groundwater table are maintained at least 5 feet below the bottom of the excavation and 3 feet below the slopes at all times, as measured by construction piezometers. After the hydrostatic water level in the deep sand formation has been lowered to the required levels beneath the excavation, it shall be maintained at the required elevations so that all testing and construction operations can be performed in the dry without interruption.

(2) *Design of dewatering systems.* The (dewatering) well system has been designed to lower the hydrostatic water level to elevation -26.0 feet in the deep sand formation beneath the excavation for the dam and to elevation - 35.0 feet beneath the lock (or below) with a river stage at elevation 60.0 feet, with as many as two to five well pumps off depending on their location.

(a) The jet-educator wells (indicated by borings made in and around the excavation) have been designed to drain semipervious soils in the top stratum to prevent or minimize any detrimental seepage from the (main) excavated slopes around the excavation. Ad-

ditional jet-educator wells may be required to control seepage from other sections of the slopes around the excavation. As shown by the boring logs and subsequently referenced reports, the stratification of the top stratum soils above the deep sands is erratic (more so in some areas than others). The deep wells and jet-educator wells, subsequently installed around the top or upper berm for the excavation, may or may not completely dewater or stabilize all slopes or areas in the bottom of the excavation. Dewatering facilities for control of groundwater in the lower part or bottom of the excavation, if required, shall be designed by the Contractor subject to approval of the Contracting Officer. Facilities for unwatering the Phase II excavation, and controlling and sump pumping surface water, shall be designed by the Contractor.

(b) The Contractor shall submit for approval by the C.O. within 15 calendar days after receipt of Notice to Proceed complete information regarding methods and equipment he or she proposes to utilize for installing the jet-educator wells and pumping the dewatering wells required by these specifications. The Contractor shall at the same time submit detailed design data and drawings for the system he or she plans for controlling surface water and unwatering the excavation for the Phase I work. The material to be submitted shall include, but not necessarily be limited to, the following: capacities and characteristics of all well and jeteducator pumps, engines, gear heads, flexible couplings, and standby equipment; description of equipment and procedures he or she proposes to use for installing the dewatering wells, jet-educator wells, and any supplemental dewatering facilities, if required, in the bottom or lower part of the excavation; calculations and drawings of dikes, ditches, sumps, pumps, and discharge piping for unwatering the Phase I excavation and for controlling surface water; and a detailed description of his or her procedures and plans for supervising the installation, operation, and maintenance of the dewatering systems to insure that the systems are installed as specified herein and that they are operated and maintained so as to preserve the systems in first class working conditions subject to normal wear, throughout the life of this contract.

(c) Approval by the Contracting Officer of the plans and data submitted by the Contractor shall not relieve the Contractor from the responsibility for controlling surface water, seepage, and artesian head and groundwater levels in the excavated areas as, and to the extent, specified herein.

(3) *Responsibility.* The Contractor shall be fully responsible for furnishing, installing, operating, and maintaining the dewatering and jet-educator well systems, as specified, and any other seepage and surface water control systems required for control of groundwater as herein specified. However, any jet-educator or

dewatering wells, pumps, piping, etc., required to control groundwater in the main excavated slopes around the excavation and in the deep sand stratum below the bottom of the excavation will be paid for as an extra. Any supplemental measures for control of seepage, whether perched or otherwise, in the bottom of the Phase II excavation or from excavated slopes in the bottom of the excavation, will *not* be paid for as an extra.

(a) The Contractor shall be responsible for: installing and testing the dewatering well and jet-educator system as specified prior to and after unwatering the Phase I excavation; unwatering the Phase I excavation; dewatering and/or controlling any seepage from specified excavated slopes or in the bottom of the excavation so as to prevent any raveling or other instability of the slopes while unwatering of the Phase I excavation and driving the test and foundation piling under this contract; maintaining the hydrostatic water level in the deep sand formation at least 5 feet below the bottom of the excavation and any excavated slopes, and controlling any detrimental seepage emerging from pervious soils in the top stratum; lowering the groundwater table in pervious or semipervious strata in the top stratum at least 3 feet below any excavated slopes except at the contact with an underlying impervious stratum; maintaining the bottom of the excavation free of all seepage or surface water until the end of this contract; and operating and maintaining the dewatering systems.

(b) The Contractor shall be responsible for installing and operating continuously the dewatering well systems specified herein, and any other supplemental wells, pumps, and engines, necessary to lower and maintain the hydrostatic head in the deep underlying sand formation 5 feet or more below any Phase II excavation, and with the capacity of lowering the groundwater table below elevation -29.0 feet in the chamber and elevation -35.0 feet in the gate bay areas for the lock, for a projected Red River stage of elevation 60.0 feet. The Contractor shall also be responsible for maintaining the groundwater table in silt, silty sand, and sand strata, penetrated by the Phase I or Phase II excavation at least 3 feet below the surface of the slope, and shall control any seepage at the contact between seeping soil strata and impervious strata occurring at any time which might otherwise cause raveling or instability of the slope at that level. Any noncompliance with the above specified groundwater control requirements shall be promptly rectified in accordance with these specifications.

(c) The Contractor shall be responsible for all damage to work in excavated areas caused by failure to maintain and operate the dewatering systems as specified.

(4) *Installation sequence.* Prior to installation of

the deep and jet-educators dewatering wells, the Contractor shall submit a plan of his or her procedures and equipment for accomplishing the work within fifteen (15) days of his or her Notice to Proceed. After receiving approval of such procedures and equipment, he or she shall install and test the above dewatering system, including unwatering the Phase I excavation, within 120 calendar days. Any apparent deficiencies in the deep or jet-educator well systems for whatever cause shall be corrected within 15 calendar days after evaluation of the pumping tests made on the systems and notification by the Contracting Officer. There shall be no unwatering of the Phase I excavation until the deep-well system has been installed and tested, and no unwatering of the excavation more than 3 to 5 feet below any reach of the uppermost berm, where jet-educator wells are to be installed, until all of the jet-educator wells specified are installed.

(5) *Testing dewatering system.* After the deep-well dewatering system has been completely installed, its adequacy shall be checked by the Contractor making a pumping test on the entire system, as directed by the C.O.R., prior to unwatering the Phase I excavation and at the completion of unwatering the Phase I excavation. The jet-educator systems shall be continuously operated while unwatering the Phase I excavation and the adequacy of its performance evaluated after completion of unwatering and as the excavation for Phase II is carried to grade. The performance of the dewatering systems will be evaluated by the Government. If the dewatering well system and jet-educator wells are found to be inadequate to control the groundwater and artesian head below the excavation, they shall be supplemented as provided for subsequently in these specifications.

(6) *Operation during contract.* The Contractor shall operate and maintain the specified dewatering well and jet-educator systems and any supplementary wells or seepage control measures that may have been installed, as needed to comply with these specifications during the complete period of this contract.

(7) *Transfer of dewatering system to Phase III Contractor.* Upon completion of this contract, the Contractor shall turn over the complete deep-well, jet-educator, and surface water control systems and all standby equipment to the Phase III Contractor or the Government who will at that time assume ownership and operation of the dewatering and surface water control systems. The Phase III Contractor will be responsible for removal of the systems in accordance with his Phase III contract.

(8) *Unwatering excavation for Phase I contract.* It will be the responsibility of the contractor to unwater the excavation made during the Phase I contract for this project. No unwatering of the excavation shall be started until after the deep-well and jet-educator dewatering

tering systems have been completely installed and initially tested. When, and if, the first full-scale pumping test conducted on the dewatering system shows the system adequate to lower and maintain the hydrostatic water level in the deep underlying foundation 3 to 5 feet below the water level in the excavation as it is unwatered, the Contracting Officer will advise in writing that the Contractor may proceed with unwatering the excavation. The water level in the Phase I excavation shall be lowered at a rate not to exceed 1 foot per day or slower if there is any sign of raveling or instability of the excavated slopes.

(9) *Surface water control.* The Contractor shall install, operate, and maintain dikes, ditches, **sumps**, pumps, and discharge piping for controlling surface water so as to prevent flooding of the work area for driving the test and foundation piles for the dam.

(10) *Available soil and pumping test data.*

(a) Some of the soil test data obtained by the Government are shown on the boring logs. Additional logs of borings made for the project are plotted in _____ dated _____. The above report and additional laboratory data and samples of soils from the borings shown on the plans are available in the _____ office of _____.

(b) Pumping tests have been performed on three wells installed at the site. One of these test wells (Well A) was installed with 190 feet of 16-inch nominal diameter well screen that more or less fully penetrated the deep sand aquifer beneath the excavation site; two of the test wells (Wells B and C) were installed to a depth of approximately 80 feet for the purpose of testing the upper top strata of silty sands and sandy silts. The locations of the test wells and some of the piezometers installed in connection with making the pumping tests are shown on the drawings. The elevation of the well screens for the test wells and piezometers and logs of borings made along the piezometer lines radiating out from the test wells were plotted. A hydrograph of the Red River and Piezometers PA9 and PA9A installed 2970 and 3970 feet from Test Well A, observed during the test on Well A, are shown on a drawing of these specifications. Plots were made of **drawdown** observed while pumping Test Well A, corrected for an estimated (natural) change in the groundwater table during these tests as a result of a rise on the Red River. Results of the pumping tests made on Test Wells B and C were also plotted. No correction was made for any natural change in the groundwater table during the pumping test on Wells B and C inasmuch as there was very little change in the river stage during the pumping test on these wells. A report on the pumping test made at the site by _____ and design of the dewatering systems may be exam-

ined at the New Orleans District Office or at the office of _____. The Government **guarantees** the accuracy of the basic river stage and pumping test data as obtained for the particular wells installed at the locations tested; however, as the logs of borings indicate, the characteristics of the subsurface soils at the site vary considerably, and therefore the Contractor should not assume that the data obtained from the pumping tests made at the locations specified are representative of all conditions that exist at the site. Therefore, it shall be the responsibility of the Contractor to make his or her own evaluation of the relation of the pumping test data to subsurface conditions at other locations at the site.

(c) The subsurface soils at the site consist of a top stratum of clays, silts, and fine sands, with widely varying degrees of arrangement and stratification, with a depth of about 80 to 120 feet. A stratum of rather pervious sand underlies the entire site with a thickness of approximately 220 feet. The top of this deep thick sand stratum varies from about elevation - 20.0 to - 70.0 feet. Logs of three borings (M-1, M-2, and M-3) made 500 feet deep indicate that this sand stratum is underlain by a clay stratum about 120 feet thick at a depth of about 290 to 380 feet. This clay stratum may or may not be continuous. It is underlain by more sand to a depth of about 400 feet.

(d) The Red River flows along and around a portion of the site for the excavation, the deeper parts of the river in the vicinity of the excavation range from approximately elevation 10.0 to -20.0 feet. To what extent the channel of the river provides an open source of seepage into the underlying deep sand formation is not known; the logs of a few borings made in the bed and along the bank of the river are shown in the previously referenced report by _____. It will be the responsibility of the Contractor to make his or her own evaluation of the effect of the Red River on dewatering and control of seepage into the excavation, not otherwise covered by these specifications.

(e) Chemical analyses of sample of groundwater taken from Test Wells A, B, and C on 28 April 1948 gave the following results:

	Well A		Well B	Well C
	137-ft depth	260-ft depth		
<i>Total</i>				
pH	6.8	7.0	7.0	6.9
Chloride (Cl)	115	30	60	110
Suspended Solids (ppm)	52	34	62	37
Volatile Solids (ppm)	8	5.5	7	5
Total Solids (ppm)	520	762	977	1620
Total Dissolved Solids (ppm)	468	728	915	1583
Total Volatile Solids (ppm)	50	65	88	227
Sulfate (ppm)	7	9	539	202
Hardness (CaCO ₃) (ppm)	390	423	694	1066
Magnesium	26	28	54	94

Total	Well A		Well B	Well C
	137-ft depth	260-ft depth		
Manganese	2	2	1	1
Calcium (ppm)	105	95	165	244
Iron (total) (ppm)	8	19	13	9
Hydrogen Sulfide (ppm)	<0.1	<0.1	<0.1	<0.1
Total Alkalinity (CaCO ₃) (ppm)	405	479	567	480
Carbon Dioxide (CO ₂) (ppm)	120	95	120	110

d. Deep-well dewatering system.

(1) **Scope.** The work provided for herein consists of furnishing all labor, material, equipment, and tools to construct, develop, test pump, and disinfect the filter sand, well, and pump for the dewatering wells to be installed around the perimeter of the excavation at the locations shown on the drawings and as specified herein. The work also includes installation of the pumps, diesel engines, gear drives, couplings, discharge pipes, valves, fittings, flow measurement devices, and discharge pipe.

(2) **Design.** The deep-well system specified has been designed to lower the groundwater table in the deep sand stratum beneath the excavation to elevation - 26.0 feet beneath the dam, elevation - 29.0 feet beneath the lock chamber, and elevation -35.0 feet beneath the gate bays for a design Red River stage of elevation of 60.0 feet (estimated maximum river stage for a frequency of 1 in 20 years). The purpose of the deep-well system is to lower the hydrostatic head in this sand stratum so as to prevent seepage into the bottom of the excavation and to prevent any heave of impervious soil strata that overlie the deep sand formation in certain areas of the excavation. It is imperative that there be no heave of the bottom of the excavation during either Phase II or Phase III construction of the lock and dam, If evaluation of the pumping test made at the completion of unwatering the Phase I excavation indicates the need for additional dewatering wells, pumps, engines, discharge piping, and appurtenances, the Government will design the supplemental system and furnish the design to the Contractor for installation. The Contractor will be reimbursed for the cost of installing any supplemental wells, pumps, engines, discharge piping, and appurtenances, when completely installed and ready for operation. The Contractor shall be responsible for designing any features of the well system not specifically covered by these specifications or drawings.

(3) Installation of wells.

(a) **Location of wells.** The dewatering wells shall be installed at the designated locations. Soil conditions in the areas where the wells are to be installed are depicted in a general way by the boring logs made around the excavation. Subsurface conditions and stratification are erratic at this site, and clay, silt, and sand

strata (with or without gravel and cobbles) may be encountered in drilling the holes for the specified wells. Logs and wood debris have also been encountered in making borings and drilling wells at some locations at the site,

(b) **Depth of wells.** The wells shall be installed to a depth so that the top of the specified length of screen (100 feet) is set approximately 5 feet below the top of fine (or coarser) sand as determined at the time of drilling by the C.O.R. The elevation at which the top of the screen shall be set is shown on certain logs of borings along the line of the dewatering wells. The top of fine sand ($D_{10} \geq \pm 0.12$ mm) below which the screen is to be set will probably vary from what is shown on the boring logs. The hole drilled for the wells will be logged by the C.O.R. If buried logs or boulders are encountered which, in the opinion of the C.O.R., render it impractical to advance the drill hole to the design depth, the C.O.R. may adjust the depth in order to utilize the well in the system at the depth actually obtained, or he or she may request the Contractor to abandon the well, plug the hole by backfilling, and construct another well at an adjacent location.

(c) **Drilling.** The dewatering wells shall be drilled by the reverse rotary method to a depth which will permit setting the top of the screen in fine (or coarser) sand as determined at the time of drilling by the C.O.R. The water level in the sump pit and the well shall be maintained a minimum of 8 feet above the groundwater table at all times until the well screen, riser pipe, filter, and backfill have been placed. Drilling of the well shall be carried out so as to prevent any appreciable displacement of materials adjacent to the hole or cause any reduction in the yield of the well. (A temporary surface casing with a *minimum* length of 20 feet shall be set prior to the start of drilling.) The diameter of the hole drilled for the well shall be 28 to 30 inches. The hole shall be advanced using a reverse-rotary drill rig with a (minimum) 5-inch I.D. drill stem. While drilling and installing the well, the drill hole shall be kept full of (natural) drilling fluid up to the ground surface with turbidity of about 3000 parts per million. No bentonite drilling mud shall be used while drilling or installing the well. Silt may be added to the drilling water to attain the desired degree of muddiness (approximately 3000 parts per million) if necessary. If natural turbid water, or with silt added, proves insufficient to keep the hole stable, an approved organic drilling compound such as Johnson's Revert, or equivalent, may be added to the drilling fluid. The Contractor shall dig a sump pit large enough to allow the sand to settle out but small enough so that some silt is kept in suspension. The drilled hole shall be 3 feet deeper than the well screen and riser to be installed in the hole. All drilling fluid shall be removed

from the well filter and the natural pervious information after the well is installed.

(d) Installation of well screen and riser.

Step 1. Assembly. The joints between the screen sections and between the screen and riser pipe shall be welded with stainless steel rod. Particular care should be exercised to avoid damaging the screen and riser. It shall be centered in the well hole or casing and held securely in place during placement of the filter by means of spiders and approved centering guide, tremie holder, or other approved method. Prior to installation of any screen and riser the Contractor shall submit to the Contracting Officer for approval full details of the method, equipment, and devices he proposes to use for centering and holding the screen and riser pipe in the well hole.

Step 2. Installation. The assembled screen and riser pipe shall be placed in the well hole in such a manner as to avoid jarring impacts and to insure that the assembly is not damaged or misaligned.

Step 3. Alignment. Each completed well shall be sufficiently straight and plumb that a cylinder 10 feet in length and 2 inches smaller in diameter than the inside diameter of the well may be lowered for the full depth of the well and withdrawn without binding against the sides of the screen or riser pipe. A variation of 6 to 12 inches will be permitted in the alignment of the screen and riser pipe from a plumb line at the top of the well; however, this will not relieve the Contractor of the responsibility of maintaining adequate clearance for bailing, surging, and pumping required for pumping the wells.

(e) Placement of sand filter (A). After the screen and riser pipe have been placed, the filter sand shall be tremied into the annular space between the well screen or riser pipe and the drilled hole using a 4- or 5-inch-diameter tremie pipe with flush screw joints and at least two slots $\frac{1}{16}$ inch wide and about 6 inches long per linear foot of tremie. The tremie pipe shall be lowered to the bottom of the hole and then filled with filter sand. (If the filter sand has a tendency to segregate, the filter sand shall be kept moist following delivery to the work site in order to minimize segregation.) After the tremie has been filled with filter sand, it shall be slowly raised, keeping the tremie full of filter sand at all times until the filter sand has filled the hole up to within $15 \pm$ feet of the ground surface. The bottom of the tremie pipe shall be kept slightly below the surface of the filter sand in the hole as the tremie is raised.

(f) Development of well. After installation of the well, it shall be developed by surging with a surge block and pumping, as described below, for not less than 30 minutes. (If Revert or equivalent approved organic drilling additive has been used in drilling the hole, a breakdown agent such as Johnson's Fast-Break or equivalent shall be added to the well in accordance

with the manufacturer's recommendations prior to surging.) Development of the well shall be started within 4 to 12 hours after the well has been installed. Surging of the well shall be accomplished with a surge block raised and lowered through the well screen at a speed of 2 to 3 feet per second. The gaskets on the surge block shall be slightly flexible and have a diameter about 1 inch smaller than the inside diameter of the well screen. The amount of material deposited in the bottom of the well shall be determined after each cycle (about 10 to 20 trips per cycle). Surging shall continue until the accumulation of material pulled through the well screen in any one cycle becomes less than 0.2 foot. The well screen shall be bailed clean with a piston-type bailer when the accumulation of material in the bottom of the screen becomes more than 2 to 3 feet at any time during surging; the well shall also be cleaned after surging is completed. After completion of surging, the well shall be pumped with the pump section about 1 foot off the bottom of the well until the discharge is clear and is reasonably free of sand (less than 10 to 20 parts per million sand). Such pumping shall begin within 2 hours after surging and shall continue for not less than 30 minutes. The well shall be pumped so as to achieve a drawdown of not less than 20 feet, or a flow of approximately 1000 gallons per minute, whichever is first. If, at the completion of pumping, the well is producing sand at a rate in excess of 10 to 20 parts per million, it shall be resurged and pumped again. Alternate surging and pumping shall be continued until material entering the well during either surging or pumping is less than the amount specified above, but not for a period longer than 6 hours. Wells which continue to produce an excessive amount of sand or filter material during development shall be abandoned as requested by the C.O.R. except that, if he or she so elects, he or she may request the Contractor to continue to develop the well by an approved method. If, after such further development, a well meets the above stated requirements, it shall be completed, and after successful completion of the required pumping test, the well will be accepted. If, after completion of all surging and pumping, there is more than 0.5 foot of material in the bottom of the well, such material shall be carefully removed with either a piston-type bailer or by pumping. The water resulting from pumping the well shall be discharged outside the work area at locations approved by the C.O.R. Pertinent data regarding installation of the wells will be recorded by the C.O.R. After completion of satisfactory development of a well, the grout seal shall be placed.

(g) Disinfection of drill hole and filter sand.

During the drilling operation, a minimum of 1 pound of calcium hypochlorite shall be added to the drilling fluid every 2 hours. As the filter sand is placed in the

well, calcium hypochlorite shall be added to evenly distribute a minimum of 2 pounds per ton of filter. Upon completion of development of the well and prior to installing the well cover, a minimum of 5 pounds of granular 70 percent calcium hypochlorite shall be dropped in the well and allowed to settle to the bottom.

(h) *Covers.* The top of a well shall be sealed immediately after completion of installation with a watertight seal which shall be kept in place at all times, except during cleaning and pumping operations, until the pump and gear drive are installed.

(i) *Abandoned wells.* Holes for wells abandoned prior to placement of well screen and riser pipe shall be filled with sand and cement grout. Wells abandoned after placement of well screen and riser pipe may be pulled and the remaining hole filled with sand to within 25 feet of the surface. The remaining 25 feet should then be backfilled with an approved cement grout. Bentonite may be added to the grout to improve its pumpability. If the Contractor elects to leave an abandoned well screen and riser in place, it shall be plugged as described above. Wells which are abandoned as a result of alignment or plumbness being outside of these specifications, or wells which produce sand in excess of 5 parts per million after development and pump testing, shall be replaced by the Contractor at no cost to the Government.

(j) *Well records.* The following information regarding the installation of each well will be recorded by the C.O.R. The Contractor shall cooperate and assist the C.O.R. in obtaining the following information: well number, location, top of riser (mean sea level), date and time test started and stopped, depth to water in well before and at end of pumping, elevation of water in well immediately before and at end of pumping, flow in gallons per minute, depth of sand in well before and after completion of pumping, rate of sanding at end of pumping period, depth of sand in well after cleaning, screen length, depth of hole, inside depth of well, depth to sand in well after cleaning, top of well screen (mean sea level), top of filter (mean sea level), bottom of well (mean sea level), top of well, method of surging, material surged into well (last cycle) in feet, total material surged into well in feet, rate of pumping and drawdown, total pumping time, and rate of sand infiltration at end of pumping in parts per million.

(4) *Pumping test on each well.*

(a) Upon completion of installation, surging, and developing pumping, each well shall be subjected to a pumping test. Prior to commencement of the pumping test, and again after completion of the pumping test, the depth of the well shall be measured when the C.O.R. is present by means of an approved flat-bottom sounding device.

(b) The pump shall be capable of pumping at the rate of 1500 gallons per minute, over a period of time sufficient to satisfactorily perform the pumping test specified. An approved means for accurately determining the water level in the well and a calibrated flow meter or orifice of standard design for the purpose of measuring the discharge from the well during the pumping test shall be provided. The Contractor shall furnish and install the necessary discharge line so that the flow from the well can be pumped into an adjacent area approved by the C.O.R. The pumping and sand infiltration test shall be conducted in the presence of the C.O.R., who will record the following test data: well number, location, top of riser (mean sea level), date and time test started and stopped, depth to water in well before and at end of pumping, elevation of water in well immediately before and at the end of pumping, rate of sanding at end of pumping period, and depth of sand in well after cleaning.

(c) The Contractor shall test each well by pumping continuously for a minimum of 2 hours. Pumping shall be at a constant rate sufficient to produce either a **drawdown** of 20 feet, or a constant rate of flow of 1500 gallons per minute, whichever occurs first. The computed rate of sanding shall take into consideration the pumping rate, the rate of sand emerging from the pump, and the amount of emptying or buildup of sand in the bottom of the well during the (sand) testing period as determined accurately with a flat-bottom sanding device. No test pumping of a well will be permitted concurrently with drilling, surging, or pumping of any other well within 300 feet thereof.

(d) In the event that sand or other materials infiltrate into the well during the pumping test, the following procedure will be followed: If the rate of sand infiltration during the last 15 minutes of the pumping test is more than 5 parts per million, the well shall be resurged by manipulation of the test pump for 15 minutes after which the test pumping shall be resumed and continued at the rate specified above until the sand infiltration rate is reduced to less than 5 parts per million. If at the end of 6 hours of pumping the rate of infiltration of sand is more than 5 parts per million, the well shall be abandoned unless the C.O.R. requests the Contractor to continue to test pump and perform such other approved remedial work as he considers desirable. If, after such additional test pumping and other remedial measures, the sand infiltration rate of the well is reduced to less than 5 parts per million, the well will be accepted. Upon completion of the pumping test, any sand or filter material in the bottom of the well shall be removed by pumping or with a piston-type bailer.

(5) *Installation of pump and chlorination.* Each dewatering well shall be chemically treated with calcium hypochlorite (chlorine) within 24 hours after the

test pump is removed, A solution of calcium hypochlorite (HTH) shall be mixed with water in a tank (minimum capacity of 3000 gallons to obtain a 1000-parts-per-million chlorine solution). (Fifteen pounds of (dry) 70 percent calcium hypochlorite will make 1000 gallons of 1000-parts-per-million chlorine solution.) A minimum of 30 gallons per foot of screen shall be pumped into the well through a hose extended to the bottom of the well. As the chlorine solution is pumped into the well, the hose shall be withdrawn at a rate which will insure that the chlorine solution is added uniformly from the bottom of the well to a point 10 feet above the top of the well screen. The chlorine solution in the well shall then be surged with a loose fitting surge block for 1 hour. The permanent dewatering pump shall then be immediately installed, and the well pumped until the chlorine is essentially removed. (If it is not possible to promptly install, the permanent pump, the chlorine should be allowed to set 3 or 4 hours, and the well pumped by some means to remove the chlorine.) If the permanent pump is subsequently installed, the well and pump shall be rechlorinated as described above except the surging shall be omitted.

(6) *Equipment and materials.*

(a) *Quality.* All installed equipment and materials shall be new except the discharge header system which may be either new or "like new" used pipe.

(b) *Power units.* Each of the 64 deep wells shall be equipped with a direct drive diesel power unit. The engines shall be certified to produce a minimum of 115 continuous net horsepower at 1800 revolutions per minute to the gear drive and shall be a Caterpillar Model 3304 T, Detroit Diesel Model 4-71N, or equivalent as approved by the Contracting Officer. The unit shall be skid mounted with clutch power takeoff, have hood and side panels, fan shroud, muffler, high temperature and low oil pressure shutdown, battery, and fuel supply. Any additional item to make the unit function on a continuous 24-hour-per-day operation shall also be included. Engines shall be operated within the revolution-per-minute limits of the manufacturer's recommendations. The unit shall be leveled and mounted on a 6-inch-thick concrete base. Prior to operation, each unit shall be started and serviced by a manufacturer's factory trained representative, or equally qualified mechanic. The power units shall be operated and maintained in accordance with the manufacturer's recommendations. Each power unit shall have an independent fuel tank with a capacity of at least 500 gallons. Fuel lines shall be provided with an approved screen or filter and shall be attached to the tank so that rain or contaminants may not enter the tank. The tank shall be properly vented and equipped with a drain plus and filler port. All fuel tanks shall be new and cleaned prior to being placed in service. At the commencement of pumping, the Con-

tractor shall have at the jobsite five new complete diesel power units. During the pumping period, the Contractor shall have a minimum of five (new or re-manufactured) diesel power units, complete with all components, available as standby. The Contractor shall also keep in stock on the jobsite other miscellaneous spare parts essential to routine maintenance of the engines, pumps, gear heads, flexible couplings, valves, etc., as considered appropriate and approved by the C.O.R.

(c) *Pumps.* Deep-well turbine pumps, similar or equivalent to such pumps manufactured by Layne-Bowler, Fairbanks-Morse, Johnston, Jacuzzi, or other qualified pump manufacturer, shall be designed for pumping clear water at a rated capacity of 1500 gallons per minute at a total dynamic head of 200 feet and pump speed of 1800 revolutions per minute with a bowl efficiency of about 80 percent. The pump bowl assembly shall be of close-grained cast iron porcelain enamel-coated inside and fitted with replaceable bronze wear rings and sleeve-type shaft bushings, Impellers shall be cast iron or bronze and designed for nonoverloading. The bowl shaft shall be high-chrome stainless steel of sufficient diameter to transmit the pump horsepower with a liberal safety factor and rigidly support the impellers between the bowl or case bearings. The pump column assembly shall consist of thirteen 10-foot sections of 10-inch steel threaded pipe with line pipe couplings. Bronze spiders with rubber bearings shall align the shaft bearings in each section. Line shafts shall be of Grade 1045 (ASTM A 108) steel ground and polished with Type 304 (ASTM A 743) stainless steel sleeves to act as a journal for each rubber line shaft bearing. A 10-foot section of 10-inch threaded suction pipe shall be screwed into the bottom of the pump bowl. The discharge head shall be provided for mounting the gear drive and supporting the pump columns, bowls, and suction pipe. The design shall permit the drive shaft to be coupled about the stuffing box to facilitate easy removal and replacement of the driver. The stuffing box shall be of the deep bore type with a minimum of six rings of packing and a steel case. The packing gland shall be the bronze split-type and secured with stainless steel studs and silicone bronze nuts.

(d) *Gear drive and flexible coupling.* A right angle gear drive with a gear ratio of 1:1 shall be installed on each pump. Horsepower rating shall be based on American Gear Manufacturers Association standards for spiral bevel gears. Ball and roller bearings shall have a capacity to carry the horsepower and thrust loads for a minimum of 20,000 hours. The housing shall be a rigid semisteel casting properly proportioned to insure correct alignment of the gears under full load. Case-hardened spiral bevel gears shall be held in position by antifriction bearings selected to

convey the loads over a 4-year period of operation. A large stream of oil shall be pumped to the gears and bearings by a pump located in the base of the housing. The vertical shaft shall be hollow to allow for easy adjustment of the pump shaft. Provision shall be made for circulating water through a copper coil installed inside the case. A flexible drive shaft, Watson-Spicer WL-48, or equal, shall be provided with each gear drive. The shaft shall be a minimum of 36 inches long and provided with drive flanges to fit the engine and gear drive. A protective cover made of galvanized sheet metal or expanded metal shall be permanently attached between the engine and gear drive to shield the drive shaft.

(e) *Standby equipment.* At the commencement of pumping, the Contractor shall provide and have in stock at the jobsite three new complete standby turbine pumps. During the pumping period, the Contractor shall continue to have a minimum of three (new of rebuilt) pumps available as standby units, which shall be complete with column, shafting, pump head, gear drive, and flexible coupling.

(f) A minimum of 20 feet of each size of header pipe and two of each size of Dresser couplings (or equivalent) shall be on site for emergency repair if necessary. Twelve S-inch flanged nipples shall also be kept on site for adding S-inch rubber or plastic cloth discharge hose for emergency pumping of the deep wells in event of discharge pipe failure. Sixty-five hundred feet of S-inch rubber or plastic cloth hose shall be kept on site for pumping of individual wells.

(g) *Operation and repair or replacement.* The pumps shall be operated so that the water level in the wells is not lowered below the pump bowl. The pumps and engines shall remain in operable condition at all times with no more than two wells or pumps being inoperative at any one time. No two adjacent wells or pumps shall be inoperative at the same time. The Contractor shall take immediate steps to repair or replace any well, pump, gear drive, or engine which is inoperative. Should the efficiency of a dewatering well show any significant reduction from its initial efficiency, the Contractor may, at the direction of the C.O.R., be required to redevelop and/or chemically treat the well as directed by the Contracting Officer, the cost of which will be paid for under paragraph 3 (Changes) of the General Provisions of the Contract.

(h) *Riser pipe.* The riser pipe for the wells shall be 16-inch diameter, 0.250-inch or thicker wall, steel pipe.

(i) *Well screen.* The well screen shall be Johnson, Houston, or equal, wire-wrap type 304 stainless steel screen with a minimum inner diameter of 15 inches (16-inch pipe size) with a nominal length of 100 feet. The width of the slots will be 0.040 inch. The (keystone or trapezoidally shaped) screen wire shall be

wrapped and welded on 0.177-inch round rod. The well screen shall be furnished in lengths of 10 or 20 feet. One section of screen for each well will be provided with a stainless steel bottom plate.

(j) *Filter sand.* The filter around the well screen and riser pipe shall be an approved washed (clean) sand or crushed stone composed of hard, durable, uniformly graded particles free from any inherent coating. The filter sand shall contain no detrimental quantities of vegetable matter, nor soft friable, thin, or elongated particles, and shall meet the following gradation requirements:

U.S. Standard Sieve No.	Percent by weight passing
1/4	100
4	95-100
6	85-100
10	55-85
14	28-65
16	20-55
20	10-32
30	0-18
40	0-10

If blending of two or more sands is required to obtain the specified gradation, the blending shall be accomplished so as to achieve a uniform mix approved by the C.O.R.

(k) *Discharge system.* The discharge piping is for the purpose of conveying the water from the dewatering wells to the flotation channel on the south side of the cofferdam area. Under no conditions shall the Contractor discharge water from the dewatering systems outside of the cofferdam dike other than at the specified location. The header pipe installed at the specified locations shall be standard structural grade pipe with the following minimum wall thicknesses:

Pipe diameter, inches	Minimum wall thickness, inches
12	0.22
18	0.25
24	0.25
30	0.25
36	0.28
42	0.28

The diameter of the pipe will vary from 12 to 42 inches. Connections may be made either by welding or by Dresser couplings with tie rods. The pipe shall be laid straight, on approved blocking, in a workmanlike manner. Where crossing a road or ramp, the pipe shall be laid in an open separate culvert. The discharge pipe through the cofferdam dike shall have welded joints and be provided with "seepage" fins. A 42-inch Calco, or equivalent, flap gate shall be installed on the end of each discharge pipe. The discharge line from the well to the header shall be 8 inches in diameter and include a gate valve that can be locked or will remain in a fixed position while partially closed, a positive check valve and a pitometer cock for insertion of a pitot tube to

measure well flow. Certain wells shall be provided with a tee and blind flange for connection of an 8-inch discharge hose in event of damage or failure of the main discharge header pipe. The Contractor shall construct splash facilities for discharge water at the dredge channel. The Contractor shall maintain the discharge splash facilities so as to prevent erosion or damage to the channel slopes and to modify such if found necessary.

(7) *Pumping test on the dewatering systems.*

(a) After the deep-well dewatering system is completely installed, a pumping test shall be made on the entire system by pumping all the wells at the same time at a constant pump speed or flow rate for each well, the pumping rate to be determined by the C.O.R. prior to the test. If the selected pumping rate lowers the water level in any well below the pump bowl, the engine speed shall be reduced or the discharge valve partially closed so that the water level in that well is not lowered below the pump bowl.

(b) This test, the first, shall be made prior to starting to unwater the Phase I excavation. The wells shall be pumped continuously for at least 24 hours and for not more than 48 hours as required by the C.O.R. The Contractor shall have previously installed the M piezometers around the perimeter of the excavation, the R, S, and T piezometers on lines out from the excavation, and provision has been made to measure the flow as shown on the drawings and specified herein. The C.O.R. will keep a systematic record of discharge throughout the test period and will record the water level in the piezometers and wells immediately prior to commencing the test and at certain intervals thereafter. The pumping test shall be conducted under the general direction of the C.O.R. with the Contractor being responsible for actual operation of the system.

(c) If an analysis of the pumping data by the Government indicates probable adequacy of the system, the Contractor may start unwatering the Phase I excavation while continuing to operate the dewatering well system so as to maintain the groundwater table in the deep sand formation, as indicated by the M piezometers installed around the top of the excavation, 3 to 5 feet or more below the water level in the excavation.

(d) After the Phase I excavation is unwatered, all wells shall be pumped at a constant rate to be prescribed by the C.O.R. for at least 48 hours and not more than 120 hours, as determined by the C.O.R., as a further check on the adequacy of the dewatering well system with the excavation unwatered. As during the first test, the rate of flow from each well and the entire system shall be measured throughout the test period, and the water level in the M, R, S, and T piezometers and in the dewatering wells will be measured and recorded at certain intervals during the test. The ade-

quacy of the deep-well system will be evaluated on the basis of the pumping test made upon completion of unwatering of the excavation, for a Red River stage of elevation 60 feet. If at the end of the pumping test, an analysis of the data by the Contracting Officer or his C.O.R. indicates the system to be adequate, it will be approved; if the dewatering well system appears to be inadequate, for a design Red River stage of elevation 60 feet, the Contracting Officer will direct the Contractor to install additional dewatering wells, pumps, engines, and necessary pertinent piping and fittings for which he will be compensated as an extra.

(e) If it appears, while unwatering the Phase I excavation and the second pumping tests on the deep-well system, that the groundwater table in the top stratum has not been adequately lowered by the specified jet-eductors wells and pumping the deep-well system, the Contractor shall install whatever additional jet-educator wells, pumps, and piping considered necessary by the C.O.R. for which he will be compensated as an extra.

e. *Jet-educator well system.*

(1) *Scope.* The work provided for herein consists of furnishing all labor, material, equipment, and tools to install, develop, and test pump the jet-educator wells to be installed around the perimeter of the excavation at the locations shown on the drawings and as specified herein.

(2) *Design.* The jet-educator wells to be installed on the upper berm around the excavation at elevation 28 to 34 feet are to intercept the seepage from silt, sandy silt, silty sand, and sand strata which are penetrated in some areas by the outer excavation slopes. The purpose of the jet-educator wells is to lower the groundwater table below the slopes of the main excavation and to prevent any detrimental raveling or instability of the slopes caused by seepage. The jet-educator wells shown on the contract drawings and as specified herein have been designed to lower the groundwater table in the upper silts and sands to within about 2 or 3 feet of the contact with any underlying impervious stratum where shown on the drawing. However, other reaches of the outer excavated slopes than shown on the drawings may require dewatering or drainage. If observations indicate the need for dewatering other reaches of the outer slopes, the Government will design the supplemental jet-educator wells and system and furnish the design to the Contractor for installation. The Contractor will be reimbursed for the cost of any supplemental wells, jet-educator pumps, and piping when completely installed and ready for operation, as an extra. The Contractor shall be fully responsible for controlling the groundwater table and seepage from and below the main excavated slopes as specified herein, and for proper installation, operation, maintenance of the specified jet-educator wells, and any sup-

plemental dewatering measures installed for controlling the groundwater within the excavation.

(3) *Installation of jet-educator wells.*

(a) *Location and depth of wells.* The jet-educator wells shall be installed at the designated locations. Soil conditions where the jet-educator wells are to be installed are depicted in a general way by the logs of borings made around the excavation. The wells should extend about 2 feet below the bottom of the pervious strata being drained. The required depth of the wells may vary considerably from those indicated on the drawings.

(b) *Drilling and jetting.* The jet-educator wells shall be installed in the following manner:

Step 1. Predrill a 10- or 11-inch hole 2 feet below the silt or silty sand stratum to be drained. Hydraulic rotary, or auger, methods of drilling may be used. No drilling muds or additives, other than clear water, shall be used in drilling the hole for the well. The hole shall be kept full of water during the predrilling, and withdrawal of the auger, so as to minimize caving.

Step 2. After predrilling the hole to grade, it shall be washed out by driving and jetting (with clear water) a 12-inch "sanding casing" with a hole puncher to the bottom of the predrilled hole.

Step 3. After the "sanding casing" is driven and jetted to the required depth, it shall be washed clean by jetting with clear water. The jet pump, pipe, and hose shall be of sufficient capacity to produce an upward velocity inside the casing to efficiently remove all material in the casing, so that the well screen and riser can be set to grade. The "sanding casing" shall be kept filled with water until the well screen and filter sand have been placed so as to prevent any "blow in" of the bottom of the hole.

(c) *Installation of well screen and filter sand.* After the sanding casing has been cleaned by jetting and the clear depth in the casing checked by sounding with an approved device, the well screen shall be lowered to the bottom of the casing. Particular care shall be exercised in handling and placing the screen so as not to damage it. Complete assembly of the screen and riser pipe on the ground surface will not be permitted. Two or three connections shall be made to the assembly as it is placed in the casing. Approved centralizers shall be furnished and attached to the screen at intervals not greater than 20 feet. The design and attachment of the centralizers to the well screen shall be submitted to the C.O.R. for approval. The top of the riser pipe shall be securely covered or capped to prevent the filter sand from falling into the well. The method of placement shall assure a fairly rapid, continuous, uniform rate of placement of filter sand, which will evenly distribute the filter sand around the screen. The rate of placing the filter sand shall not cause

bridging of the sand in the "sanding" casing. As the filter material is placed in the well screen, 70 percent granular calcium hypochlorite shall be added to evenly distribute a minimum of 2 pounds per ton of filter. The method of placement shall be approved by the C.O.R.

(d) *Development of jet-educator wells.* Within 12 hours after installation of each well, it shall be developed by means of air-lifting. A 2-inch inner diameter air line shall be lowered in the well to within 1 foot of the bottom of the well and sufficient air be pumped through the air line to cause the well to flow. For low-yielding wells, it may be necessary to add clear water to help develop the well and remove any sand that may have entered the screen. Air-lifting shall continue until all sand or filter material is removed from inside the screen and water from the well flows clear. Each well shall be developed for a minimum of 20 minutes.

(e) *Chlorination of well.* Upon completion of installation of the well and prior to installing a cap on the top of the riser, a minimum of 3 pounds of 70 percent granular calcium hypochlorite shall be dropped into the well,

(f) *Well top.* The 4-inch riser shall extend 6 inches above the ground surface and shall be sealed around the riser pipe for the jet-educator pump. The well number shall be painted on the top of the riser pipe.

(g) *Riser pipe.* The 4-inch riser pipe for the wells shall be 15 feet in length. The filter sand shall extend to within 8 to 10 feet of the berm surface; the space around the riser pipe from the filter to the berm surface shall be grouted with an approved bentonite-cement grout.

(h) *Well records.* A report showing depth, elevations, date of installation, approximate rate of flow during development, and any other data concerning installation of each well will be completed by the C.O.R. The water level in the well shall be recorded at the time of installation. The Contractor shall assist in obtaining the installation data. If the jet-educators or pumps appear to be losing their efficiency with the passage of time, the Contractor may be required to redevelop and/or chemically treat the wells as directed by the Contracting Officer, the cost of which will be paid for under paragraph 3 (Changes) of the General Provisions of the Contract.

(4) *Materials.*

(a) *Riser pipe.* The riser pipe and the 2-foot blank pipe on the bottom of the screen shall be 4-inch diameter, flush-joint Schedule 80, type 2110 PVC pipe.

(b) *Screen.* The screen shall be 4-inch, Schedule 80, type 2110 PVC screen. The screen shall be slotted with .025-inch slots in sufficient numbers to give a minimum area of opening of 5 percent. The screen section of the well shall extend from the top of any semi-

pervious strata as shown by the boring logs, or as encountered, to the depth specified.

(c) *Filter sand.* Filter sand around the well screen shall be washed (clean) uniform sand or crushed stone composed of hard, tough, and durable particles free from any adherent coating. The filter sand shall contain no detrimental quantities of vegetable matter, nor soft, friable, thin, or elongated particles, and shall meet the following gradation requirements:

<i>Filter Sand B</i>	
<i>U.S. Standard Sieve No.</i>	<i>Percent by weight passing</i>
8	95-100
10	92-100
14	75-100
16	65-95
20	30-77
30	10-30
40	1-13
50	0-5

(5) *Jet-educator pumps and header pipe.* The jet-educator pumps shall have the specified pumping capacities. The pressure pumps for operating the jet-educator pumps shall have a diesel engine with a horsepower of at least 110 and a capacity of 1800 gallons per minute at a total dynamic head of at least 150 feet on a continuous basis. The standby pumps shall have the same horsepower and capacity. The pressure header pipe shall be Schedule 40; the return header pipe shall have a minimum wall thickness of 0.20 inch. The sump pumps for the jet-educator systems shall be an electric, automatic priming type, with a capacity of pumping 600 gallons per minute at TDH = 50 feet.

f. Surface water control

(1) The Contractor shall be fully responsible for designing all features of the system for unwatering the excavation and controlling surface water that may fall into the excavation. The sump pumping system shall be designed with sufficient storage and pumping capacity to prevent flooding the bottom of the excavation for the dam for at least a 1 in lo-year rainfall intensity, assuming 100 percent runoff, for the following periods:

<i>Period</i>	<i>Rainfall</i>	
	<i>Intensity, inch/hour</i>	<i>Amount, inches</i>
30 minutes	4.5	2.25
1 hour	3.0	3.00
2 hours	2.0	4.00

In any event, the Contractor shall be responsible for controlling whatever surface runoff occurs, regardless of rainfall intensity, so as to protect the area for **pile driving** and testing from flooding.

(2) The Contractor shall submit for approval within 15 calendar days, after he or she has received a Notice to Proceed, drawings, design data, and characteristics of the equipment he proposes to utilize in unwatering and controlling surface water. The data

and drawings to be submitted shall include, but not necessarily be limited to:

(a) Location and size of sumps, pumps, and dikes.

(b) Height and elevation of dike around excavation.

(c) Characteristics of sump pumps and horsepower of engines.

(d) Location and size of discharge piping. (Surface water shall not be pumped into the discharge header for the dewatering (well) system.)

g. Dewatering perched groundwater in lower part or bottom of excavation. The Contractor shall be fully responsible for design and installation of any supplemental dewatering facilities that may be required to control any seepage or groundwater in the bottom or lower part of the excavation in order to assure a stable subbase and permit work to be conducted in the "dry." These supplemental measures may include well-points, sand drains, French drains, and appropriate pumps, piping, and appurtenances as necessary and approved by the C.O.R. subject to satisfactory performance of the facility installed. Pay for any such supplemental dewatering, if required, for the lower or bottom part of the excavation should be included in the price for excavation. There will be no charges or claims for extra compensation or time extension for any supplemental dewatering performed in the bottom or lower part of the excavation.

h. Monitoring dewatering systems.

(1) *General.* Continuous control of seepage into and artesian pressure beneath the excavation is essential for driving the test and foundation piles for the dam, and subsequent construction of the lock and dam. It is therefore imperative that the dewatering systems have adequate capacity to control the groundwater beneath the slopes and the excavation as specified at all times. In order to check the adequacy and performance of the dewatering systems, the Government will make the following measurements and evaluate the data:

(a) Measure the groundwater table beneath the bottom of the excavation by means of M, R, S, and T piezometers installed in the deep sand aquifer that underlies the site at specified locations.

(b) Measure the groundwater table at selected locations where the excavation penetrates silts and silty sands in the top stratum overlying the deep sand formation by means of N piezometers installed at the locations.

(c) Measure the flow from individual wells and from the complete dewatering system.

(d) Measure the water level in the dewatering wells.

(e) Measure sand in the flow from dewatering wells.

(f) Measure the head loss through the filter and well screen for selected wells.

(g) Read river stages.

The piezometers for monitoring the groundwater table beneath the slopes and bottom of the excavation shall be installed by the Contractor. The pitometers for measuring the flow from individual wells and from the complete system will be furnished by the Government. Copies of the data obtained by the Government will be promptly furnished to the Contractor. The Contractor will furnish and install the pitometer inserts. Operation and maintenance of the dewatering systems, any supplemental groundwater control facilities if required, and surface water control facilities shall be supervised by someone trained and with at least 5 years of actual experience in managing large dewatering systems and operating pumps and engines.

(2) *Piezometers.*

(a) *Locations.* The M, R, S, and T piezometers shall be installed to measure the groundwater table in the deep sand formation beneath the excavation, between the dewatering wells, and on three lines out from the excavation at the approximate locations shown on the drawings. The N piezometers shall be installed to measure the groundwater table in semipervious strata in the bottom of the excavation and midway between jet-educator wells at the approximate locations. The Contractor shall stake the piezometers at designated locations. The tips of M, R, S, and T piezometers for measuring the groundwater table in the deep sand formation shall be set in clean sand at elevation -80.0 feet or below as necessary; the tips of the N piezometers for measuring the groundwater table in semipervious strata in the top stratum shall be set at the bottom of the semipervious strata.

(b) *Piezometer materials.* The N piezometers shall consist of a 1.50-inch I.D. (Schedule 80) PVC screen with 0.025-inch slots connected to a 1.50-inch I.D. (Schedule 80) PVC riser pipe. The screens shall be 10 feet long. The joints of the screen and riser shall be flush (inside and outside) and shall be glued together with PVC pipe cement. The filter sand (B) shall meet the specifications set forth for jet-educator wells. Depending upon the method of installation, the riser and screens for the M, R, S, and T piezometers shall be as specified above, or 1.5-inch galvanized iron riser pipe connected to a 1.5- by 30-inch self-jetting wellpoint with a 30- to 40-mesh stainless steel screen.

(c) *Installation of piezometers.* Holes for piezometers may be advanced by either: using an S-inch O.D. continuous flight auger with a 3 $\frac{3}{8}$ -inch I.D. hollow stem with the hollow stem plugged at the bottom with a removable plug; augering and more or less simultaneous installation of a 6-inch casing; or using a rotary wash drilling procedure (6-inch diameter) and an organic drilling fluid, such as Revert, if necessary,

to keep the drilled hole open. The tip of the piezometers shall be installed at approximate depths or elevations as approved by the C.O.R.; piezometers shall also be installed as instructed. The hole for a piezometer shall be kept filled with water or an approved organic drilling fluid at all times. Bentonitic drilling mud shall not be used. Any auger used in advancing the hole shall be withdrawn slowly from the hole so as to minimize any suction effect caused by withdrawing the auger. (Hollow-stem augers shall be filled with drilling fluid before pulling the plug in the bottom of the auger.) Drilling and installation procedures shall be as specified below and shall be in accordance with accepted practice and to the satisfaction of the C.O.R.

Method 1. Hollow-stem auger. After advancing the hole for the piezometer to grade (1 to 2 feet below the piezometer tip), or after taking the last sample in a hole to receive a piezometer, the hollow-stem auger shall be flushed clean with water and the plug reinserted at the bottom of the auger. The auger shall then be slowly raised to the elevation that the piezometer tip is to be installed. At this elevation the hollow stem shall be filled with clean water and the plug removed. Water shall be added to keep the stem full of water during withdrawal of the plug. The hole shall then be sounded to determine whether or not the hollow stem is open to the bottom of the auger. If material has entered the hollow stem of the auger, the hollow stem shall be cleaned by flushing with clear water, or clean Revert drilling fluid, if necessary, to stabilize the bottom of the hole, through a bit designed to deflect the flow of water upward, until the discharge is free of soil particles. The piezometer screen and riser shall then be lowered to the proper depth inside the hollow stem and the filter sand placed. (A wire spider of design approved by the C.O.R. shall be attached to the bottom of the piezometer screen so as to center the piezometer screen in the hole in which it is to be placed. Use two crossed wires just above the plug in the tip.) Filter sand shall be poured down the hollow stem around the riser at a rate (determined in the field) that will ensure continuous filter sand flow down the hollow stem around the riser and piezometer, and will keep the 8-inch hole below the auger filled with filter sand as the auger is withdrawn. Withdrawal of the auger and filling the space around the piezometer tip and riser with filter sand shall continue until the hole is filled to a point about 5 feet above the top of the piezometer screen. Above this elevation, the space around the riser pipe may be filled with any clean, uniform sand with less than 5 percent passing a No. 100 U.S. Standard sieve up to within 20 feet of the ground or excavated surface. An impervious grout seal shall be placed around the top 20 feet of the ground or excavated surface. An impervious grout seal shall be placed around the top 20 feet of the hole for the M, R, S, and T pie-

zometers, and 5 feet for the N piezometers.

Method 2. Casing. The hole for a piezometer may be formed by setting a 6-inch casing to an elevation 1 to 2 feet deeper than the elevation of the piezometer tip. The casing may be set by a combination of rotary drilling and driving the casing. The casing shall be kept filled with water, or organic drilling fluid if necessary, to keep the bottom of the hole from ‘blowing.’ After the casing has been set to grade, it shall be flushed with water or (clean) drilling fluid until clear of any sand. The piezometer tip and riser pipe shall then be installed and the filter sand poured in around the riser at a rate (to be determined in the field) which will insure a continuous flow of filter sand down the casing that will keep the hole around the riser pipe and below the casing filled with filter sand as the casing is withdrawn without ‘sand-locking’ the casing and riser pipe. (Placement of the filter sand and withdrawal of the casing may be accomplished in steps as long as the top of the filter sand is maintained above the bottom of the casing but not so much as to ‘sand-lock’ the riser pipe and casing.) Filling the space around the piezometer tip and riser with filter sand shall continue until the hole is filled to a point about 5 feet above the top of the piezometer screen. Above this elevation, the space around the riser pipe may be filled with any clean, uniform sand and the hole grouted as specified in Method 1 above.

Method 3. Rotary. The hole for a piezometer may be advanced by the hydraulic rotary method using water or an organic drilling fluid. The hole shall have a minimum diameter of 6 inches. After the hole has been advanced to a depth of 1 or 2 feet below the piezometer tip elevation, it shall be flushed with clear water or clean drilling fluid, and the piezometer, filter sand, sand backfill, and grout placed as specified in Method 2 above, except there will be no casing to pull.

Method 4. Self-jetting. The M, R, S, and T piezometers may be drilled to within 4 feet of planned total depth, then clean water used to advance the self-jetting wellpoint to the design grade without the use of filter sand around the wellpoint. The seal and backfill for the piezometers shall consist of a pumpable cement-bentonite grout, with a ratio of 1 gallon of bentonite per bag of cement, or equivalent cement grout approved by the C.O.R. (Only enough water shall be added to make the grout pumpable.) The tops of the risers shall be cut off 36 inches above the ground surface. The upper part of the piezometer shall be protected by installing a 6-inch I.D. PVC or corrugated metal pipe around the riser cemented in to a depth of 3 feet below the ground surface. The number of the piezometer shall be marked with 3-inch-high black letters on the pipe guard around the riser pipe.

Method 5. Sampling. Split-barrel samples shall be obtained at 5-foot intervals and at every strata change

for the N piezometers. Samples shall be obtained using a 1 3/8-inch (minimum) I.D. split-barrel or 3-inch Shelby tube sampler by driving or pushing. The length of drive or push shall not be less than 3 inches. If there is insufficient sample recovery to identify the soil properly, another sample shall be obtained immediately below the missed sample. If desired, the sampler may be advanced using driving jars on a wireline.

(d) *Development and testing.* After each piezometer is installed, it shall be promptly flushed with clean water, developed, and pumped to determine if it is functioning properly. (If an organic drilling fluid has been used, Johnson’s Fast Break, or equivalent, shall be added in accordance with the manufacturer’s recommendations to break down the drilling fluid,) A 10-foot minimum positive head shall be maintained in the piezometer following addition of the Fast Break. After at least 30 minutes has elapsed, the piezometer shall be flushed with clear water and pumped. The piezometer may be pumped with either a suction pump or by means of compressed air. The approximate rate of pumping during development shall be measured. Piezometers installed in the deep sand formation will be considered acceptable if they will pump at a rate of 2 to 5 gallons per minute or more. Piezometers installed in the semipervious strata within the top strata will be considered acceptable if they will pump at a rate of at least 0.5 gallon per minute, or when the piezometer is filled with water, the water level falls approximately half the distance of the groundwater table in a time less than the time given below for various types of soil:

Type of soil in which piezometer screen is set	Period of observation minutes	Approximate time of 50 percent fall minutes
Sandy silt (> 50% silt)	30	30
Silty sand (< 50% silt, > 12% silt)	10	5
Fine sand (<12% silt)	5	1

If the piezometer does not function properly, it shall be developed by a combination of air surging and pumping with air as necessary to make it perform properly. If the piezometer still will not perform properly, it shall be reinstalled at a nearby location selected by the C.O.R.

(e) *Monitoring groundwater table.* The Contractor shall read all M and N piezometers at least once a week, selected piezometers at least twice a week, some of the piezometers in the deep sand formation daily, and the water level in the dewatering and the jet-educator wells at least once a week for his or her information and use in operation of the dewatering systems and control of groundwater as specified. The Contractor shall record what deep well and jet-educator wells are being pumped when he takes his piezometer or water level readings. The C.O.R. will also read the M

and N piezometers on a schedule similar to the above for his own check and evaluation purposes.

(f) *Records*, The Contractor shall furnish copies of all piezometer and water level readings to the C.O.R. within 24 hours of being taken. Copies of piezometer, water level, and flow measurements made by the C.O.R. will be furnished to the Contractor within 24 hours.

(3) *Dewatering system flow.*

(a) *Flow measurements.* The flow from individual dewatering wells will be measured by means of a pitometer installed in the discharge pipe from the well. As a check on the pitometer measurements and on the performance of the well pump, the rate of flow being pumped will also be estimated from the pump characteristic curve, engine speed, static lift of the water, and the pressure in the discharge pipe at the top of the well. Flow from the entire dewatering system will also be measured by means of a pitometer. All flow measurements will be made by the C.O.R. assisted by the Contractor's "dewatering" engineer.

(b) *Frequency of measurement.* The total flow from the dewatering system shall be measured once or twice a week and the flow from individual wells weekly or biweekly, as appears appropriate.

(c) *Records.* All flow measurements will be recorded by the C.O.R. and a copy of the data furnished to the Contractor within 24 hours. The C.O.R. will be responsible for reading the river gage and recording the data; a copy of the river gage reading will be furnished to the Contractor each day.

(4) *Sanding.* The flow from each dewatering well will be monitored for sanding. The rate of sanding will be determined by taking a measured amount of water being pumped from each well and the sand content determined. The maximum rate of sanding acceptable will be 5 parts per million. The rate of sanding will be checked once a week by the C.O.R. and the data recorded. A copy of the data will be furnished to the Contractor within 24 hours.

i. *Operation and maintenance of dewatering and surface water control systems.*

(1) *Supervision.* Supervisory personnel shall be present onsite during normal working hours and shall be available on call 24 hours a day, 7 days per week, including holidays.

(2) *Operating personnel.* Sufficient personnel skilled in the operation, maintenance, and replacement of the dewatering and surface water control systems, components, and equipment shall be onsite 24 hours a day, 7 days per week, including holidays, at all times when the systems are in operation.

(3) *Well pumping restriction.* The pumping rate of any dewatering (deep) well shall be adjusted, if necessary, by adjustment of engine speed or valving so that the water level in no well is lowered below the pump

bowl. With approval of the C.O.R., the pump bowl may be lowered. In order to maintain maximum well efficiency, the deep-well system shall be operated by pumping whatever number of wells are required to achieve the specified water level lowering in the deep sand formation without pumping any well more than 1200 gallons per minute except in an emergency or if required to achieve the specified water level lowering.

(4) *Responsibility.* Dewatering the excavation includes the control of seepage and artesian pressure in the deep sand stratum underlying the site and the control of seepage from the upper silts and silty sand for the duration of this contract. Included are the operation and maintenance of the deep-well, jet-eductor well, and surface water control systems.

(5) *Repair and replacement.* The specified number of wells and pumps shall be available for use at all times. All damaged or malfunctioning wells or well components shall be repaired or renewed as expeditiously as possible while continuing to maintain the required water levels. The Contractor shall be responsible for all replacement equipment and the repair and maintenance of all system components so as to maintain the system fully operational. Replacement equipment and materials shall conform to the requirements of these specifications.

(6) *Maintenance criteria.* The Contractor shall maintain a regularly scheduled maintenance program which shall conform with the equipment manufacturer's recommendations and include all other work necessary to maintain all components fully operational. The maintenance program shall include, but not be limited to, checking the flow rate and water elevation in each well. All data and records shall be submitted to the C.O.R. at the completion of this contract. The Contractor shall also maintain any nonoperating pumps and engines. Maintenance shall include, but not be limited to, starting each nonoperating pump and engine on a weekly basis and operating the pump for a minimum of 15 minutes. All pumps, both operating and nonoperating, shall be tested for wear, independently, on a monthly basis. The Contractor shall conduct a shutoff head test and a test to verify that the pump is capable of operating at its rated head capacity. The Contractor shall renew all pumps having a test result less than 75 percent of the manufacturer's rated shutoff head or rated capacity. The maintenance tests shall be conducted under the supervision of the Contractor Quality Control representative and under the observation of the C.O.R.

j. *Damages.* The Contractor shall be responsible and shall repair without cost to the Government, any work in place, another contractor's equipment, and any damage to the excavation, including damage to the bottom due to heave that may result from his negligence, improper operation and/or maintenance of the

dewatering system, and any **mechanical** failure of the system.

k. Transfer of system. The succeeding Contractor for Phase III construction, or the Government, shall take title to the complete surface and dewatering systems when the Contractor for Phase II completes his or her work. The facilities to be transferred include all dewatering wells, jet-eductor wells, **pumps**, engines, gear drives, piezometers, header pipe, valves, and all spare parts and standby equipment pertinent to the surface and groundwater control systems. The dewatering systems shall be continuously operated during the transfer of the system to either the Phase III Contractor or to the Government. The (succeeding) Contractor for Phase III work, or the Government, shall take title to the complete dewatering well, **jet-eductor**, and surface water control systems as installed when either assumes responsibility for maintaining the excavation dewatered. The Contractor (Phase II) shall not be responsible for removing any of the dewatering systems or grouting of wells or supplemental dewatering facilities, if any, installed by him or her, at the end of his or her contract or subsequently thereafter.

l. Measurement and payment.

(1) *Unwatering Phase I excavation.*

(a) No measurement will be made for unwatering Phase I excavation.

(b) Payment for unwatering Phase I excavation will be made at the lump sum price and shall constitute full compensation for furnishing all plant, labor, materials, and equipment necessary to unwater Phase I excavation.

(2) *Surface water control and sump pumping.*

(a) No measurement will be made for surface water control and sump pumping.

(b) Payment for surface water control and sump pumping will be made at the lump sum price and shall constitute full compensation for furnishing all plant, labor, materials, and equipment for surface water control and sump pumping, irregardless of the source of water.

(3) *Deep dewatering wells.*

(a) Dewatering wells will be measured for payment on the basis of each well successfully completed and accepted by the Government.

(b) Payment at the contract unit price for installation of dewatering wells shall constitute full compensation for furnishing all plant, labor, materials, and equipment for performing all operations necessary to install, develop, and test pump each well.

(4) *Dewatering turbine pumps, engines, and accessories.*

(a) Dewatering turbine pumps, engines, and accessories as specified on the drawings will be measured

for payment on the basis of each pump properly installed and fully operational.

(b) Payment at the contract unit price for installation of dewatering turbine pumps, engines, and accessories shall constitute full compensation for furnishing all plant, labor, materials, and equipment for furnishing and installing the pumps and engines.

(5) *Standby turbine pumps.*

(a) Standby turbine pumps will be measured for payment on the basis of each complete pump placed on the jobsite.

(b) Payment at the contract unit price for furnishing standby turbine pumps shall constitute full compensation for furnishing the pumps and placing in appropriate storage. Each standby turbine pump shall include all components shown on the drawings including, but not limited to, 130 feet of column pipe and shafting, pump bowls, suction pipe, pump head, gear drive, and flexible coupling.

(6) *Standby dieselpower units.*

(a) Standby diesel power units will be measured for payment on the basis of each complete power unit placed on the jobsite.

(b) Payment at the contract unit price for furnishing standby diesel power units shall constitute full compensation for furnishing all plant, labor, materials, and equipment for furnishing the diesel engines and placing in appropriate storage. Each standby diesel power unit shall include all components shown on the drawings including the 110-horsepower diesel engine with clutch power takeoff and fuel tank.

(7) *Well discharge header system.*

(a) No measurement will be made for the well discharge header system.

(b) Payment for the well discharge header system will be made at the lump sum price and shall constitute full compensation for furnishing all plant, labor, materials, and equipment necessary to install the system. The system includes, but is not limited to, header pipe, valves, fittings, outfall structures, and accessories.

(8) *Jet-eductor wells.*

(a) Jet-eductor wells will be measured for payment by the linear foot to the nearest foot from the (berm) ground surface to the bottom of the PVC pipe as installed.

(b) Payment at the contract unit price for installation of jet-eductor wells shall constitute full compensation for all plant, labor, header pipe, pumps, engines, tanks, valves, connections, materials, and equipment for performing all operations necessary to install the jet eductors and pumping system as shown on the drawings.

(9) *Piezometers.*

(a) M, R, S, T, and N piezometers will be measured for payment on the basis of each piezometer suc-

cessfully installed and tested.

(b) Payment at the contract unit price for installation of M, R, S, and T piezometers shall constitute full compensation for furnishing all plant, labor, materials, and equipment for performing all operations necessary to install, develop, and test the M, R, S, and T piezometers.

(c) Payment at the contract unit price for installation of N piezometers shall constitute full compensation for furnishing all plant, labor, materials, and equipment for performing all operations necessary to install, develop, and test N piezometers.

(10) *Testing, operation, and maintenance of dewatering systems.*

(a) No measurements will be made for testing, operation, and maintenance of the deep-well and jet-eductor well systems.

(b) Payment for testing, operations, and maintenance of the dewatering systems as specified will be made at the lump sum price and shall constitute full compensation for the duration of this contract and until the systems are transferred to the Phase III Contractor or the Government.

G-7. Example of type **B-3** specifications (dewatering).

a. General.

(1) The dewatering system shall be designed by the Contractor using accepted and professional methods of design and engineering consistent with the best modern practice.

(2) The dewatering system shall be of sufficient size and capacity as required to control ground and surface water flow into the excavation and to allow all work to be accomplished in the "dry."

(3) The Contractor shall control, by acceptable means, all water regardless of source and shall be fully responsible for disposal of the water. The Contractor shall confine all discharge piping and/or ditches to the available easement or to additional easement obtained by the Contractor. All necessary means for disposal of the water, including obtaining additional easement, shall be provided by the Contractor at no additional cost to the owner.

b. Design.

(1) Contractor shall obtain the services of a qualified dewatering "Expert" or a firm to provide a detailed plan for dewatering the excavation. Contractor shall submit his or her dewatering plan to the Engineer for review and approval. The material to be submitted shall include, but not be limited to, the following:

(a) The qualifications and experience of the selected dewatering "Expert" or the firm (minimum of 5 years of proven experience in the design of equivalent

system required).

(b) Drawings showing the soil conditions, stratification, and characteristics; location and size of berms, ditches, and deep wells; piezometers, well-points; and sumps and discharge lines or ditches.

(c) Capacities of pumps, prime movers, and standby equipment.

(d) Design calculations including design parameters and basis of such parameters, factors of safety, characteristics of pumping equipment, piping, etc.

(e) Detailed description of procedures for installing, maintaining, and monitoring performance of the system.

(2) Notice to Proceed issued by Engineer or receipt of the dewatering plans and data submitted by Contractor shall not in any way be considered to relieve the Contractor from full responsibility for errors therein or from the entire responsibility for complete and adequate design and performance of the system in controlling the groundwater in the excavated areas. The Contractor shall be solely responsible for proper design, installation, operation, maintenance, and any failures of any component of the system.

(3) The Contractor shall be responsible for the accuracy of the drawings, design data, and operational records required.

c. *Damages.* The Contractor shall be responsible for and shall repair without cost to the Owner any damage to work in place, other Contractor's equipment, utilities, residences, highways, roads, railroads, private and municipal well systems, and the excavation, that may result from his or her negligence, inadequate or improper design and operation of the dewatering system, and any mechanical or electrical failure of the dewatering system.

d. *Maintaining excavation in dewatered condition.* Subsequent to completion of excavation and during the installation of all work in the excavated area, the Contractor shall maintain the excavations to a dewatered condition. System maintenance shall include but not be limited to 24-hour supervision by personnel skilled in the operation, maintenance, and replacement of system components, and any other work required to maintain the excavation in a dewatered condition. Dewatering shall be a continuous operation and interruptions due to outages, or any other reason, shall not be permitted.

e. *System removal.* The Contractor shall remove all dewatering equipment from the site, including related temporary electrical service. All wells shall be removed or cut off a minimum of 3 feet below the final ground surface and capped. Holes left from pulling wells or wells that are capped shall be grouted in a manner approved by the Engineer.

The proponent agency of this publication is the Office of the Chief of Engineers, United States Army. Users are invited to send comments and suggested improvements on DA Form 2028 (Recommended Changes to Publications and Blank Forms) direct to **HQDA** (DAEN-ECE-G), WASH DC 20314.

By Order of the Secretaries of the Army, the Air Force, and the Navy:

Official:

ROBERT M. JOYCE

*Major General, United States Army
The Adjutant General*

Official:

JAMES H. DELANEY, *Colonel, USAF*
Director of Administration

JOHN A. WICKHAM, JR.
*General, United States Army
Chief of Staff*

CHARLES A. GABRIEL, *General, USAF*
Chief of Staff

W. M. ZOBEL
*Rear Admiral, CEC, US. Navy Commander, Naval Facilities
Engineering Command*

Distribution:

Army: To be distributed in accordance with DA Form 12-34B, requirements for TM 5-800 Series: Engineering and Design for Real Property Facilities.

Air Force: F

Navy: Special distribution.